



D0

Low Voltage Fuses

Low voltage fuse-links **766**

Fuse bases **770**

Accessories **775**

Fuse-disconnection units **778**



f @ in v
/etigroup

ETI
SWITCH TO
A SAFE FUTURE

D0 Low Voltage Fuse-Links

Fuse-Link D0

Rated current **2 - 100 A** / Fusing characteristics **gG**

D0 fuse-links are used as the most reliable protection of electrical installation, control and signal circuits against overload and short-circuit currents.

The whole system D0 contains a complete range of three physical sizes D01, D02 and D03 fuse-links, standard ceramic and new plastic bases, fuse disconnectors and all necessary accessories. It is dimensioned for rated voltages 400 V a.c. resp. 250 V d.c. with AC 50kA and DC 8kA rated breaking capacity.



The system D0 is intended to be used in residential, business and similar buildings. When it is used in industrial installations, it is necessary to take into account the requirements of the standard IEC 60664-1 concerning the insulation coordination for equipment within low-voltage systems.

All fuse-links have blown-fuse indicators which are visible through the screw cap when mounted. Fuse-links, fuse-bases, caps and fuse-disconnectors are tested and certified according to IEC 60269-3-1, DIN EN 60269-3, DIN VDE 0636-301, HD 630.3.1, DIN EN 60269-1, EN 60947-1 and EN 60947-3.

Technical data



Rated voltage U_n	400 V AC, 250 V DC
Rated current I_n	D01 2 - 16 A, D02 20 - 63 A, D03 80 - 100 A
Breaking capacity at 1,1 U_n	50 kA AC $\cos \phi = 0,1$
	8 kA DC $T = 15 \text{ ms}$
Fusing characteristics	gG
Standards	DIN EN 60269-1, IEC 60269-1:2005-04 (VDE 0636 Teil 10): 1999-11
	DIN EN 60269-3, IEC 60269-3:2003 (VDE 0636 Teil 30): 1995-12
	DIN EN 60269-3-1, IEC 60269-3-1: 2004-07
	(VDE 0636 Teil 301): 1998-01
	DIN VDE 0635/02.84

D01 for fuse base E 14

I_n [A]	Colour	Code No. gG		
2	pink	002211001	6	10/500
4	brown	002211002	6	10/500
6	green	002211003	6	10/500
10	red	002211004	6	10/500
13	black	002211006	6	10/500
16	grey	002211005	6	10/500



D02 for fuse base E 18

I_n [A]	Colour	Code No. gG		
20	blue	002212001	11	10/500
25	yellow	002212002	12	10/500
32	violet	002212006	13	10/500
35	black	002212003	13	10/500
40	black	002212007	13	10/500
50	white	002212004	13	10/500
63	copper	002212005	15	10/500

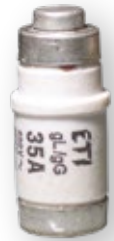

D03 for fuse base M 30 x 2

I_n [A]	Colour	Code No. gG		
80	silver	002213001	35	10/400
100	red	002213002	35	10/400



Dimensions

D01 gG for fuse base E 14

I_n [A]	dimension ØA
2	7,3
4	7,3
6	7,3
10	8,5
13	8,5
16	9,7

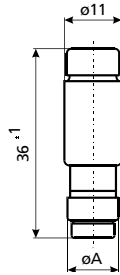

D02 gG for fuse base E 18

I_n [A]	dimension ØA
20	10,9
25	12,1
32	13,3
35	13,3
40	13,3
50	14,5
63	15,9

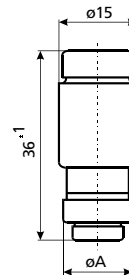

D03 gG for fuse base M 30 x 2

I_n [A]	dimension ØA
80	21,4
100	21,4

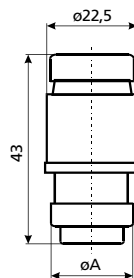

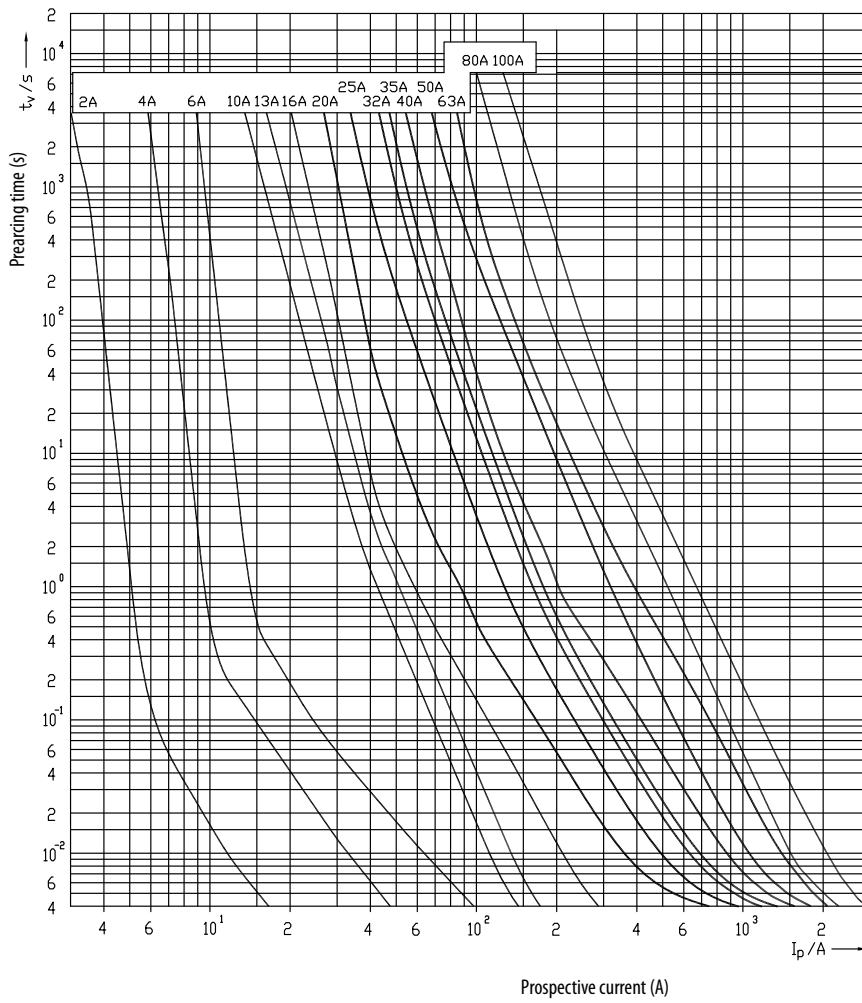

ETIFUSE: Streamline Your Fuse Selection - Interactive Online Tool

Cut-off current characteristics

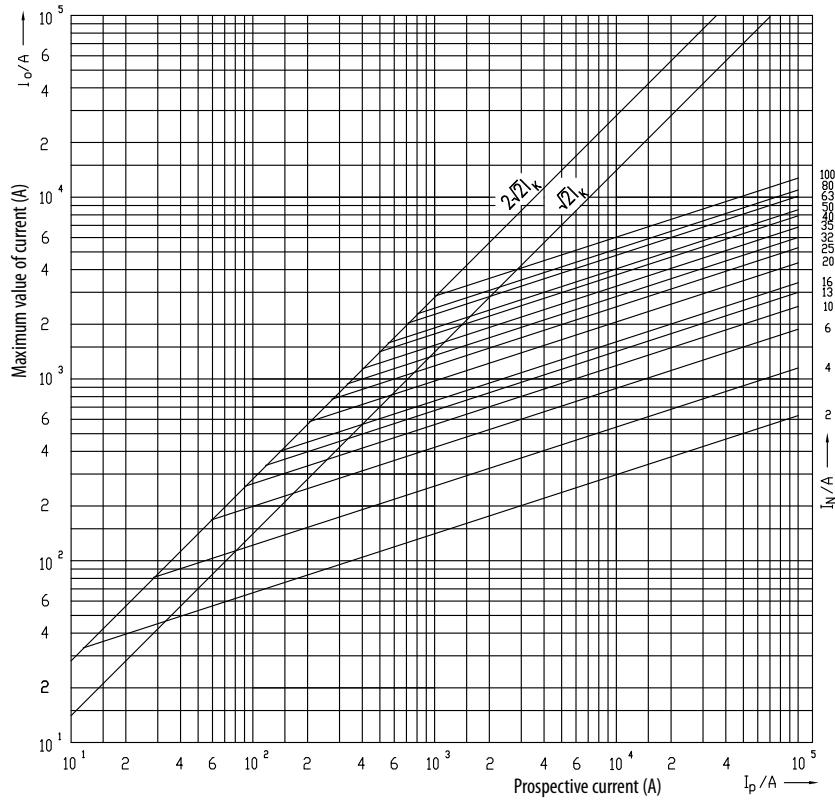

Melting energy characteristics $I^2 t$

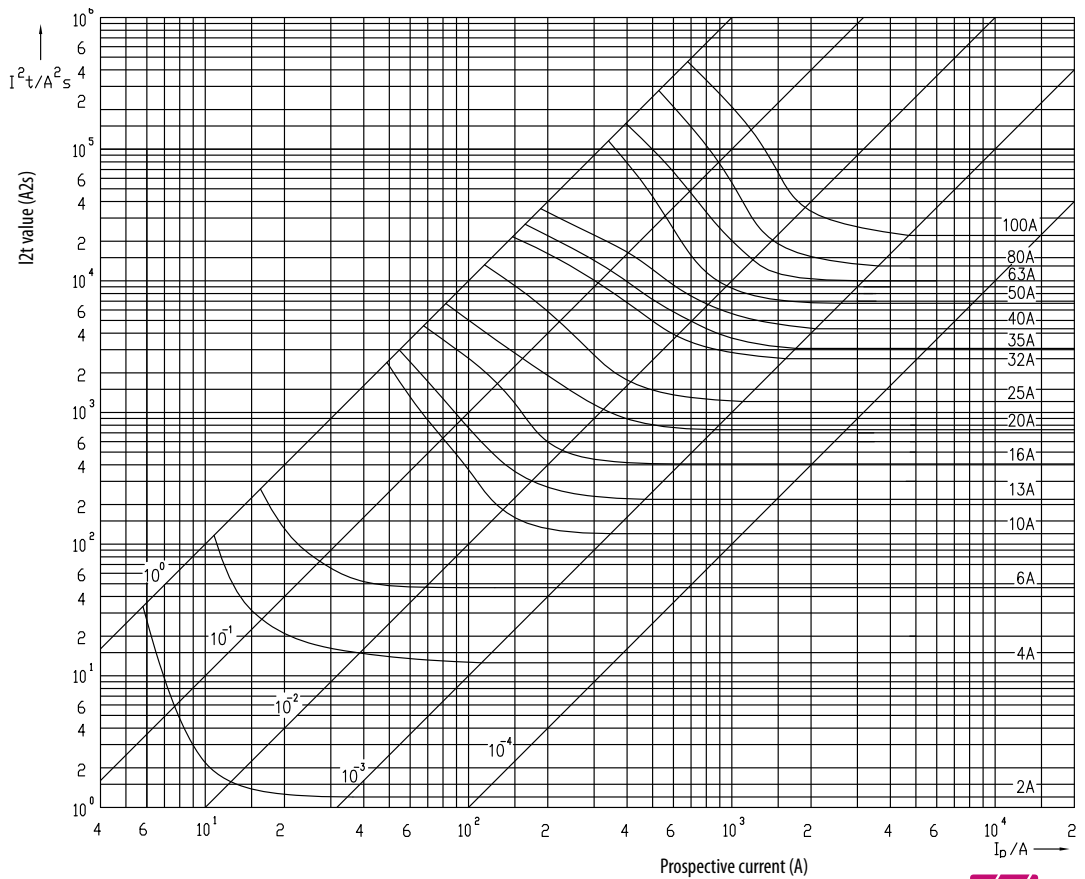

D0 Fuse Bases

Plastic Fuse Base PFB D0

Double input terminal - availability of connecting wire and busbars



Modular design - availability of assembling multi-pole versions on construction site

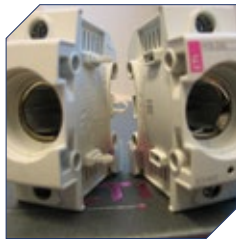

Two position snapper - enables easy replacement



All parts are made of firestop material (GW 960°C)

Front print - product data visible after installation in the cabinet

Compact housing design without additional covers - IP 20 protection class, faster assembling



More grip area for screwing caps



LED indication when fuse link operates - working also in case of open circuit at minimal wire capacitance
LED indication flashes when a fuse is blown

Contact material Cu - lower temperature rise, lower power dissipation

Technical data

	PFB D01	PFB D02
Fuse type	D01	D02
Versions	w/o indicator, LED indicator version	
Number of poles	1p, 3p	
Thread	E14	E18
Rated operational voltage Ue	400V a.c. / 250V d.c.	
Rated operational current Ie	16A	63A
Rated frequency	45-62Hz	
Rated conditional short-circuit current	50kA a.c. / 8kA d.c.	
Max power dissipation of the fuse-link (W)	2,5W	5,5W
LED indicator operating range	50V-400V a.c. / 50V-250V d.c.	
Glow wire test (GWFI)	960°C	
Terminals		
Screw	PZ2 M5	
Torque	2Nm	2,5Nm
Input terminal	1 ... 35mm ² + Busbar 16mm ²	
Output terminal	1 ... 25mm ²	
Humidity		
Operating ambient temperature	-5°C ... +40°C	
Store ambient temperature	-25°C ... +55°C	
Degree of protection (IEC 60529) with fuse - carrier	IP 20	
Mounting on EN 60715 rail	35mm	
Standards		
Standards	IEC 60269-3, VDE0636-3	
Approvals	VDE, OVE	

Fuse base PFB D01

Type	I _n [A]	Code No.	Number of poles		
PFB D01 1p	16	002510011	1	58	15/180
PFB D01 1p LED	16	002510012	1	58,5	15/180
PFB D01 3p	16	002510013	3	178	5/60
PFB D01 3p LED	16	002510014	3	179,5	5/60



Fuse base PFB D02

Type	I _n [A]	Code No.	Number of poles	g	
PFB D02 1p	63	002510021	1	64	15/180
PFB D02 1p LED	63	002510022	1	64,5	15/180
PFB D02 3p	63	002510023	3	194	5/60
PFB D02 3p LED	63	002510024	3	195,5	5/60



Connection kit

Type	Code No.	g	
Connection kit	002510001	30	300



Dimensions

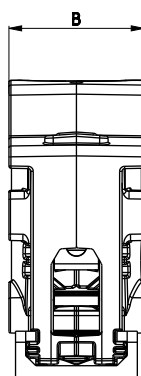
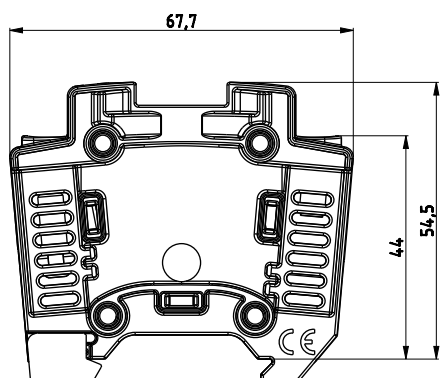

type	B [mm]
1p	26,8
3p	80,4

Ceramic Fuse Base

Rated current
16, 63 A

The fuse bases D0 are planned to be built into distribution boxes in domestic and public installations. Total security against parts under voltage is achieved by installing D0 fuse bases into domestic or industrial distribution boards. Ceramic fuse-bases are tested and certified according to IEC 60269-3-1, DIN EN 60269-1, DIN EN 60269-3 and DIN VDE 0636-301.

Advantages

- // modular construction
- // smaller weight and smaller height (66 mm) provide installation into the flush-mounting distribution boxes, the depth of which is 80 mm only
- // by the use of gauge-piece key it is possible to change the gauge rings under voltage
- // the possibility of simple substitution of base D0 1 with D0 2

Technical data

Rated voltage Un	400 V AC
Rated current In	D01 16 A, D02 63 A
Cross-section of connecting lead	D01 1 - 4 mm ² D02 1,5 - 25 mm ²
Connection clamp	with screw +- PZ
Standards	IEC 60269, EN 60269, DIN VDE 0636, SIST EN 60269

1-pole fuse base D0

Type	I _n [A]	Code No.	Screw	With protection cover	Without protection cover	Click-on mounting	Screw mounting	g	
D01N - K	16	002221011	E14	0		X		68	15/300
D01V - K	16	002221012	E14	0			X	66	15/300
D02N - K	63	002222011	E18	0		X		87	15/120
D02V - K	63	002222012	E18	0			X	80	15/120
D02N M5 - K	63	002222016	E18	0		X		82	15/120
D02V M5 - K	63	002222015	E18	0			X	80	15/120
D01N	16	002221001	E14		0	X		56	15/150
D01V	16	002221002	E14		0		X	59	15/150
D02N	63	002222001	E18		0	X		80	60/180
D02V	63	002222002	E18		0		X	77	60/180
D02N M5	63	002222006	E18		0	X		75	60/180
D02V M5	63	002222005	E18		0		X	72	60/180



3-pole fuse base D0

Type	I _n [A]	Code No.	Screw	With protection cover	Without protection cover	Click-on mounting	Screw mounting	g	📦
D01N/3 - K	16	002221021	E14	0		X		216	5/100
D01V/3 - K	16	002221020	E14	0			X	187	5/100
D02N/3 - K	63	002222021	E18	0		X		252	5/40
D02V/3 - K	63	002222020	E18	0			X	246	5/40
D02N/3 M5 - K	63	002222023	E18	0		X		237	5/40
D02V/3 M5 - K	63	002222022	E18	0			X	231	5/40
D01N/3	16	002221031	E14		0	X		176	5/50
D01V/3	16	002221030	E14		0		X	170	5/50
D02N/3	63	002222031	E18		0	X		235	5/50
D02V/3	63	002222030	E18		0		X	229	5/50
D02N/3 M5	63	002222033	E18		0	X		220	5/50
D02V/3 M5	63	002222032	E18		0		X	214	5/50



Dimensions

1-pole fuse base D0

Type	connections		cross-section of connecting lead [mm ²]	dimension A [mm]
	outlet	supply		
D01N - K			1,5 - 4	53
D01V - K			1,5 - 4	53
D02N - K			2,5 - 25	57
D02V - K			2,5 - 25	57
D02N M5 - K			2,5 - 25	57
D02V M5 - K			2,5 - 25	57
D01N			1,5 - 4	53
D01V			1,5 - 4	53
D02N			2,5 - 25	57
D02V			2,5 - 25	57
D02N M5			2,5 - 25	57
D02V M5			2,5 - 25	57

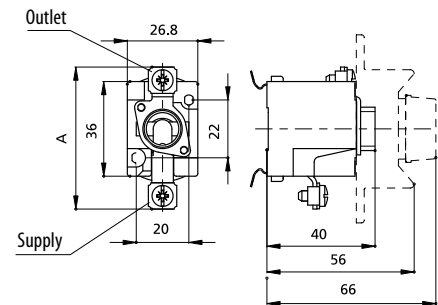

3-pole fuse base D0

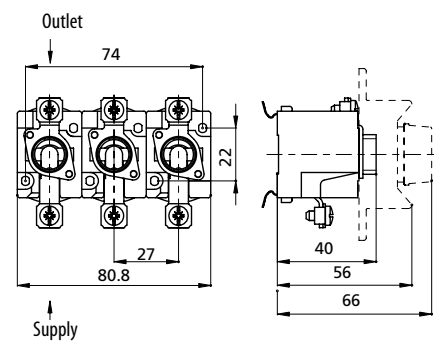

Type	connections		cross-section of connecting lead [mm ²]	dimension A [mm]
	outlet	supply		
D01N/3 - K			1,5 - 4	53
D01V/3 - K			1,5 - 4	53
D02N/3 - K			2,5 - 25	57
D02V/3 - K			2,5 - 25	57
D02N/3 M5 - K			2,5 - 25	57
D02V/3 M5 - K			2,5 - 25	57
D01N/3			1,5 - 4	53
D01V/3			1,5 - 4	53
D02N/3			2,5 - 25	57
D02V/3			2,5 - 25	57
D02N/3 M5			2,5 - 25	57
D02V/3 M5			2,5 - 25	57



D0 Accessories



Protection Cover

1-pole protection cover for fuse base

Type	Code No.	 g	
D01V, D01N	002251006	8	50/700
D02V, D02N	002251005	8	50/700



3-pole protection cover for fuse base

Type	Code No.	 g	
D01V/3, D01N/3	002251004	17	14/280
D02V/3, D02N/3	002251002	16	14/280



Dimensions

	A [mm]
ZP D01	17,3
ZP D02	21,1

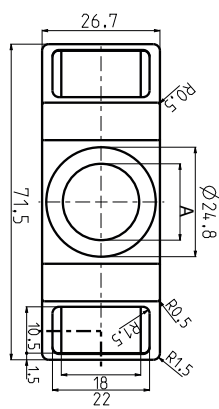

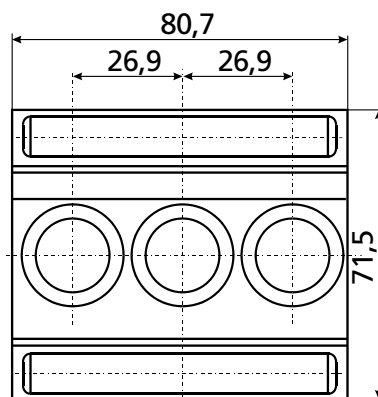

D01, D02

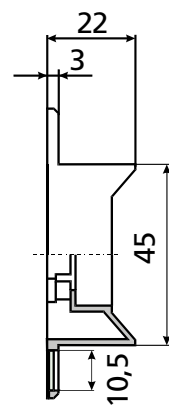

D01/3, D02/3





Gauge Piece

I_n [A]	Colour	Code No.		
2	pink	002241001	1	50/500
4	brown	002241002	1	50/500
6	green	002241003	1	50/500
10	red	002241004	1	50/500





V D02 for fuse base E 18

I_n [A]	Colour	Code No.		
2*	pink	002243001	1	50/500
4*	brown	002243002	1	50/500
6*	green	002243003	1	50/500
10*	red	002243004	1	50/500
16*	grey	002243005	1	50/500
20	blue	002242001	1	50/500
25	yellow	002242002	1	50/500
35	black	002242003	1	50/500
50	white	002242004	1	50/500



* For using fuse-links D01 and fuse bases D02.

Gauge piece key

Code No.		
002241000	17	20/120



Dimensions

V D01 for fuse base E 14

I_n [A]	dimension	
	$\varnothing A$	$\varnothing B$
2	7,9	12
4	7,9	12
6	7,9	12
10	9,1	12

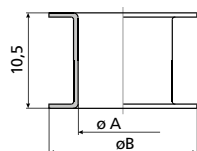

V D02 for fuse base E 18

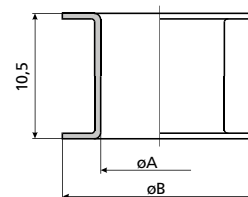

I_n [A]	dimension	
	$\varnothing A$	$\varnothing B$
2*	7,9	16,6
4*	7,9	16,6
6*	7,9	16,6
10*	9,1	16,6
16*	10,3	16,6
20	11,5	16,6
25	12,7	16,6
35	13,9	16,6
50	15,1	16,6



*For using fuse-links D01 and fuse bases D02.



Fuse Carrier D0

Fuse carrier D0

Type	Code No.	Screw		
KN D01	002231003	E 14	14	20/500
KN D02	002232003	E 18	17	20/500



Fuse carrier D0 - plastic

Type	Code No.	Screw		
PLK D01	002231010	E 14	9	10/500
PLK D02	002232008	E 18	11	10/500

Dimensions

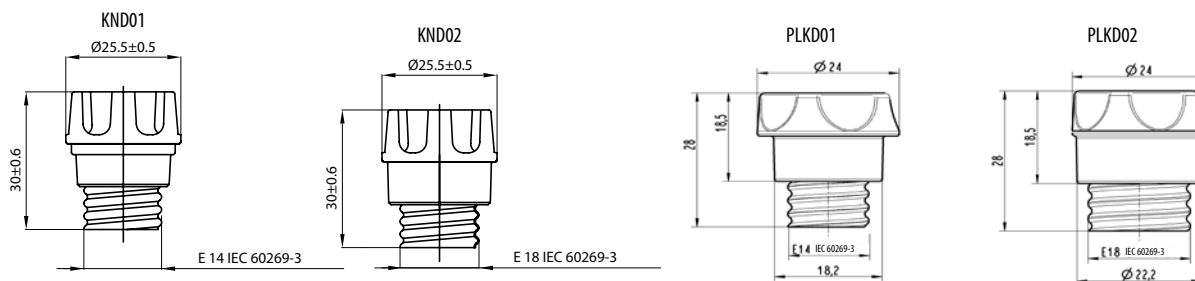

Special Holder

Special holder

Code No.		
002231000	1	25/300



D0 Fuse-Disconnection Units

Fuse-Switch Disconnecter VLD01

Rated current
2 - 6, 10, 16 A

Utilization category
AC22



Fuse-switch disconnecter is a protection device with an exchangeable for D01 fuse link. This system enables the following protecting advantages, concerning the D0 fuse:

- n Replacement of the fuse-link can be done with a movable holder, without danger of direct contact to the parts under voltage.
- n The device can be switched on without screwing, contact pressure is applied automatically by a spring.
- n Complete protection against touch by VBG 4.
- n In position 1 and 0, the fuse-link operation indicator is visible through a transparent window.



Technical data

Rated voltage U_n	230 V, 230/400 V, 400 V a.c.
Rated current I_n	2-6 A, 10 A, 13 A, 16 A
Rated frequency f_n	45-62 Hz
Utilization category	AC-22 A
Mechanical life	10.000 cycles
Electrical life	1500 cycles
Poles	1p, 1p+N, 2p, 3p, 3p+N
Standards	IEC/EN 60947-1 IEC/EN 60947-3 DIN EN 60947-1 VDE 0660-100 DIN EN 60947-3 VDE 0660-107 IEC 60269-1 Ed. 4.1 2009-07 IEC 60269-3 Ed. 4.0 2010-05
Terminal capacity	1,5 - 25mm ²

1-pole



I_n [A]	U_n [V]	Code No.		
6	230/400	002261001	67	12/108
10	230/400	002261002	67	12/108
13	230/400	002261004	67	12/108
16	230/400	002261003	67	12/108

1-pole + N



I_n [A]	U_n [V]	Code No.		
6	230	002261016	135	6/54
10	230	002261017	135	6/54
13	230	002261019	135	6/54
16	230	002261018	135	6/54





2-pole

I_n [A]	U_n [V]	Code No.	 g	
6	400	002261006	135	6/54
10	400	002261007	135	6/54
13	400	002261009	135	6/54
16	400	002261008	135	6/54

3-pole

I_n [A]	U_n [V]	Code No.	 g	
6	400	002261011	203	4/36
10	400	002261012	203	4/36
13	400	002261014	203	4/36
16	400	002261013	203	4/36

3-pole + N

I_n [A]	U_n [V]	Code No.	 g	
6	400	002261021	270	3/27
10	400	002261022	270	3/27
13	400	002261024	270	3/27
16	400	002261023	270	3/27



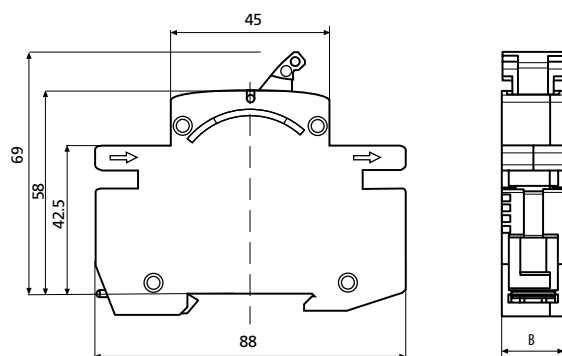

Dimensions



type	B [mm]
1p	17,5
1p+N	35
2p	35
3p	52,5
3p+N	70

Accessories for fuse-switch disconnecter VLD01

Holder

Accessories	Code No.		
holder/2-6A	002261028	6	15/600
holder/10A	002261029	6	15/600
holder/13A	002261027	6	15/600
holder/16A	002261030	6	15/600



Switch-disconnector-fuse STVD02

Rated current
63 A

Utilization category
AC 22

Switch-disconnector-fuse is a device which combines the functions of the switch and of the fuse DO. The system enables the following advantages of protection in comparison with the fuse DO:



- // The changing of the fuse-link without danger of direct touch of parts under voltage.
- // Snap-on mounting on rail according to EN 60715.
- // The complete protection against touch according to VBG 4.
- // The possibility of connecting supply from the upper or from the lower side.
- // It can be used as a main switch and tariff fuse in a single device.
- // Possibility of sealing in ON or OFF positions with or without fuse-link.

Technical data

Number of poles	1p, 1p+N, 2p, 3p, 3p+N
Rated voltage	230/400 V a.c., 110 V (2p) d.c.
Rated current	63 A
Rated breaking capacity	50 kA
Rated insulation voltage	400 V
Rated impulse resistance voltage	6000 V
Category of use according to DIN VDE 0638	AC 22(63 A), AC 23(35 A), DC 22 (63 A)
Category of use according to DIN E 60 947-3	AC-22A (63A/400V AC), AC-23A (35A/400V AC), DC-22B (63A/110V DC)
Mechanical life	8.500 cycles
Electrical life	1.500 cycles
Temperature of environment	-5°C ... +40°C
Air humidity	90%
Degree of protection	IP 00 according to DIN 40 050 IP 20 when mounted in distribution board
Standards	IEC/EN 60947-1 IEC/EN 60947-3 DIN EN 60947-1 VDE 0660-100 DIN EN 60947-3 VDE 0660-107 IEC 60269-1 Ed. 4.1 2009-07 IEC 60269-3 Ed. 4.0 2010-05
Terminal capacity	1,5 - 35mm ²
Possibility of sealing	in ON or OFF position



STVD02

Type	I _n [A]	Code No.	 g	
STV D02-1	63	002271001	119	12/96
STV D02-1N	63	002271002	238	6/48
STV D02-2	63	002271003	238	6/48
STV D02-3	63	002271004	357	4/32
STV D02-3N	63	002271005	476	3/24



Dimensions

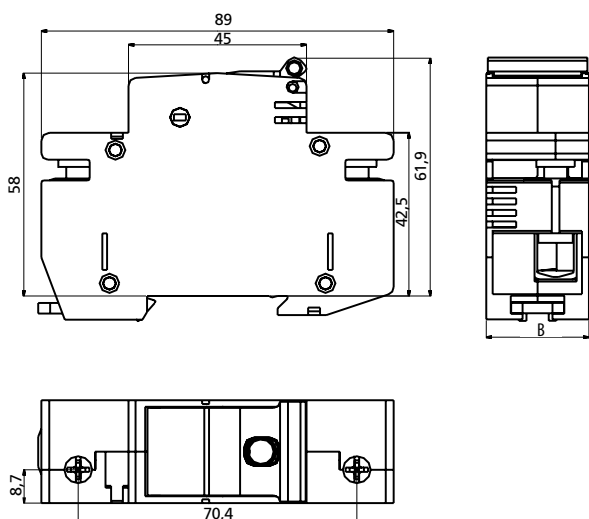

type	B [mm]
1p	26,8
1p+N	53,6
2p	53,6
3p	80,4
3p+N	107,2

Accessories for switch - disconnector - fuse STVD02

Auxiliary switch PS STV

Type	Code No.	Contacts	 g
PS STV - MD	002279001	1 x b, 1 x a	50
PS STV - 2M	002279002	2 x b	50
PS STV - 2D	002279003	2 x a	50

a... make contact
b... breake contact



Auxiliary switch PS STV is intended to be mounted with switches of series STV D02. The width of apparatus is 9 mm, other dimensions comply with STV D02 series switches. Auxiliary switch PS STV D02 serves for distant signalization of the state of contacts (on/off) of STV D02 switch, or for circuit control.

Technical data

Rated current I _n	AC12 (6A/230V AC)
	DC12 (1A/110V DC)
Rated conditional short circuit current	1 kA at 20 A fuse link
Standards	EN 62019

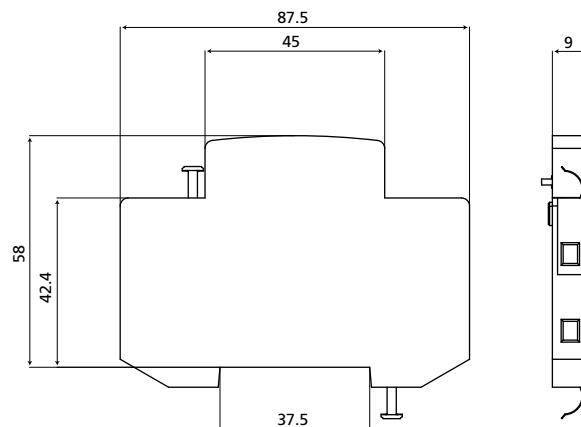

Gauge piece

I _n [A]	Colour	Code No.		
20	blue	002243010	0,8	15/300
25	yellow	002243011	0,6	15/300
35	black	002243012	0,5	15/300
50	white	002243013	0,4	15/300

Their function is to limit the use of D0 fuse-links to user prescribed rated currents. The gauge piece can be inserted into the holder, when the fuse holder is extracted from the housing.



Adapter

I _n [A]	Colour	Code No.		
6	green	002243018	2,5	20/200
10	red	002243019	2,5	20/200
16	grey	002243020	2,5	20/200

Its function is to allow the use of D01 fuse-links (2-16A) with the fuse-switch-disconnector STV D02.



STVD02 set

STVD02 set includes a switch-disconnector-fuse, gauge pieces of all sizes and adapters of all sizes.

STVD02 set

title	Code No.	
STV D02 1p set	002271101	12/96
STV D02 1p+N set	002271102	6/48
STV D02 2p set	002271103	6/48
STV D02 3p set	002271104	4/32
STV D02 3p+N set	002271105	3/24