



ETICON

Contactors

- Modular contactors for installation **236**
into distribution boards
- Bistable switches RBS **262**
- Miniature and motor contactors,
auxiliary contactors and overload
relays **278**
- Motor protective circuit breakers **354**

*Capacitor duty contactors are in the CP chapter, see page 378

ETICON

Modular Contactors For Installation Into Distribution Boards

Description

Modular contactors are used for installation in consumer units in dwellings, business premises, hotels, hospitals, shopping centres, sport centers, production halls, warehouses etc.

They are used for remote switching and automatic control of electric devices and equipment, such as:

- n lightning
- n all types of pumps
- n air-conditioning
- n electric heating
- n single-phase and three-phase motors

They excel in silent operation, long mechanical life time and high quality.

The contactors are designed for mounting on 35 mm mounting rail in accordance with the EN 60715 standard and they can be leaded by means of lead covers. The auxiliary contact block is available for signalization and ventilation module is available for preventing exceeded heating when contactors are used side-by-side.

All contactors have degree of protection IP20.

Besides the basic AC controlled types R20, R25, R40 and R63, types with increased silent operation RD20, RD25, RD40 and RD63 are available. Due to DC magnet and rectifier enable DC and AC voltage control. Surge arrestor is built in for over voltage protection.

Types R20-R, RD20-R, R25-R and RD25-R are upgraded versions of basic types of modular contactors. Besides basic functions they enable manual control with a handle.

Description of the handle positions:

- n A: the contactor functions as an installation contactor without manual control
- n O: permanently OFF
- n I: manual shifting the handle from position A to I causes the contactor to close; when control voltage is applied, the handle is automatically set to position A.

Types RD20-R and RD25-R are provided with a varistor for over voltage protection and a rectifier, which enables control with AC and DC voltage.

Contactors with manual control enable:

- n switching depending on tariff (selection of the most convenient tariff)
- n switching when control voltage is not applied

Technical specifications according to:

EN60947-4-1; EN60947-5-1; VDE 0660, IEC 947-4-1; IEC 947-5-1

Special terminals provide reliable connection with cables.



Contactors RD series are universal power supply AC/DC with built-in varistor surge protection. RD contactors produce less noise (DC coil inside)

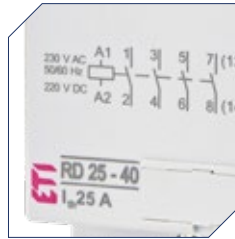

Spring-loaded latch ensures reliable mounting on DIN rail TH 35

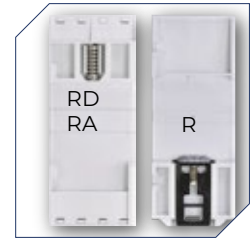

Contactors series R-R have operating mode switch:
 Automatic mode (normal operation with control circuit-coil)
 Manual mode (0 - permanently open, I - constantly closed).



In manual mode constantly close operation I presence of voltage on control circuit-coil returns contactor in automatic mode operation.

Contact status can be monitored visually or remote by auxiliary contacts



Silver contacts provide the best conductivity and lowest contact resistance



Spring loaded contacts to reduce bouncing effect and prolong contact life time



Specially designed mechanism consisting of two movable cores significantly reduces the noise level at switching

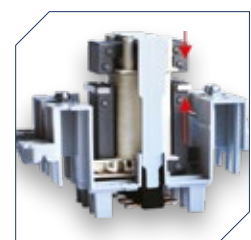



Modular contactors RA

RA series contactors are used for remote control and automatic monitoring of electrical devices and equipment in both industrial and domestic settings (lighting systems, heating and ventilation systems, switching of small power motors, etc.). They feature a modular design (1, 2, and 3 modules). The range of nominal currents is from 20 to 63 A. Coil control voltage - 230V AC.

Features:

- Low power consumption;
- High switching speed;
- Sealing Possibility;
- Supports additional contact blocks;
- Versatile applications across different industries.

Technical data

			RA 20 (2p)	RA 25 (2p)	RA 25 (4p)	RA 32 (2p)	RA 32 (4p)	RA 40 (4p)	RA 63 (4p)	
Rated insulation voltage	U_i	V	440							
Thermal rated current	I_{th}	A	20	25	25	32	32	40	63	
Protection rating according to IEC / EN 60529			IP20							
Number of modules			1	1	2	1	2	3		
Operating temperature / Storage temperature		°C	-15...+55 / -30...+80							
Pollution degree			3							
Permissible humidity			95 % RH @ +55 °C							
Minimum load values			≥ 17V; ≥ 50 mA							
Power loss per pole		W	1,7	2,0	2,2	2,5	2,5	4,0	8,0	
Backup fuse	I_v	A	20	25	25	32	32	63	80	
Noise level during operation		dB	30	30	30	30	30	30	30	
Rated impulse voltage	U_{imp}	kV	4							
Rated frequency	f	Hz	50/60							
Coil control voltage	U_c	V	230 (AC)							
Switching time:	make time	ms	15-25	15-25	10-30	15-25	10-30	15-20		
	release time		10-30	10-30	10-30	10-30	10-30	35-45		
Coil consumption:	during activation	VA / W	12/10	12/10	33/25	12/10	33/25	15,4/6	15,4/6	
	during operation		2,8/1,2	2,8/1,2	5,5/1,6	2,8/1,2	5,5/1,6	7,7/3	7,7/3	
Mechanical life			3x106	3x106	3x106	3x106	3x106	3x106	3x106	
Electrical life	• AC-1, AC-7a, AC-21	cycles	200 000		200 000	150 000	150 000	100 000		
	• AC-3, AC-7b, AC-23		300 000		500 000	300 000	500 000	150 000		
Switching capacity for AC-1, AC-7a, AC-21	1-phase connection, 230 V	P_e	kW	4	5,4	5,4	7	7	8,7	13,3
	3-phase connection, 230 V			-	-	9	-	12	16	24
	3-phase connection, 400 V			-	-	16	-	21	26	40
Switching capacity for AC-3, AC-7b, AC-23	1-phase connection, 230 V	P_e	kW	NO:1,3 / NC:0,75	1,3	1,3	NO:1,3 / NC:0,75	1,3	3,7	5
	3-phase connection, 230 V			-	-	2,2	-	2,2	5,5	8,5
	3-phase connection, 400 V			-	-	4	-	4	11	15
Maximum switching frequency (AC-1, AC-7, AC-21)			600 / year							
Maximum switching frequency (no load)			3000 / year							
Magnetic coil	solid or stranded		mm ² 1-2,5							
	Insulation stripping length 	mm	7							
	Tightening torque	Nm	0,6 (PZ1) M3							
Main connector	solid	mm ²	1 - 10							
	stranded	mm ²	1 - 6							
	Insulation stripping length 	mm	9							
	Tightening torque	Nm	1,2 (PZ1) M3,5							
Installation of multiple contactors side by side:	при t ≤ 40 oC		max 3 contactors							
	при t 40...55 oC		max 2 contactors ¹⁾							
standards			IEC/EN 61095, IEC/EN 60947-4-1, IEC/EN 60947-5-1							

¹⁾ At temperatures above +40°C, and also when using more than two contactors in a row, it is necessary to install an intermediate spacer IKV (code 2464074) to ensure an air gap.

Rated operating current DC-1 (L/R ≤ 1 ms) U_e=24/ 60/ 110/ 220V DC

U _e /I _e	RA 20 (2p)				RA 25 (2p)				RA 25 (4p)				RA 32 (2p)				RA 32 (4p)				RA 40 (4p)				RA 63 (4p)										
	(V)	24	60	110	220	(V)	24	60	110	220	(V)	24	60	110	220	(V)	24	60	110	220	(V)	24	60	110	220	(V)	24	60	110	220	(V)	24	60	110	220
1p	(A)	20	10	6	0,6	(A)	25	15	6	0,6	(A)	25	15	6	0,6	(A)	32	15	6	0,6	(A)	32	15	6	0,6	(A)	40	18	4	1,2	(A)	63	20	4	1,2
2p*	(A)	20	15	10	6	(A)	25	20	10	6	(A)	25	20	10	6	(A)	32	20	10	6	(A)	32	20	10	6	(A)	40	32	10	8	(A)	63	34	10	8
3p*											(A)	25	25	20	15						(A)	32	32	20	15	(A)	40	40	30	20	(A)	63	30	35	30
4p*	* Series connection																																		

2-pole, 1 module (17,5 mm), 20 A (AC1, 400 V)

Type	Un,V (AC)	Code No.	Wiring diagram	Contacts		g	Box
				NO	NC		
RA 20-20 230V AC	230V	002464092		2	-	130	10/80
RA 20-11 230V AC	230V	002464097		1	1	130	10/80

Important: At an ambient temperature of t ≤ +40 °C, the maximum number of contactors that can be installed side by side is 3 units. At temperatures from +40 to +55 °C, the maximum is 2 units. When using more units, it is necessary to install an intermediate spacer IKV, Code No. 002464074.

2-pole, 1 module (17,5 mm), 25 A (AC1, 400 V)

Type	Un,V (AC)	Code No.	Wiring diagram	Contacts		g	Box
				NO	NC		
RA 25-20 230V AC	230V	002464093		2	-	130	10/80

Important: At an ambient temperature of t ≤ +40 °C, the maximum number of contactors that can be installed side by side is 3 units. At temperatures from +40 to +55 °C, the maximum is 2 units. When using more units, it is necessary to install an intermediate spacer IKV, Code No. 002464074.

4-pole, 2 modules (35 mm), 25 A (AC1, 400 V)

Type	Un,V (AC)	Code No.	Wiring diagram	Contacts		g	Box
				NO	NC		
RA 25-40 230V AC	230V	002464094		4	0	240	5/40
RA 25-22 230V AC	230V	002464089		2	2		

Important: At an ambient temperature of t ≤ +40 °C, the maximum number of contactors that can be installed side by side is 3 units. At temperatures from +40 to +55 °C, the maximum is 2 units. When using more units, it is necessary to install an intermediate spacer IKV, Code No. 002464074.

2-pole, 1 module (17,5 mm), 32 A (AC1, 400 V)

Type	Un,V (AC)	Code No.	Wiring diagram	Contacts		g	Box
				NO	NC		
RA 32-20 230V AC	230V	002464075		2	-	130	10/80

Important: At an ambient temperature of t ≤ +40 °C, the maximum number of contactors that can be installed side by side is 3 units. At temperatures from +40 to +55 °C, the maximum is 2 units. When using more units, it is necessary to install an intermediate spacer IKV, Code No. 002464074.

4-pole, 2 modules (35 mm), 32 A (AC1, 400 V)

Type	Un,V (AC)	Code No.	Wiring diagram	Contacts		g	Box
				NO	NC		
RA 32-40 230V AC	230V	002464076		4	-	240	5/40

Important: At an ambient temperature of t ≤ +40 °C, the maximum number of contactors that can be installed side by side is 3 units. At temperatures from +40 to +55 °C, the maximum is 2 units. When using more units, it is necessary to install an intermediate spacer IKV, Code No. 002464074.



2-pole, 2 module (17,5 mm), 40 A (AC1, 400 V)

Type	Un,V (AC)	Code No.	Wiring diagram	Contacts		g	
				NO	NC		
RA 40-20 230V AC	230V	002464079		2	-	240	3/75

Important: At an ambient temperature of $t \leq +40^\circ\text{C}$, the maximum number of contactors that can be installed side by side is 3 units. At temperatures from $+40$ to $+55^\circ\text{C}$, the maximum is 2 units. When using more units, it is necessary to install an intermediate spacer IKV, Code No. 2464074.

4-pole, 3 modules (52,5 mm), 40 A (AC1, 400 V)

Type	Un,V (AC)	Code No.	Wiring diagram	Contacts		g	
				NO	NC		
RA 40-40 230V AC	230V	002464095		4	-	400	5/50

Important: At an ambient temperature of $t \leq +40^\circ\text{C}$, the maximum number of contactors that can be installed side by side is 3 units. At temperatures from $+40$ to $+55^\circ\text{C}$, the maximum is 2 units. When using more units, it is necessary to install an intermediate spacer IKV, Code No. 2464074.

4-pole, 3 modules (52,5 mm), 63 A (AC1, 400 V)

Type	Un,V (AC)	Code No.	Wiring diagram	Contacts		g	
				NO	NC		
RA 63-40 230V AC	230V	002464096		4	-	400	5/50
RA 63-22 230V AC	230V	002464098		2	2		

Important: At an ambient temperature of $t \leq +40^\circ\text{C}$, the maximum number of contactors that can be installed side by side is 3 units. At temperatures from $+40$ to $+55^\circ\text{C}$, the maximum is 2 units. When using more units, it is necessary to install an intermediate spacer IKV, Code No. 2464074.

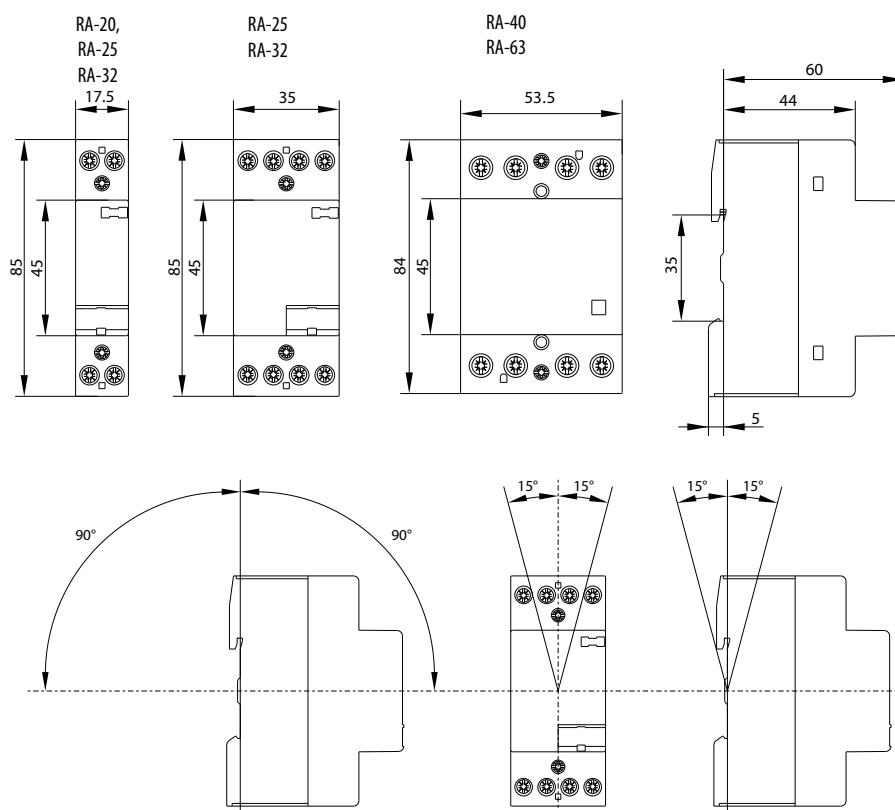
**Overall dimensions / mounting position.**

Modular contactors R

Data according to IEC 947-4-1, IEC 947-5-1, VDE 0660, EN 60947-4-1, EN 60947-5-1

Type			R20	R25 (2p)	R25 (4p)	R40	R63	RH11	
Main Contacts									
Rated insulation voltage UI	V AC		4402)	4402)	4402)	4402)	4402)	4402)	
Rated operation voltage Ue	V AC		250	440	440	440	440	440	
Frequency of operations with AC1, AC3	1/h		300	300	300	600	600	600	
Mechanical life	S x 106		1	1	1	1	1	1	
Utilization category AC1									
Rated operational current Ie (=Ith)	open at 60°C	A	20	25	25	40	60	-	
Contact life	S x 106		0,1	0,1	0,1	0,1	0,1	-	
Minimum switch voltage	V/mA		24/100	24/100	24/100	24/100	24/100	17/5	
Short time current	10s-current	A	72	72	72	216	240	-	
Power loss per pole at Ie/AC1	W		2	3	2	3	7	0,5	
Utilization category AC3									
Switching of three-phase motors									
Rated operational current Ie		A	-	-	9	27	30	-	
Rated operational power of three-phase motors 50-60Hz	220V	kW	-	-	2,2	7,5	8	-	
	230-240V	kW	1,14)		2,5	8	8,5	-	
	380-415V	kW	-	-	4	12,5	15	-	
Contact life AC 3	S x 106		-	-	0,15	0,15	0,15	-	
Power consumption of coils									
AC operated	inrush sealed	VA	7-9	7-9	20-25	33-45	33-45	-	
		VA	2,2-4,2	2,2-4,2	4-6	6-8	6-8	-	
		W	0,8-1,6	0,8-1,6	1,5-2,5	2-3,3	2-3,3	-	
Operation range of coils in multiples of control voltage Us	(-40...+40°C)		0,85-1,1	0,85-1,1	0,85-1,1	0,85-1,1	0,85-1,1	-	
Short-circuit protection									
Coordination-type "1" according to IEC 947-4-1 max. fuse size	gG/gL	A	35	35	35	63	80	-	
Cable cross-sections									
Main connector	solid or stranded		mm ²	1,5-10	1,5-10	1,5-10	2,5-25	2,5-25	0,5-2,53)
	flexible		mm ²	1,5-6	1,5-6	1,5-6	2,5-16	2,5-16	0,5-2,53)
	flexible with multicore cable end		mm ²	1,5-6	1,5-6	1,5-6	2,5-16	2,5-16	0,5-1,5
Clamps per pole			1	1	1	1	1	2	
Magnetic coil	solid or stranded		mm ²	0,75-2,5	0,75-2,5	0,75-2,5	0,75-2,5	0,75-2,5	-
	flexible		mm ²	0,5-2,5	0,5-2,5	0,5-2,5	0,5-2,5	0,5-2,5	-
	flexible with multicore cable end		mm ²	0,5-1,5	0,5-1,5	0,5-1,5	0,5-1,5	0,5-1,5	-
Clamps per pole			1	1	1	1	1	-	
Auxiliary Contacts									
Rated insulation voltage UI1)	V AC		-	-	-	-	-	4402)	
Thermal rated current Ith	40°C	[A]	-	-	-	-	-	10	
Ambient temperature	60°C	[A]	-	-	-	-	-	6	
Utilization category AC 15									
Rated operational current Ie	220-240V	[A]	-	-	-	-	-	3	
	380-415V	[A]	-	-	-	-	-	2	
	440V	[A]	-	-	-	-	-	1,6	
Utilization category DC13									
Rated operational current Ie per pole	24-60V	[A]	-	-	-	-	-	2	
	110V	[A]	-	-	-	-	-	0,4	
	220V	[A]	-	-	-	-	-	0,1	
Short circuit protection									
short-circuit current 1kA, contact welding not accepted max. fuse size	gG/gL	[A]	-	-	-	-	-	10	
Switching time at control voltage Us±10%									
	make time	ms	7-16	7-16	9-15	11-15	11-15	-	
	release time		6-12	6-12	4-8	6-13	6-13	-	
	arc duration		10-15	10-15	10-15	10-15	10-15	-	
Noise level (operation) acc. to EN ISO 3744 from front, distance 0,5 m		dB	16	16	8	<4	8	<4	





1) Suitable for: earthed-neutral systems, overvoltage category I to IV, pollution degree 3 (standard-industry): Uimp 8kV.

2) Suitable for: earthed-neutral systems, overvoltage category I to III, pollution degree 3 (standard-industry): Uimp 4kV.









3) Maximum cable cross-section with prepared conductor.

4) ACSb motor 2-pole 230 V 1,1 kW.









1-pole, 1 module (17,5 mm), 25 A (AC1, 230V)

Type	Code No.	Wiring diagram	 g	
R 25-10-24V	002463507		130	12
R 25-10-230V	002463500		130	12







2-pole, 1 module (17,5 mm), 20 A (AC1, 230V)

Type	Code No.	Wiring diagram	 g	
R 20-20 230V	002461210		130	12
R 20-20 24 V	002461211		130	12
R 20-11 230V	002461220		130	12
R 20-11 24 V	002461221		130	12
R 20-02 230V	002461230		130	12
R 20-02 24 V	002461231		130	12





2-pole, 1 module (17,5 mm), 25 A (AC1, 230V)

Type	Code No.	Wiring diagram	 g	
R 25-20-24V	002463501		130	12
R 25-20 230V	002463502		130	12
R 25-11 24V	002463503		130	12
R 25-11 230V	002463504		130	12
R 25-02 24V	002463505		130	12
R 25-02 230V	002463506		130	12

2 pole, 2 modules (35 mm), 63 A(AC1, 400 V)



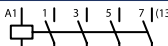
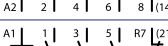
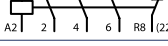
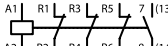
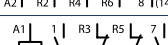
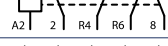
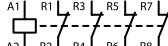
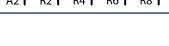

Type	Code No.	Wiring diagram	 g	
R 63-20 230V	002463482		240	6/60
R 63-20 24V	002463483		240	6/60
R 63-11 230V	002463484		240	6/60
R 63-11 24V	002463485		240	6/60

4-pole, 2 modules (35 mm), 25 A (AC1, 400 V)

Type	Code No.	Wiring diagram	 g	
R 25-40 230V	002462310		220	6
R 25-40 24 V	002462311		220	6
R 25-31 230V	002462320		220	6
R 25-31 24 V	002462321		220	6
R 25-13 230V	002462330		220	6
R 25-13 24 V	002462331		220	6
R 25-22 230V	002462340		220	6
R 25-22 24 V	002462341		220	6
R 25-04 230V	002462350		220	6
R 25-04 24 V	002462351		220	6



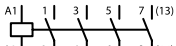
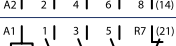
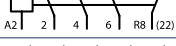
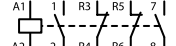
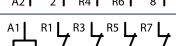
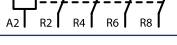

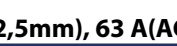

4-pole, 3 modules (52,5 mm), 40 A (AC1, 400 V)

Type	Code No.	Wiring diagram		
R 40-40 230V	002463410		360	4
R 40-40 24 V	002463411		360	4
R 40-31 230V	002463420		360	4
R 40-31 24 V	002463421		360	4
R 40-22 230V	002463430		360	4
R 40-22 24 V	002463431		360	4
R 40-04 230V	002463440		360	4
R 40-04 24 V	002463441		360	4



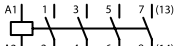
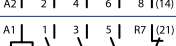
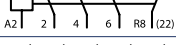
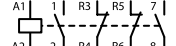
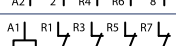
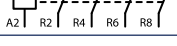

4 pole, 3 modules (52,5mm), 63 A(AC1, 400 V)

Type	Code No.	Wiring diagram		
R 63-40 230V	002463450		360	4
R 63-40 24 V	002463451		360	4
R 63-31 230V	002463460		360	4
R 63-31 24 V	002463461		360	4
R 63-22 230V	002463470		360	4
R 63-22 24 V	002463471		360	4
R 63-04 230V	002463480		360	4
R 63-04 24 V	002463481		360	4





Auxiliary contactor block for contactors R25, R40, R63 (max. 1 piece)

Type	Code No.	Wiring diagram		
RH 11	002461101		26	3

*Not available for 1 modules size R contactors, only for 2 and above!





Sealing cover

Type	Code No.	For use with		
P721	002461110	R 25 (4p)	2	10
P690	002461120	R 40..., R 63...	3	10



Distance piece

Type	Code No.	For use with		
P730	002461130	R20-R63	12	10



Dimensions

R20

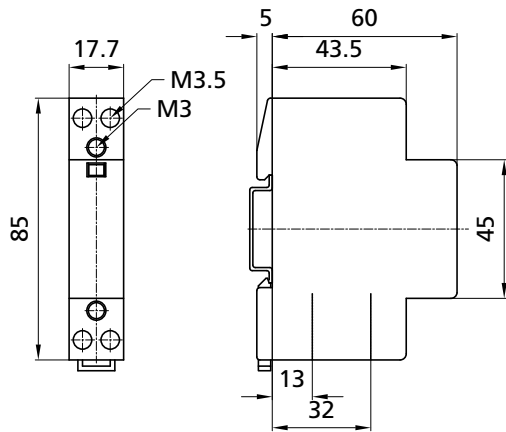

Distance piece

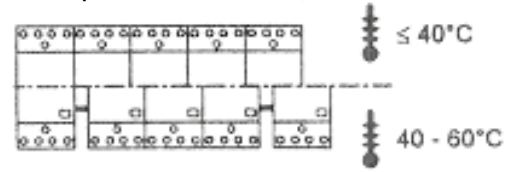

Distance piece is used where ambient temperature is higher than 40°C . Piece width is 1/2 module (8,8 mm)

R25

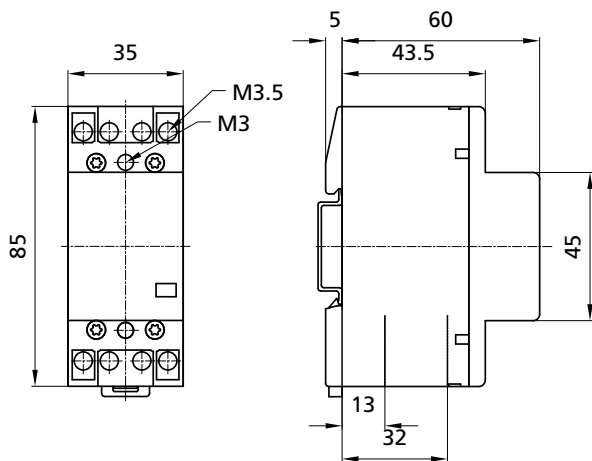

R40,R63

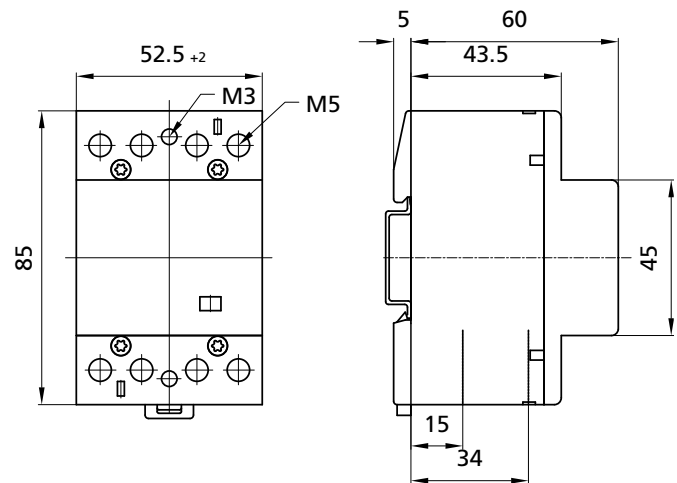

RH11

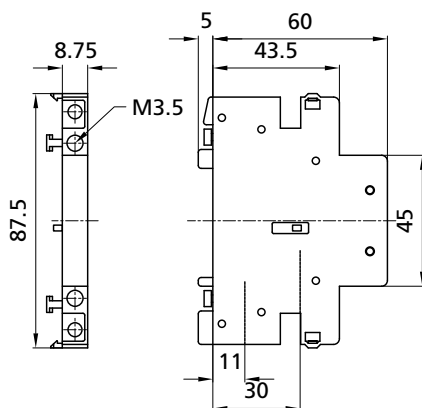

Utilization category DC1 (Switching of resistive load)

time constant L/R ≤ 1ms	NO contacts				NC contacts				
	1 pole	2 poles in series	3 poles in series	4 poles in series	1 pole	2 poles in series	3 poles in series	4 poles in series	
	(A)	(A)	(A)	(A)	(A)	(A)	(A)	(A)	
R20	24V DC	20	20	-	-	15	15	-	-
	48V DC	18	20	-	-	13,5	15	-	-
	60V DC	17	20	-	-	12,5	15	-	-
	110V DC	4	10	-	-	3	7,5	-	-
	220V DC	0,4	-	-	-	0,3	-	-	-
R25	24V DC	25	25	25	25	18,5	18,5	18,5	18,5
	48V DC	22	25	25	25	16,5	18,75	18,5	18,5
	60V DC	18	25	25	25	13,5	18,75	18,5	18,5
	110V DC	5	16	25	25	3,5	12	18,5	18,5
	220V DC	0,5	4	10	15	0,4	3	7,5	11
R40	24V DC	40	40	40	40	30	30	30	30
	48V DC	25	40	40	40	18,5	30	30	30
	60V DC	19	30	40	40	14	24,5	30	30
	110V DC	7	17	31	40	5	12,5	23	30
	220V DC	0,7	5	15	20	0,5	3,5	11	15
R63	24V DC	63	63	63	63	47	47	47	47
	48V DC	26	44	63	63	19,5	33	47	47
	60V DC	21	36	63	63	15,5	27	47	47
	110V DC	8	18	34	63	6	13,5	25,5	47
	220V DC	0,7	6	16	21	0,5	4,5	12	15,5

Utilization category DC3 & DC5 (Switching of inductive loads)

time constant L/R ≤ 15ms	NO contacts				NC contacts				
	1 pole	2 poles in series	3 poles in series	4 poles in series	1 pole	2 poles in series	3 poles in series	4 poles in series	
	(A)	(A)	(A)	(A)	(A)	(A)	(A)	(A)	
R20	24V DC	10	20	-	-	7,5	15	-	-
	48V DC	4	15	-	-	3	11	-	-
	60V DC	3	12	-	-	2	9	-	-
	110V DC	0,8	4	-	-	0,6	3	-	-
	220V DC	-	-	-	-	-	-	-	-
R25	24V DC	15	25	25	25	11	18,5	18,5	18,5
	48V DC	5	17	25	25	3,5	12,75	18,5	18,5
	60V DC	4	13	25	25	3	9,5	18,5	18,5
	110V DC	1	5	15	25	0,7	3,5	11	18,5
	220V DC	0,1	0,5	10	8	0,075	0,375	2	6
R40	24V DC	23	40	40	40	17	30	30	30
	48V DC	10	23	40	40	7,5	17	30	30
	60V DC	5	15	30	40	3,5	11	22,5	30
	110V DC	1,5	5	15	40	1,1	3,5	11	30
	220V DC	0,3	1	4	10	0,2	0,75	3	7,5
R63	24V DC	25	45	63	63	18,5	33,5	47	47
	48V DC	10	25	45	63	7,5	18,5	33,5	47
	60V DC	5	15	30	63	3,5	11	22,5	47
	110V DC	1,5	5	15	45	1,1	3,5	11	33,5
	220V DC	0,3	1	4	10	0,2	0,75	3	7,5

Switching of Lamps

Lamp Type	Power [W]	Current [A]	Capacitors μF	Max. lamps per pole at 230V 50Hz			
				R20	R25	R40	R63
Incandescent lamps	60	0,27	-	22	28	58	85
	100	0,45	-	13	17	35	51
	200	0,91	-	7	8	17	25
	300	1,36	-	4	5	11	16
	500	2,27	-	3	3	7	10
	1000	4,5	-	1	1	3	5
Fluorescent lamps, uncompensated or serial compensated	11	0,16	-	60	75	210	310
	18	0,37	2,7	25	30	90	140
	24	0,35	2,5	25	30	90	140
	36	0,43	3,4	20	25	70	140
	58	0,67	5,3	14	17	45	70
	65	0,67	5,3	13	16	40	65
Fluorescent lamps, dual-connection	85	0,8	-	11	14	35	60
	11	0,07	-	2x100	2x110	2x220	2x250
	18	0,11	-	2x50	2x55	2x130	2x200
	24	0,14	-	2x40	2x44	2x110	2x160
	36	0,22	-	2x30	2x33	2x70	2x100
	58	0,35	-	2x20	2x22	2x45	2x70
Fluorescent lamps, parallel compensated	65	0,35	-	2x15	2x16	2x40	2x60
	85	0,47	-	2x10	2x11	2x30	2x40
	11	0,16	2,0	30	30	100	140
	18	0,37	2,0	20	20	70	90
	24	0,35	3,0	15	15	55	75
	36	0,43	4,5	10	10	38	51
	58	0,67	7,0	6	6	25	30
	65	0,67	7,0	5	5	24	28
	85	0,8	8,0	4	4	18	23

Switching of Lamps

Lamp Type	Power [W]	Current [A]	Capacitors μF	Max. lamps per pole at 230V 50Hz			
				R20	R25	R40	R63
Fluorescent lamps, with serial electronic	18	0,09	-	40	40	100	150
	36	0,16	-	20	20	50	75
	58	0,25	-	15	15	30	55
	2x18	0,17	-	2x20	2x20	2x50	2x60
	2x36	0,32	-	2x10	2x10	2x25	2x30
	2x58	0,49	-	2x7	2x7	2x15	2x20
Transformers for metal halid low voltage lamps	20	-	-	40	52	110	174
	50	-	-	20	24	50	80
	75	-	-	13	16	35	54
	100	-	-	10	12	27	43
	150	-	-	7	9	19	29
	200	-	-	5	5	14	23
	300	-	-	3	4	9	14
Mercury-vapour lamps (high pressure lamps), uncompensated e. g. HQL, HPL	50	0,61	-	16	18	38	55
	80	0,8	-	12	14	28	40
	125	1,15	-	8	9	20	28
	250	2,15	-	4	5	11	15
	400	3,25	-	3	4	7	10
	700	5,4	-	1	2	4	6
	1000	7,5	-	1	1	3	4
Mercury-vapour lamps (high pressure lamps), compensated e. g. HQL, HPL	50	0,28	7	7	7	32	46
	80	0,41	8	5	5	25	35
	125	0,65	10	3	3	16	22
	250	1,22	18	2	2	8	12
	400	1,95	25	1	1	5	7
	700	3,45	45	1	1	3	4
	1000	4,8	60	-	-	2	3
Metal halide lamps uncompensated e. g. HQL, HPI, CDM	35	0,53	-	22	24	45	65
	70	1	-	12	14	24	35
	150	1,8	-	6	8	13	18
	250	3	-	4	5	8	12
	400	3,5	-	3	4	6	10
	1000	9,5	-	1	1	2	4
	2000	16,5	-	-	-	1	2
400 V per pole	2000	10,5	-	-	-	1	2
	3500	18	-	-	-	-	1
Metal halide lamps compensated e. g. HQL, HPI	35	0,25	6	8	8	38	50
	70	0,45	12	4	4	20	28
	150	0,75	20	2	2	12	17
	250	1,5	33	1	1	7	10
	400	2,1	35	1	1	5	7
	1000	5,8	95	-	-	2	3
	2000	11,5	148	-	-	1	1
400 V per pole	2000	6,5	58	-	-	1	2
	3500	11,6	100	-	-	-	1
Metal halide lamps with serial electronic (e.g. PCI) 50 - 125 x Inlamps for 0,6 ms	20	0,1	integrated	9	9	18	20
	35	0,2	integrated	6	6	11	13
	70	0,36	integrated	5	5	10	12
	150	0,7	integrated	4	4	8	10
Sodium-vapour lamps (low pressure lamps), uncompensated	35	1,5	-	7	9	22	30
	55	1,5	-	7	9	22	30
	90	2,4	-	4	6	13	19
	135	3,5	-	3	4	10	13
	150	3,3	-	3	4	10	13
	180	3,3	-	3	4	10	13
200	3,3	-	3	4	10	13	

Switching of Lamps

Lamp Type	Power [W]	Current [A]	Capacitors μ F	Max. lamps per pole at 230V 50Hz			
				R20	R25	R40	R63
Sodium-vapour lamps (low pressure lamps), compensated	35	0,31	20	3	3	12	16
	55	0,42	20	2	2	8	14
	90	0,63	30	1	1	5	9
	135	0,94	45	1	1	3	6
	150	1	40	1	1	3	6
	180	1,16	40	1	1	2	5
	200	1,32	25	-	-	2	4
Sodium-vapour lamps (high pressure lamps), uncompensated	150	1,8	-	5	6	11	22
	250	3	-	4	5	7	13
	330	3,7	-	3	4	6	10
	400	4,7	-	2	2	5	8
	1000	10,3	-	1	1	2	4
Sodium-vapour lamps (high pressure lamps), compensated	150	0,83	20	2	2	7	14
	250	1,5	33	1	1	4	8
	330	2	40	1	1	3	6
	400	2,4	48	1	1	2	5
	1000	6,3	106	-	-	1	2
Sodium-vapour lamps (high pressure lamps) with serial electronic (e.g. PCI) 50-125 x Inlamps for 0,6 ms	20	0,1	integrated	9	9	18	20
	35	0,2	integrated	6	6	11	13
	70	0,36	integrated	5	5	10	12
	150	0,7	integrated	4	4	8	10
LED Lamps	max. inrush current of contactor [A]			195	233	424	565

Modular contactors RD

Data according to IEC 947-4-1, IEC 947-5-1, VDE 0660, EN 60947-4-1, EN 60947-5-1

Type			RD20	RD25	RD40	RD63	
General	Standards	IEC/EN 61095, IEC/EN 60947-4-1, IEC/EN 60947-5-1					
	Module width		1	2	3		
	Mechanical endurance	op. c.	3 x 106		3 x 106		
	Ambient temperature	°C	-25 ... +70(2NO, 4NO) -15 ... +70 (1NO, 1NO+1NC, 3NO, 3NO+1NC) -15 ... +55 (2NC, 1NC, 2NO+2NC, 4NC)				
	Storage temperature	°C	-40 ... +80				
	No. of contactors (side-by-side)	≤ 40 °C		max. 3			
		40 - 55 °C		max. 2			
		55 - 70 °C		max. 1 (ventilation modules or least 9 mm free space on each side)			
	Contact reliability		17 V; ≥ 50 mA				
	Min. distance of open contacts	mm	3,6				
	Power dissipation per pole	W	1,7	2,2	4	8	
	Overload current withstand capability: 10s	A	72	68	176	240	
	Max. back-up fuse for short-circuit protection gL	I _v A	20	25	63	80	
	Coordination type 2						
	Noise level (operation)	dB	20	20	20	20	
	Vibration resistance according to IEC/EN 60068-2-6	a g	switched off: 2 (Z and X axis) / switched on: 3 (Z axis) and 1 (X axis)				
	Shock resistance according to IEC/EN 6068-2-27	a g	switched off: 10 (Z and X axis) / switched on: 15 (Z axis) and 2 (X axis)				
	Max. operating frequency	DC-1		300			
		AC-1/AC-3/AC-5b/AC-6b	op. c./h	600			
		AC-15		1200			
no load			3000				
Main circuit	Rated insulation voltage	U _i V	440		440		
	Rated impulse withstand voltage	U _{imp} kV	4				
	Thermal current	I _{th} A	20	25	40	63	
	Rated operational voltage	U _e V	400 ³⁾		400		
	Rated frequency	f Hz	50/60				
	Max. thermal current up to +55 °C	I _{th} A	20	25	40	63	
	Max. thermal current @ +70 °C	I _{th} A	16	20	40	50	
	Rated operational current	AC-1/AC-7a	I _e A	20	25	40	63
		AC-3/AC-7b	I _e A	9	8,5	22	30
		AC-5a	230 V I _e A	8,8	11,2	20	32
		AC-5b	230 V I _e A	8,8	9,7	17,6	22
		AC-6a	230 V I _e A	4	2,8	10,8	17,2
	Operational power AC-1/AC-7a	single-phase	230 V	3,7	5,4	8,7	13,3 ⁴⁾
		three-phase	230 V P _e kW	-	9	16	24
		three-phase	400 V	-	16	26	40
	Electrical endurance	AC-1 / AC-7a	op. c.	200.000		100.000	
		AC-3 / AC-7b	op. c.	300.000	500.000	150.000	
		AC-5a / AC-5b / AC-6a / AC-6b / AC-7c	op. c.	100.000			
	Operational power AC-3/AC-7b	single-phase motor	230 V	1,3 -> NO ¹⁾	1,3 ²⁾	3,7 ²⁾	5 ²⁾
		three-phase motor	230 V P _e kW	-	2,2	5,5	8,5
three-phase motor		400 V	-	4	11	15	
Switching of capacitors	AC-6b / AC-7c	230 V C μF	30	36	220	330	
Maximum operating frequency	AC-5a / AC-5b / AC-6a / AC-6b / AC-7c	op. c./h	600				

1) Make contacts are marked NO

2) Data for single-phase power are valid for versions -22, -20 and -02





3) Rated operational voltage for versions of contacts -10 and -01 is 230 V

4) Rated power (AC-1) for IK63-04: single-phase 230 V = 10.9 kW; three-phase 230 V = 18.9 kW; three-phase 400 V = 32.9 kW





Type				RD20	RD25	RD40	RD63		
Main circuit	Rated operational current	DC-1							
	1 pole	$U_e = 24\text{ V DC}$		20	25	40	63		
		$U_e = 110\text{ V DC}$	I_e	A	6	6	4	4	
		$U_e = 220\text{ V DC}$		0,6	0,6	1,2	1,2		
	2 poles connected in series	$U_e = 24\text{ V DC}$		20	25	40	63		
		$U_e = 110\text{ V DC}$	I_e	A	10	10	10	10	
		$U_e = 220\text{ V DC}$		6	6	8	8		
	3 poles connected in series	$U_e = 24\text{ V DC}$		-	25	40	63		
		$U_e = 110\text{ V DC}$	I_e	A	-	20	30	35	
		$U_e = 220\text{ V DC}$		-	15	20	30		
	4 poles connected in series	$U_e = 24\text{ V DC}$		-	25	40	63		
		$U_e = 110\text{ V DC}$	I_e	A	-	20	40	63	
		$U_e = 220\text{ V DC}$		-	15	40	63		
	Electrical endurance	DC-1		op. c.				100.000	
Maximum operating frequency	DC-1		op. c./h				300		
Terminal capacity	rigid	S	mm ²		1 ... 10	1.5 ... 25			
	flexible		1 ... 6	1.5 ... 16					
Screw			M3.5		M5				
Screw Head			PZ1		PZ2				
Tightening torque			1,2		3,5				
Auxiliary circuit	Rated operational voltage	U_e		V	230	400	400	400	
	Rated insulation voltage	U_i		V	230	440	440	440	
	Rated impulse withstand voltage	U_{imp}		kV	4				
	Thermal current	I_{th}		A	20	25	40	63	
	Rated operational current	single-phase	230 V	6					
	AC-15	single-phase	400 V	-					
	Electrical endurance	AC-15		op. c.		300.000	500.000	150.000	
Control circuit	Range of control voltage	U_c		%	85 ... 110				
	Control voltages	U_c		V	12 ... 230				
	Surge immunity test (1.2/50 μ s), acc. to IEC/EN 61000-4-5			kV	2				
	Coil consumption	switch-on operation			VA/W	2.1/2.1	2.6/2.6 5)	5/5	5/5
					2.1/2.1	2.6/2.6 5)	5/5	5/5	
	Make/break delays	make			ms	15 – 45	15 – 45	15 – 20	15 – 20
		break			20 – 50	20 – 70	35 – 45	35 – 45	
	Terminal capacity	rigid	S	mm ²		1 ... 2.5	1 ... 2.5		
		flexible		1 ... 2.5	1 ... 2.5				
	Screw			M 3.5		M3			
Screw head			PZ1						
Tightening torque			Nm					0,6	
Safety	MTTF - Mean time to failure			h	AC-1: 5.000	AC-1: 5.000	AC-1: 2.500		
				AC-3: 7.500	AC-3: 12.500	AC-3: 3.750			
	MTTFd - Mean time to failure dangerous			h	AC-1: 6.666	AC-1: 6.666	AC-1: 3.333		
				AC-3: 10.000	AC-3: 16.666	AC-3: 5.000			
	B10 - Number of operating cycles until 10 % of devices fail			op. c.	AC-1: 150.000	AC-1: 150.000	AC-1: 75.000		
			AC-3: 225.000	AC-3: 375.000	AC-3: 112.500				
	B10d - Number of operating cycles until 10 % of device dangerous			op. c.	AC-1: 200.000	AC-1: 200.000	AC-1: 100.000		
	B10d = B10/ratio of dangerous failures				AC-3: 300.000	AC-3: 500.000	AC-3: 150.000		
	λ - Failure rate			1/h	AC-1: 0,0002	AC-1: 0,0002	AC-1: 0,0004		
					AC-3: 0,000133	AC-3: 0,00008	AC-3: 0,000266		
λ_d - Failure rate dangerous			1/h	AC-1: 0,00015	AC-1: 0,00015	AC-1: 0,0003			
				AC-3: 0,0001	AC-3: 0,00006	AC-3: 0,0002			
Ratio of dangerous failures			%					75	
nop - Operating cycles (operating cycles/h)			op. c./h					300	

5) Coil consumption for version -04 is 3.8 VA/3.8 W

1-pole, 1 module (17,5 mm), 20 A (AC1, 230 V)

Type	Code No.	Wiring diagram		
RD 20-10-230V AC/DC	002464000		130	10
RD 20-10-24V AC/DC	002464001			
RD 20-01-230V AC/DC	002464002		130	10
RD 20-01-24V AC/DC	002464003			



2-pole, 1 module (17,5 mm), 20 A (AC1, 230 V)

Type	Code No.	Wiring diagram		
RD 20-20-230V AC/DC	002464004		130	10
RD 20-20-24V AC/DC	002464005			
RD 20-11-230V AC/DC	002464006		130	10
RD 20-11-24V AC/DC	002464007			
RD 20-02-230V AC/DC	002464008		130	10
RD 20-02-24V AC/DC	002464009			

Take care of dissipated heat by: $\leq 40^{\circ}\text{C}$ max. 3 modules side by side
 $40 - 55^{\circ}\text{C}$ max. 2 modules side by side.

For more contactors together, use distance piece IKV

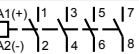
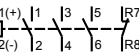
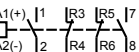
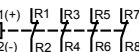

4-pole, 2 modules (35 mm), 25 A (AC1, 400 V)

Type	Code No.	Wiring diagram		
RD 25-40-230V AC/DC	002464010		240	5
RD 25-40-24V AC/DC	002464011			
RD 25-31-230V AC/DC	002464012		240	5
RD 25-31-24V AC/DC	002464013			
RD 25-22-230V AC/DC	002464014		240	5
RD 25-22-24V AC/DC	002464015			
RD 25-04-230V AC/DC	002464016		240	5
RD 25-04-24V AC/DC	002464017			



Take care of dissipated heat by: $\leq 40^{\circ}\text{C}$ max. 3 modules side by side
 $40 - 55^{\circ}\text{C}$ max. 2 modules side by side.

For more contactors together, use distance piece IKV



2-pole, 1 module (17,5 mm), 32 A (AC1, 230V)

Type	Code No.	Wiring diagram		
RD 32-20 230V AC/DC	002464077		130	10/80

4-pole, 2 modules (35 mm), 32 A (AC1, 400 V)

Type	Code No.	Wiring diagram		
RD 32-40 230V AC/DC	002464078		244	5/40

4-pole, 3 modules (52,5 mm), 40 A (AC1, 400 V)

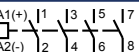
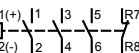
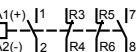
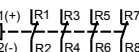
Type	Code No.	Wiring diagram		
RD 40-40-230V AC/DC	002464018		420	5
RD 40-40-24V AC/DC	002464019			
RD 40-31-230V AC/DC	002464020		420	5
RD 40-31-24V AC/DC	002464021			
RD 40-22-230V AC/DC	002464022		420	5
RD 40-22-24V AC/DC	002464023			
RD 40-04-230V AC/DC	002464024		420	5
RD 40-04-24V AC/DC	002464025			

Take care of dissipated heat by: $\leq 40^{\circ}\text{C}$ max. 3 modules side by side
 $40 - 55^{\circ}\text{C}$ max. 2 modules side by side.

For more contactors together, use distance piece IKV



4 pole, 3 modules (52,5mm), 63 A(AC1, 400 V)

Type	Code No.	Wiring diagram	g	
RD 63-40-230V AC/DC	002464026		420	5
RD 63-40-24V AC/DC	002464027			
RD 63-31-230V AC/DC	002464028			
RD 63-31-24V AC/DC	002464029			
RD 63-22-230V AC/DC	002464030			
RD 63-22-24V AC/DC	002464031			

Take care of dissipated heat by: $\leq 40^{\circ}\text{C}$ max. 3 modules side by side
 $40 - 55^{\circ}\text{C}$ max. 2 modules side by side.

For more contactors together, use distance piece IKV

Dimensions

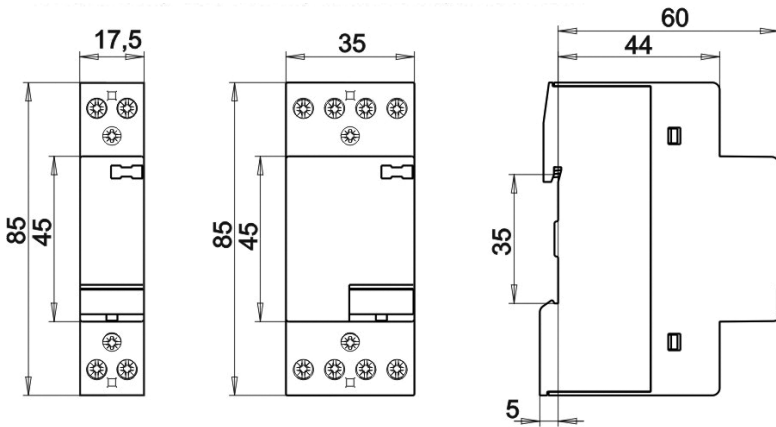

RD 20, RD 25,

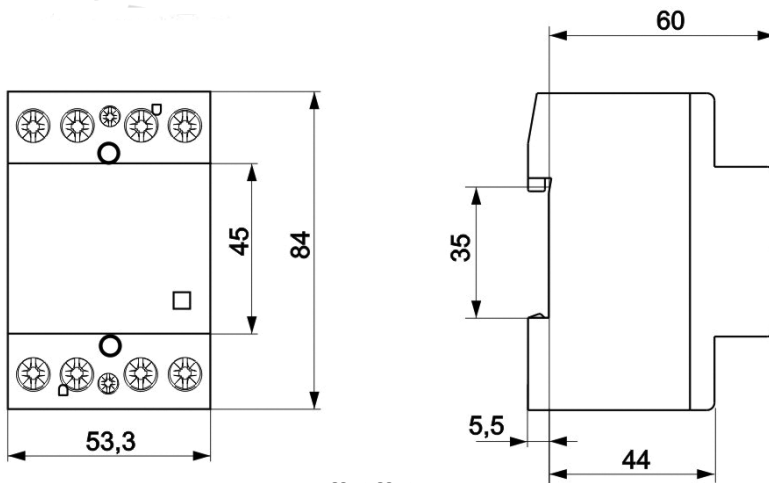

RD 40, RD 63

Modular contactors R...R, RD...R



Data according to IEC 947-4-1, IEC 947-5-1, VDE 0660, EN 60947-4-1, EN 60947-5-1

Type		R 20-R	RD 20-R	R 25-R	R D25-R				
General	Standards	IEC/EN 61095, IEC/EN 60947-4-1, IEC/EN 60947-5-1							
	Module width	1		2					
	Mechanical endurance	op. c. 3 x 106							
	Ambient temperature	°C -25 ... +70 (2NO, 4NO) -15 ... +70 (1NO, 1NO+1NC, 3NO, 3NO+1NC) -15 ... +55 (2NC, 1NC, 2NO+2NC, 4NC)							
	Storage temperature	°C -40 ... +80							
	No. of contactors (side-by-side)	≤ 40 °C	max. 3	max. 3	no limit	max. 3			
		40 - 55 °C	max. 2	max. 2		max. 2			
		55 - 70 °C	max. 1 (ventilation modules or least 9 mm free space on each side)						
	Contact reliability	17 V; ≥ 50 mA							
	Min. distance of open contacts	mm 3,6							
	Power dissipation per pole	W	1,7	1,7	2,2	2,2			
	Overload current withstand capability: 10s	A	72	72	68	68			
	Max. back-up fuse for short-circuit protection gL	I _v	A	20	20	25			
	Coordination type 2						A	20	25
	Noise level (operation)	dB 30 20 30 20							
	Vibration resistance according to IEC/EN 60068-2-6	a	g switched off: 2 (Z and X axis) / switched on: 3 (Z axis) and 1 (X axis)						
	Shock resistance according to IEC/EN 6068-2-27	a	g switched off: 10 (Z and X axis) / switched on: 15 (Z axis) and 2 (X axis)						
	Max. operating frequency	DC-1	op. c./h 300						
		AC-1/AC-3/AC-5b/AC-6b	600						
		AC-15	1200						
no load		3000							
Main circuit	Rated insulation voltage	U _i	V	440	440				
	Rated impulse withstand voltage	U _{imp}	kV	4					
	Thermal current	I _{th}	A	20	20	25	25		
	Rated operational voltage	U _e	V	400 ³⁾	400 ³⁾	400	400		
	Rated frequency	f	Hz	50/60					
	Max. thermal current up to +55 °C	I _{th}	A	20	20	25	25		
	Max. thermal current @ +70 °C	I _{th}	A	20	16	20	20		
	Rated operational current	AC-1/AC-7a	I _e	A	20	20	25	25	
									AC-3/AC-7b
		AC-5a	230 V	I _e	A	8,8	8,8	11,2	
						AC-5b	230 V	I _e	A
		AC-6a	230 V	I _e	A				
						Operational power AC-1/AC-7a	single-phase	230 V	
	three-phase	230 V	P _e	-	-		9	9	
	three-phase	400 V		-	-		16	16	
	Electrical endurance	AC-1/AC-7a	op. c.		200.000				
		AC-3/AC-7b	op. c.		300.000	500.000			
		AC-5a / AC-5b / AC-6a / AC-6b / AC-7c	op. c.		100.000				
	Operational power AC-3/AC-7b	single-phase motor	230 V	P _e	kW	1.3 -> NO ¹⁾	1.3 -> NO ¹⁾	1.3 ²⁾	1.3 ²⁾
		three-phase motor	230 V			-	-	2,2	2,2
three-phase motor		400 V	-			-	4	4	
Switching of capacitors	AC-6b	230 V	C	μF	30	30	36	36	
Maximum operating frequency	AC-5a / AC-5b / AC-6a / AC-6b / AC-7c		op. c./h		600				

1) Make contacts are marked NO
 2) Data for single-phase power are valid for versions -22, -20 and -02
 3) Rated operational voltage for versions of contacts -10 and -01 is 230 V
 4) Rated power (AC-1) for IK63-04: single-phase 230 V = 10.9 kW; three-phase 230 V = 18.9 kW; three-phase 400 V = 32.9 kW

Type				R 20-R	RD 20-R	R 25-R	RD 25-R	
Main circuit	Rated operational current	DC-1						
	1 pole	$U_e = 24\text{ V DC}$		20	20	25	25	
		$U_e = 110\text{ V DC}$	I_e	6				
		$U_e = 220\text{ V DC}$		0,6				
	2 poles connected in series	$U_e = 24\text{ V DC}$		20		25		
		$U_e = 110\text{ V DC}$	I_e	10				
		$U_e = 220\text{ V DC}$		6				
	3 poles connected in series	$U_e = 24\text{ V DC}$		-	-	25	25	
		$U_e = 110\text{ V DC}$	I_e	20				
		$U_e = 220\text{ V DC}$		15				
	4 poles connected in series	$U_e = 24\text{ V DC}$		-	-	25	25	
		$U_e = 110\text{ V DC}$	I_e	20				
$U_e = 220\text{ V DC}$		15						
Electrical endurance	DC-1		op. c.					
Maximum operating frequency	DC-1		op. c./h					
Terminal capacity	rigid		1 ... 10					
	flexible	S	1 ... 6					
Screw			M3.5					
Screw Head			PZ1					
Tightening torque			Nm					
			1,2					
Auxiliary circuit	Rated operational voltage	U_e		V	230	230	400	400
	Rated insulation voltage	U_i		V	230	230	440	440
	Rated impulse withstand voltage	U_{imp}		kV	4			
	Thermal current	I_{th}		A	20	20	25	25
	Rated operational current AC-15	single-phase	230 V					
		single-phase	400 V					
	Electrical endurance			op. c.		300.000	500.000	
Control circuit	Range of control voltage	U_c		%	85 ... 110			
	Control voltages	U_c		V	12 ... 230			
	Surge immunity test (1.2/50 μ s), acc. to IEC/EN 61000-4-5			kV	2			
	Coil consumption	switch-on (handle in A)						
		switch-on (handle in 1)		VA/W	12/10	2.1/2.1	33/25	2.6/2.6
		operation			6/3.8	2.1/2.1	10/5	2.6/2.6
	Make/break delays	make						
		break		ms	15 – 25	15 – 45	10 – 30	15 – 45
	Terminal capacity	rigid		mm ²				
		flexible		1 ... 2.5				
Screw			M3					
Screw head			PZ1					
Tightening torque			Nm					
			0,6					
Safety	MTTF - Mean time to failure			h		AC-1: 5.000	AC-3: 5.000	
	MTTF = $1/\lambda = B10/(0,1\ nop)$					AC-3: 7.500	AC-3: 12.500	
	MTTFd - Mean time to failure dangerous			h		AC-1: 6.666	AC-1: 6.666	
	MTTFd = $1/\lambda_d = B10d/(0,1\ nop)$					AC-3: 10.000	AC-3: 16.666	
	B10 - Number of operating cycles until 10 % of devices fail			op. c.		AC-1: 150.000 / AC-3: 225.000		
	B10d - Number of operating cycles until 10 % of device dangerous			op. c.		AC-1: 200.000		
	B10d = B10/ratio of dangerous failures					AC-3: 300.000		
	λ - Failure rate			1/h		AC-1: 0,0002		
	$\lambda = (0,1\ nop)/B10$					AC-3: 0,000133		
	λ_d - Failure rate dangerous			1/h		AC-1: 0,00015		
$\lambda_d = (0,1\ nop)/B10d$					AC-3: 0,0001			
Ratio of dangerous failures			%		75			
nop - Operating cycles (operating cycles/h)			op. c./h		300			

1-pole, ON - OFF - AUTO, 1 module (17,5 mm), 20 A (AC1, 230V)

Type	Code No.	Wiring diagram		
R 20-10-R-230V AC	002464032		130	10
R 20-10-R-24V AC	002464033			
RD 20-10-R-230V AC/DC	002464034			
RD 20-10-R-24V AC/DC	002464035		130	10
R 20-01-R-230V AC	002464036			
R 20-01-R-24V AC	002464037			
RD 20-01-R-230V AC/DC	002464038		130	10
RD 20-01-R-24V AC/DC	002464039			



2-pole, ON - OFF - AUTO, 1 module (17,5 mm), 20 A (AC1, 230V)

R 20-20-R-230V AC	002464040		130	10
R 20-20-R-24V AC	002464041			
RD 20-20-R-230V AC/DC	002464042			
RD 20-20-R-24V AC/DC	002464043		130	10
R 20-11-R-230V AC	002464044			
R 20-11-R-24V AC	002464045			
RD 20-11-R-230V AC/DC	002464046		130	10
RD 20-11-R-24V AC/DC	002464047			
R 20-02-R-230V AC	002464048		130	10
R 20-02-R-24V AC	002464049			
RD 20-02-R-230V AC/DC	002464050		130	10
RD 20-02-R-24V AC/DC	002464051			

Take care of dissipated heat by: $\leq 40^\circ\text{C}$ max. 3 modules side by side
 $40 - 55^\circ\text{C}$ max. 2 modules side by side.

For more contactors together, use distance piece IKV

**4-pole, ON - OFF - AUTO, 2 modules (35 mm), 25 A (AC1, 400 V)**

Type	Code No.	Wiring diagram		
R 25-40-R-230V AC	002464052		240	5
R 25-40-R-24V AC	002464053			
RD 25-40-R-230V AC/DC	002464054			
RD 25-40-R-24V AC/DC	002464055		240	5
R 25-31-R-230V AC	002464056			
R 25-31-R-24V AC	002464057			
RD 25-31-R-230V AC/DC	002464058		240	5
RD 25-31-R-24V AC/DC	002464059			
R 25-22-R-230V AC	002464060		240	5
R 25-22-R-24V AC	002464061			
RD 25-22-R-230V AC/DC	002464062		240	5
RD 25-22-R-24V AC/DC	002464063			
R 25-04-R-230V AC	002464064		240	5
R 25-04-R-24V AC	002464065			
RD 25-04-R-230V AC/DC	002464066		240	5
RD 25-04-R-24V AC/DC	002464067			

Take care of dissipated heat by: $\leq 40^\circ\text{C}$ max. 3 modules side by side
 $40 - 55^\circ\text{C}$ max. 2 modules side by side.

For more contactors together, use distance piece IKV



Dimensions

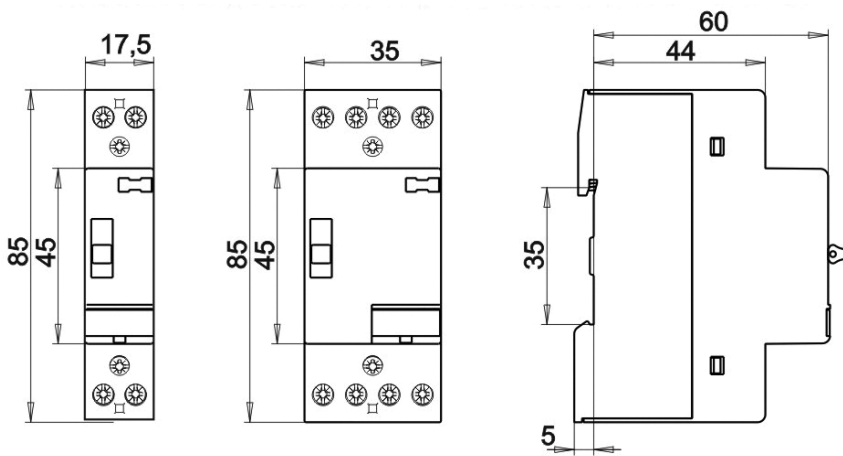

RD 20 - R, RD 25 - R

Mounting position

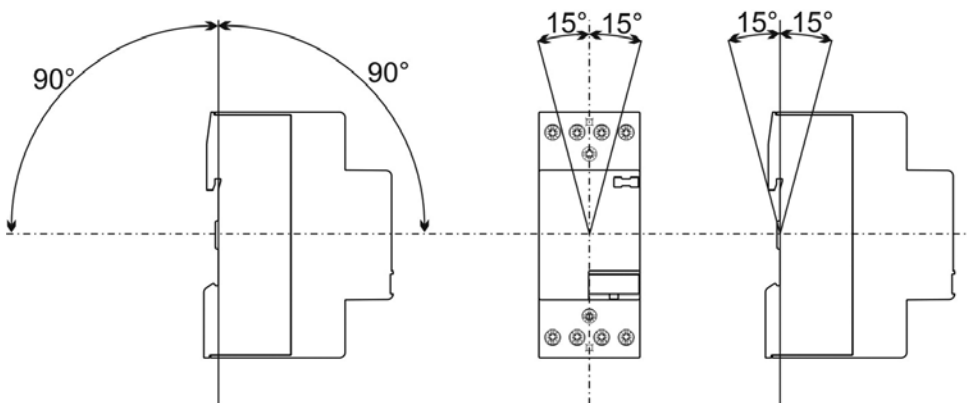





Accessories

Technical data

Type				RN	
Standards				IEC/EN 60947-5-1	
Module width				1/2	
Rated insulation voltage U_i		U_i	V	500	
Rated impulse withstand voltage U_{imp}		U_{imp}	kV	4	
Thermal current		I_{th}	A	6	
Rated operational voltage		U_e	V	230	
				400	
Rated operational current	AC-15	$U_e = 230\text{ V}$	I_e	A	6
		$U_e = 400\text{ V}$			4
Electrical endurance				op. c.	50.000
Mechanical endurance				op. c.	3 x 106
Min. distance of open contacts				mm	4
Contact reliability					12 V; $\geq 5\text{ mA}$
Power loss per pole				W	0,3
Weight				kg	0,035
Max. back-up fuse for short-circuit protection gL					
Coordination type 2			I_v	A	6
Terminal capacity	rigid	S		mm ²	1...2,5
	flexible				1...2,5
Screw					M3
Screw head					PZ1
Tightening torque				Nm	0,6

Auxiliary contactor block for contactors RD, R...R, RD...R

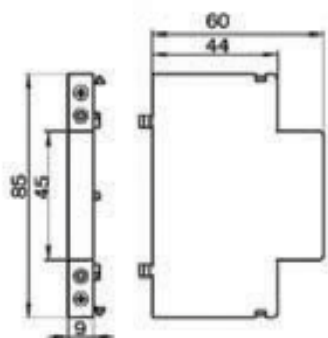
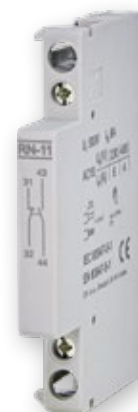

Type	Code No.	Wiring diagram	 g	
RN-20	002464068		30	1
RN-02	002464069		30	1
RN-11	002464070		30	1

* The auxiliary switch should not be applied in combination with RD20 and RD20-R.

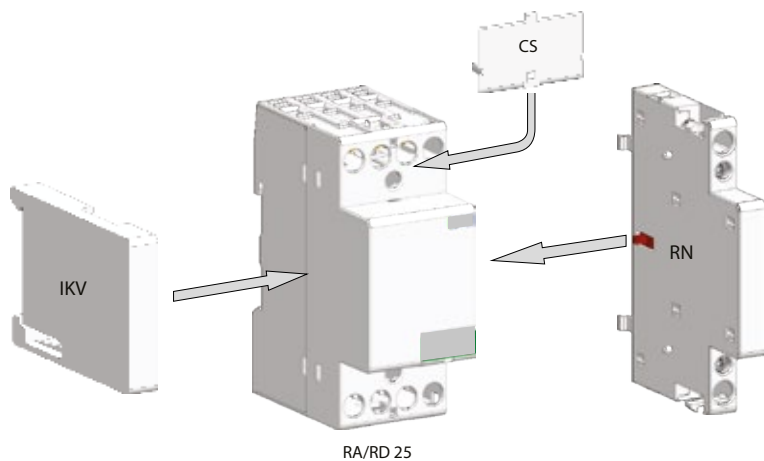



Sealing cover

Type	Code No.	For use with		
SC20	002464071	RD 20, R20...R	3	2
SC25	002464072	RD 25, R25...R	4	2
SC40/63	002464073	RD 40, RD 60	5	2



Distance piece

Type	Code No.	For use with		
IKV	002464074	RD, R...R	6	1



LED lamps, Power supplies for LEDs

Max. lamps per pole at 230V 50Hz			
RD20, RD20-R, R20-R	RD25, RD25-R, R25-R	RD40	RD63
max. 2,4 A per pole	max. 3,8 A per pole	max. 11 A per pole	max. 18 A per pole

Type	Power (W)	Current (A)	C (µF)	Max. number of lamps per pole at 230 V 50 Hz			
				RD20	RD25	RD40	RD63
Incandescent lamps (tungsten filament)	60	0,26	—	33	33	65	85
	100	0,44	—	20	20	40	50
	200	0,87	—	10	10	20	25
	500	2,17	—	3	3	8	10
	1000	4,35	—	1	1	4	5
Fluorescent lamps. uncorrected or series correction	18	0,37	2,7	22	24	90	140
	24	0,35	2,5	22	24	90	140
	36	0,43	3,4	17	20	65	95
	58	0,67	5,3	14	17	45	70
Fluorescent lamps. lead-lag circuit	2 x 18	0,11	—	2 x 30	2 x 40	2 x 100	2 x 150
	2 x 24	0,14	—	2 x 24	2 x 31	2 x 78	2 x 118
	2 x 36	0,22	—	2 x 17	2 x 24	2 x 65	2 x 95
	2 x 58	0,35	—	2 x 10	2 x 14	2 x 40	2 x 60
Fluorescent lamps. parallel correction	18	0,12	4,5	7	8	48	73
	24	0,15	4,5	7	8	48	73
	36	0,00	4,5	7	8	48	73
	58	0,32	7	4	5	31	47
Fluorescent lamps with electronic ballast units (EVG)	18	0,09	—	25	35	100	140
	36	0,16	—	15	20	52	75
	58	0,25	—	14	19	50	72
	2 x 18	0,17	—	2 x 12	2 x 17	2 x 50	2 x 70
	2 x 36	0,32	—	2 x 7	2 x 10	2 x 26	2 x 38
	2 x 58	0,49	—	2 x 7	2 x 9	2 x 25	2 x 36
High-pressure mercury-vapour lamps. uncorrected	50	0,61	—	14	18	38	55
	80	0,01	—	10	13	29	42
	125	1,15	—	7	9	20	29
	250	2,15	—	4	5	10	15
	400	3,25	—	2	3	7	10
	700	0,05	—	1	2	4	6
High-pressure mercury- vapour lamps. parallel correction	1000	0,08	—	1	1	3	4
	50	0,28	7	4	5	31	47
	80	0,41	8	4	5	27	41
	125	0,65	10	3	4	22	33
	250	1,22	18	1	2	12	18
	400	1,95	25	1	1	9	13
	700	3,45	45	—	—	5	7
Halogen metal-vapour lamps. uncorrected	1000	0,05	60	—	—	4	5
	35	0,53	—	18	22	43	60
	70	0,01	—	10	12	23	32
	150	0,02	—	5	7	12	18
	250	0,03	—	3	4	7	10
	400	0,04	—	3	3	6	9
	1000	0,10	—	1	1	2	3
Halogen metal-vapour lamps, parallel correction	2000	16,5	—	—	—	1	1
	35	0,25	6	5	6	36	50
	70	0,45	12	2	3	18	25
	150	0,75	20	1	1	11	15
	250	0,02	33	—	1	6	9
	400	0,03	35	—	1	6	8
	1000	0,06	95	—	—	2	3
Halogen metal-vapour lamps with electronic ballast unit PCI 50-125 x ln lamp for 0.6 ms	2000	0,12	148	—	—	1	2
	20	0,00	integrated	9	9	18	20
	35	0,00	integrated	6	6	11	13
	70	0,36	integrated	5	5	10	12
	150	0,01	integrated	4	4	8	10

Type	Power (W)	Current (A)	C (µF)	Max. number of lamps per pole at 230 V 50 Hz				
				RD20	RD25	RD40	RD63	
Transformers for halogen metal-vapour lamps	20	—	—	40	52	110	174	
	50	—	—	20	24	50	80	
	75	—	—	13	16	35	54	
	100	—	—	10	12	27	43	
	150	—	—	7	9	19	29	
	200	—	—	5	6	14	23	
	300	—	—	3	4	9	14	
High-pressure sodium-vapour lamps. uncorrected	150	002	—	5	6	17	22	
	250	003	—	3	4	10	13	
	400	005	—	2	2	6	8	
	1000	10,3	—	—	1	3	3	
High-pressure sodium-vapour lamps. parallel correction	150	0,83	20	1	1	11	16	
	250	002	33	—	1	6	10	
	400	002	48	—	—	4	6	
	1000	006	106	—	—	2	3	
Halogen metal-vapour lamps with electronic ballast unit PCI 50-125 x ln lamp for 0.6 ms	20	000	integrated	9	9	18	20	
	35	000	integrated	6	6	11	13	
	70	0,36	integrated	5	5	10	12	
	150	001	integrated	4	4	8	10	
Low-pressure sodium-vapour lamps. uncorrected	18	0,35	—	22	27	71	90	
	35	002	—	7	9	23	30	
	55	002	—	7	9	23	30	
	90	002	—	4	5	14	19	
	135	004	—	3	4	10	13	
	180	003	—	3	4	10	13	
Low-pressure sodium-vapour lamps. parallel correction	18	0,35	5	6	7	44	66	
	35	0,31	20	1	1	11	16	
	55	0,42	20	1	1	11	16	
	90	0,63	26	1	1	8	12	
	135	0,94	45	—	—	5	8	
	180	1,16	40	—	—	4	7	
Fluorescent lamps LUMILUX T5 with electronic ballast unit (EVG)	22	0,11	FC	22	30	80	110	
	40	0,21		12	15	40	60	
	55	0,28		8	12	30	45	
	14	0,08	HE	30	40	105	150	
	21	0,11		22	30	80	115	
	28	0,14		18	22	60	90	
	35	0,18		14	18	48	70	
	24	0,12		20	26	70	100	
	39	0,20	HO	12	16	42	62	
	49	0,24		10	14	35	52	
	54	0,27		9	13	32	47	
	80	0,39		6	8	22	32	
	2 x 22	0,23		2 x FC	2 x 11	2 x 15	2 x 40	2 x 55
	2 x 40	0,42			2 x 6	2 x 7	2 x 20	2 x 30
	2 x 55	0,55			2 x 4	2 x 6	2 x 15	2 x 22
	2 x 14	0,15			2 x 15	2 x 20	2 x 52	2 x 75
	2 x 21	0,22	2 x HE	2 x 11	2 x 15	2 x 40	2 x 57	
	2 x 28	0,28		2 x 9	2 x 11	2 x 20	2 x 45	
	2 x 35	0,36		2 x 7	2 x 9	2 x 24	2 x 35	
	2 x 24	0,24		2 x 10	2 x 13	2 x 35	2 x 50	
	2 x 39	0,39	2 x HO	2 x 6	2 x 8	2 x 21	2 x 31	
	2 x 49	0,48		2 x 5	2 x 7	2 x 17	2 x 26	
	2 x 54	0,54		2 x 4	2 x 6	2 x 16	2 x 23	
	2 x 80	0,74		2 x 3	2 x 4	2 x 11	2 x 16	

Type	Power (W)	Current (A)	C (µF)	Max. number of lamps per pole at 230 V 50 Hz			
				R20-R	RD20-R	R25-R	RD25-R
Incandescent lamp (tungsten filament)	60	0,26	—	33	33	33	33
	100	0,44	—	20	20	20	20
	200	0,87	—	10	10	10	10
	500	2,17	—	3	3	3	3
	1000	4,35	—	1	1	1	1
Fluorescent lamps uncorrected or series correction	18	0,37	2,7	22	22	24	24
	24	0,35	2,5	22	22	24	24
	36	0,43	3,4	17	17	20	20
Fluorescent lamps lead-lag circuit	58	0,67	5,3	14	14	17	17
	2 x 18	0,11	—	2 x 30	2 x 30	2 x 40	2 x 40
	2 x 24	0,14	—	2 x 24	2 x 24	2 x 31	2 x 31
	2 x 36	0,22	—	2 x 17	2 x 17	2 x 24	2 x 24
Fluorescent lamps parallel correction	2 x 58	0,35	—	2 x 10	2 x 10	2 x 14	2 x 14
	18	0,12	4,5	7	7	8	8
	24	0,15	4,5	7	7	8	8
	36	0,20	4,5	7	7	8	8
Fluorescent lamps with electronic ballast units (EVG)	58	0,32	7	4	4	5	5
	18	0,09	—	25	25	35	35
	36	0,16	—	15	15	20	20
	58	0,25	—	14	14	19	19
	2 x 18	0,17	—	2 x 12	2 x 12	2 x 17	2 x 17
	2 x 36	0,32	—	2 x 7	2 x 7	2 x 10	2 x 10
High-pressure mercury-vapour lamps uncorrected	2 x 58	0,49	—	2 x 7	2 x 7	2 x 9	2 x 9
	50	0,61	—	14	14	18	18
	80	0,01	—	10	10	13	13
	125	1,15	—	7	7	9	9
	250	2,15	—	4	4	5	5
	400	3,25	—	2	2	3	3
	700	0,05	—	1	1	2	2
	1000	0,08	—	1	1	1	1
High-pressure mercury-vapour lamps. parallel correction	50	0,28	7	4	4	5	5
	80	0,41	8	4	4	5	5
	125	0,65	10	3	3	4	4
	250	1,22	18	1	1	2	2
	400	1,95	25	1	1	1	1
	700	3,45	45	—	—	—	—
	1000	0,05	60	—	—	—	—
Halogen metal-vapour lamps uncorrected	35	0,53	—	18	18	22	22
	70	0,01	—	10	10	12	12
	150	0,02	—	5	5	7	7
	250	0,03	—	3	3	4	4
	1000	0,10	—	1	1	1	1
	2000	16,5	—	—	—	—	—
Halogen metal-vapour lamps, parallel correction	35	0,25	6	5	5	6	6
	70	0,45	12	2	2	3	3
	150	0,75	20	1	1	1	1
	250	0,02	33	—	—	1	1
	400	0,03	35	—	—	1	1
	1000	0,06	95	—	—	—	—
	2000	11,5	148	—	—	—	—
Halogen metal-vapour lamps with electronic ballast unit PCI 50-125 x In lamp for 0.6 ms	20	0,00	integrated	9	9	9	9
	35	0,00	integrated	6	6	6	6
	70	0,36	integrated	5	5	5	5
	150	0,01	integrated	4	4	4	4

Type	Power (W)	Current (A)	C (µF)	Max. number of lamps per pole at 230 V 50 Hz				
				R20-R	RD20-R	R25-R	RD25-R	
Transformers for halogen metal-vapour lamps	20	—	—	40	40	52	52	
	50	—	—	20	20	24	24	
	75	—	—	13	13	16	16	
	100	—	—	10	10	12	12	
	150	—	—	7	7	9	9	
	200	—	—	5	5	6	6	
	300	—	—	3	3	4	4	
High-pressure sodium-vapour lamps, uncorrected	150	002	—	5	5	6	6	
	250	003	—	3	3	4	4	
	400	005	—	2	2	2	2	
	1000	10,3	—	—	—	1	1	
High-pressure sodium-vapour lamps, parallel correction	150	0,83	20	1	1	1	1	
	250	002	33	—	—	1	1	
	400	002	48	—	—	—	—	
	1000	006	106	—	—	—	—	
Halogen metal-vapour lamps with electronic ballast unit PCI 50-125 x ln lamp for 0.6 ms	20	000	integrated	9	9	9	9	
	35	000	integrated	6	6	6	6	
	70	0,36	integrated	5	5	5	5	
	150	001	integrated	4	4	4	4	
Low-pressure sodium-vapour lamps, uncorrected	18	0,35	—	22	22	27	27	
	35	002	—	7	7	9	9	
	55	002	—	7	7	9	9	
	90	002	—	4	4	5	5	
	135	004	—	3	3	4	4	
	180	003	—	3	3	4	4	
Low-pressure sodium-vapour lamps, parallel correction	18	0,35	5	6	6	7	7	
	35	0,31	20	1	1	1	1	
	55	0,42	20	1	1	1	1	
	90	0,63	26	1	1	1	1	
	135	0,94	45	—	—	—	—	
	180	1,16	40	—	—	—	—	
Fluorescent lamps LUMILUX T5 with electronic ballast unit (EVG)	22	0,11	FC	22	22	30	30	
	40	0,21		12	12	15	15	
	55	0,28		8	8	12	12	
	14	0,08	HE	30	30	40	40	
	21	0,11		22	22	30	30	
	28	0,14		18	18	22	22	
	35	0,18		14	14	18	18	
	24	0,12		20	20	26	26	
	39	000	HO	12	12	16	16	
	49	0,24		10	10	14	14	
	54	0,27		9	9	13	13	
	80	0,39		6	6	8	8	
	2 x 22	0,23		2 x FC	2 x 11	2 x 11	2 x 15	2 x 15
	2 x 40	0,42			2 x 6	2 x 6	2 x 7	2 x 7
	2 x 55	0,55	2 x 4		2 x 4	2 x 6	2 x 6	
	2 x 14	0,15	2 x HE	2 x 15	2 x 15	2 x 20	2 x 20	
	2 x 21	0,22		2 x 11	2 x 11	2 x 15	2 x 15	
	2 x 28	0,28		2 x 9	2 x 9	2 x 11	2 x 11	
	2 x 35	0,36		2 x 7	2 x 7	2 x 9	2 x 9	
	2 x 24	0,24		2 x 10	2 x 10	2 x 13	2 x 13	
	2 x 39	0,39		2 x 6	2 x 6	2 x 8	2 x 8	
	2 x 49	0,48	2 x HO	2 x 5	2 x 5	2 x 7	2 x 7	
2 x 54	0,54	2 x 4		2 x 4	2 x 6	2 x 6		
2 x 80	0,74	2 x 3		2 x 3	2 x 4	2 x 4		

ETICON



Bistable switches RBS

Technical data



Type			RBS220	RBS225	RBS232	RBS420	RBS425	BI432
Standards			IEC/EN 60669-2-2					
Manual control			✓					
Control with impulse voltage			✓					
Indication			With actuator					
Protection degree accordance to IEC/EN 60529			IP 20					
Module width			1			2		
Ambient temperature		°C	-25...+55					
Storage temperature		°C	-30...+80					
Max. resistance to humidity			95 % RH @ +55 °C					
Min. contact reliability			10 V / 100 mA					
Max. shock resistance accordance to IEC/EN 60068-2-27		g	15					
Max. vibration resistance accordance to IEC/EN 60068-2-6		g	3					
Min. distance of open contacts		mm	>3					
Distance between contacts and coil		mm	>6					
Mechanical endurance		cycles	106					
Max. back-up fuse for short-circuit protection (gL)		A	20	25	32	20	25	32
Power dissipation per pole		W	1,5	2	3	1,5	2	3
Rated control voltages	U_c	V	AC: 24, 230, other on request					
Rated frequency of control voltage	f_c	Hz	50 / 60					
Range of control voltage	U_c	%	90...110					
Coil consumption – inrush		VA/W	18 / 13					
Coil consumption – hold		VA/W	9 / 4					
Min. impulse duration at U_c		ms	50					
Min. impulse duration at 0,85 U_c		ms	100					
Min. duration between two impulses		ms	150					
Max. number of impulses per minute			15	7,5	15	15	7,5	7,5
Max. impulse duration at U_c		h	1					
Rated impulse voltage	U_{imp}	kV	4					
Thermal current	I_{th}	A	20	25	32	20	25	32
Rated insulation voltage	U_i	V	440					
Rated operational voltage	U_e	V	440					
Rated frequency	f_e	Hz	50 / 60					
Rated operational current for $\cos\phi = 0,6$ acc. to IEC/EN 60669-2-2	I_e	A	20 / 440 V	25 / 440 V	32 / 440 V	20 / 440 V	25 / 440 V	32 / 440 V
Rated operational current for AC-1 acc. to IEC/EN 60947-4-1	I_e	A	20 / 440 V	25 / 440 V	32 / 440 V	20 / 440 V	25 / 440 V	32 / 440 V
Rated operational current for AC-7a acc. to IEC/EN 61095 – Slightly inductive loads in household appliances and similar applications	I_e	A	20 / 440 V	25 / 440 V	32 / 440 V	20 / 440 V	25 / 440 V	32 / 440 V
Rated operational current for AC-21 acc. to IEC/EN 60947-3 – Switching of resistive loads including moderate overloads	I_e	A	20 / 440 V	25 / 440 V	32 / 440 V	20 / 440 V	25 / 440 V	32 / 440 V
Rated operational current for AC-22 acc. to IEC/EN 60947-3			20 / 230 V	25 / 230 V	32 / 230 V	20 / 230 V	25 / 230 V	32 / 230 V
Switching of mixed resistive and inductive loads, including moderate overloads	I_e	A	16 / 440 V	20 / 440 V	25 / 440 V	16 / 440 V	20 / 440 V	25 / 440 V
Rated operational current for AC-23 acc. to IEC/EN 60947-3 Switching of motor loads or other highly inductive loads	I_e	A	16 / 230 V / 1-phase	20 / 230 V / 1-phase	25 / 230 V / 1-phase	16 / 230 V / 3-phase	20 / 230 V / 3-phase	25 / 230 V / 3-phase
						16 / 400 V / 3-phase	20 / 400 V / 3-phase	25 / 400 V / 3-phase

<p>Description</p> <p>REMOTE SWITCHING AND AUTOMATIC CONTROL:</p> <ul style="list-style-type: none"> /// Lightning /// Electric heating /// Electric motors /// Electric equipment 	<p>ADVANCED OPERATION:</p> <ul style="list-style-type: none"> /// Impulse control /// Manual control <p>OTHER BENEFITS:</p> <ul style="list-style-type: none"> /// Small switch on coil consumption /// No hold coil consumption /// Wide application /// Mounting on 35 mm rail /// Sealing terminal covers
--	---

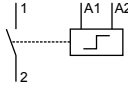
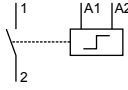
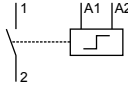

1-pole, 1 module (17,5 mm), 20A (AC1, 440V)

Type	Code No.	Wiring diagram	 g	
RBS220-10-230V AC	002464100		130	8
RBS220-10-24V AC	002464112		130	8
RBS220-10-12V AC	002464162		130	8

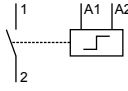
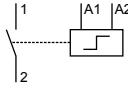

1-pole, 1 module (17,5 mm), 25A (AC1, 440V)

Type	Code No.	Wiring diagram	 g	
RBS225-10-230V AC	002464101		130	8
RBS225-10-24V AC	002464113		130	8

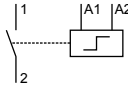
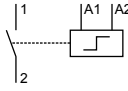
1-pole, 1 module (17,5 mm), 32A (AC1, 440V)

Type	Code No.	Wiring diagram	 g	
RBS232-10-230V AC	002464102		130	8
RBS232-10-24V AC	002464114		130	8



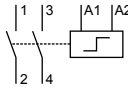
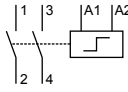
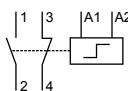
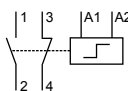
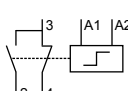
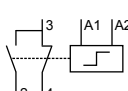

2-pole, 1 module (17,5 mm), 20A (AC1, 440V)

Type	Code No.	Wiring diagram	 g	
RBS220-20-230V AC	002464103		130	8
RBS220-20-24V AC	002464115		130	8
RBS220-11-230V AC	002464106		130	8
RBS220-11-24V AC	002464118		130	8
RBS220-1C-230V AC	002464109		130	8
RBS220-1C-24V AC	002464121		130	8





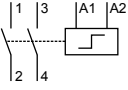
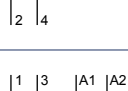
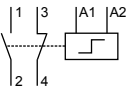

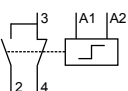
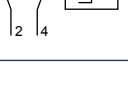
ETICON / Bistable switches RBS



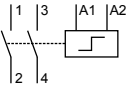
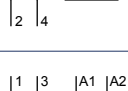
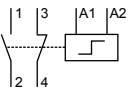

2-pole, 1 module (17,5 mm), 25A (AC1, 440V)

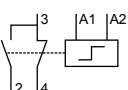
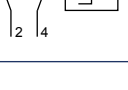
Type	Code No.	Wiring diagram		
RBS225-20-230V AC	002464104		130	8
RBS225-20-24V AC	002464116		130	8
RBS225-11-230V AC	002464107		130	8
RBS225-11-24V AC	002464119		130	8
RBS225-1C-230V AC	002464110		130	8
RBS225-1C-24V AC	002464122		130	8

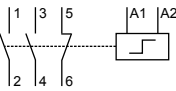

2-pole, 1 module (17,5 mm), 32A (AC1, 440V)

Type	Code No.	Wiring diagram		
RBS232-20-230V AC	002464105		130	8
RBS232-20-24V AC	002464117		130	8
RBS232-11-230V AC	002464108		130	8
RBS232-11-24V AC	002464120		130	8
RBS232-1C-230V AC	002464111		130	8
RBS232-1C-24V AC	002464123		130	8

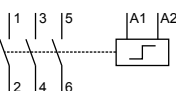
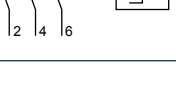
3-pole, 2 modules (35 mm), 20A (AC1, 440V)

Type	Code No.	Wiring diagram		
RBS420-21-230V AC	002464127		200	4
RBS420-21-24V AC	002464145		200	4
RBS420-30-230V AC	002464130		200	4
RBS420-30-24V AC	002464148		200	4

3-pole, 2 modules (35 mm), 25A (AC1, 440V)

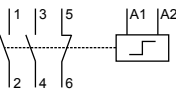
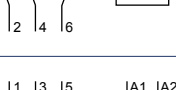
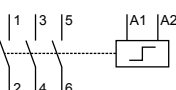
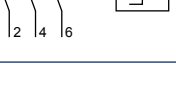
Type	Code No.	Wiring diagram		
RBS425-21-230V AC	002464128		200	4
RBS425-21-24V AC	002464146		200	4
RBS425-30-230V AC	002464131		200	4
RBS425-30-24V AC	002464149		200	4

3-pole, 2 modules (35 mm), 32A (AC1, 440V)

Type	Code No.	Wiring diagram	g	Box
RBS432-21-230V AC	002464129		200	4
RBS432-21-24V AC	002464147		200	4
RBS432-30-230V AC	002464132		200	4
RBS432-30-24V AC	002464150		200	4



4-pole, 2 modules (35 mm), 20A (AC1, 440V)



Type	Code No.	Wiring diagram	g	Box
RBS420-40-230V AC	002464124		200	4
RBS420-40-24V AC	002464142		200	4
RBS420-31-230V AC	002464133		200	4
RBS420-31-24V AC	002464151		200	4
RBS420-22-230V AC	002464136		200	4
RBS420-22-24V AC	002464154		200	4
RBS420-2C-230V AC	002464139		200	4
RBS420-2C-24V AC	002464157		200	4

4-pole, 2 modules (35 mm), 25A (AC1, 440V)

Type	Code No.	Wiring diagram	g	Box
RBS425-40-230V AC	002464125		200	4
RBS425-40-24V AC	002464143		200	4
RBS425-31-230V AC	002464134		200	4
RBS425-31-24V AC	002464152		200	4
RBS425-22-230V AC	002464137		200	4
RBS425-22-24V AC	002464155		200	4
RBS425-2C-230V AC	002464140		200	4
RBS425-2C-24V AC	002464158		200	4

ETICON / Bistable switches RBS

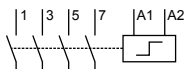
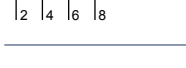
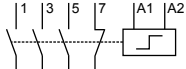
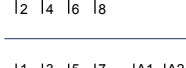
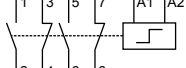
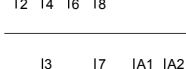
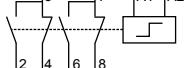
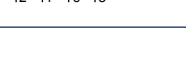

4-pole, 2 modules (35 mm), 32A (AC1, 440V)

Type	Code No.	Wiring diagram	 g	
RBS432-40-230V AC	002464126		200	4
RBS432-40-24V AC	002464144		200	4
RBS432-31-230V AC	002464135		200	4
RBS432-31-24V AC	002464153		200	4
RBS432-22-230V AC	002464138		200	4
RBS432-22-24V AC	002464156		200	4
RBS432-2C-230V AC	002464141		200	4
RBS432-2C-24V AC	002464159		200	4

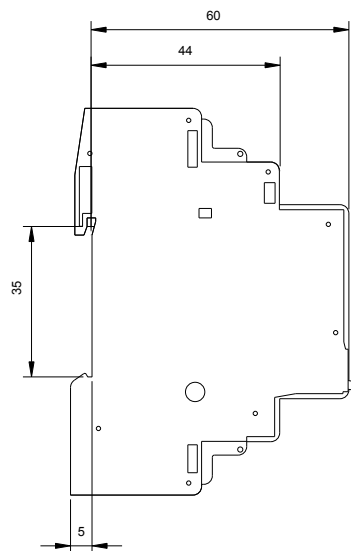
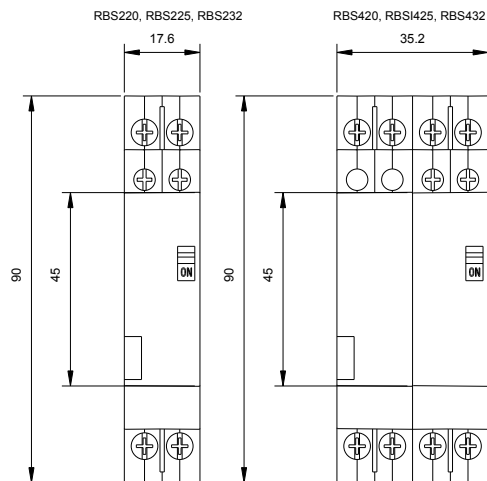
Dimensions



Sealing cover

Type	Code No.	 g	
SC	002464160	3	2

*Size of one module - for covering 2-module sized RBS two pcs are needed, one for each side

Mounting position

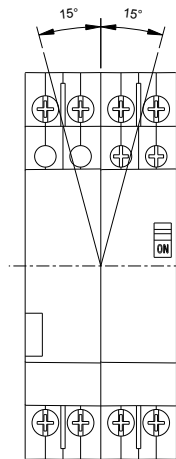
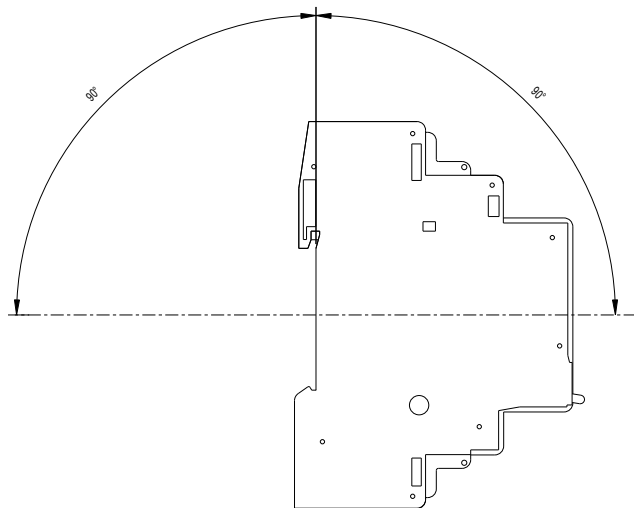

Technical data

Type		RBS220	RBS225	RBS232	RBS420	RBS425	BI432	
Rated operational current for AC-3 acc. to IEC/EN 60947-4-1 Squirrel-cage motors: starting, switching off motors during running	I_e	A	7 / 230 V / 1-phase	8 / 230 V / 1-phase	10 / 230 V / 1-phase	7 / 230 V / 1-phase	10 / 230 V / 1-phase	
						6,3 / 230 V / 3-phase	8,7 V / 230 V / 3-phase	11,5 / 230 V / 3-phase
						6,6 / 400 V / 3-phase	8,5 / 400 V / 3-phase	11,3 / 400 V / 3-phase
Rated operational current for AC-7b acc. to IEC/EN 61095 Motor- loads for household applications	I_e	A	7 / 230 V / 1-phase	8 / 230 V / 1-phase	10 / 230 V / 1-phase	7 / 230 V / 1-phase	10 / 230 V / 1-phase	
						6,3 / 230 V / 3-phase	8,7 V / 230 V / 3-phase	11,5 / 230 V / 3-phase
						6,6 / 400 V / 3-phase	8,5 / 400 V / 3-phase	11,3 / 400 V / 3-phase
Rated operational current for AC-6a acc. to IEC/EN 60947-4-1 Switching of transformers having inrush current peaks of not more than 30 times peak of rated current	I_e	A	3 / 230 V	3,6 / 230 V	4,5 / 230 V	3 / 230 V	3,6 / 230 V	
			1,5 / 400 V	1,8 / 400 V	2,2 / 400 V	1,5 / 400 V	1,8 / 400 V	2,2 / 400 V
Rated operational current for AC-6b acc. to IEC/EN 60947-4-1 – Switching of capacitor banks	C	μ F	100 μ F / 230 V					
Rated operational current for DC-1 acc. to IEC/EN 60947-4-1 – Non-inductive or slightly inductive loads, resistance furnances	I_e	A	20 / 24 V / 1p	25 / 24 V / 1p	32 / 24 V / 1p	20 / 24 V / 1p	25 / 24 V / 1p	
Rated operational current for DC-3 acc. to IEC/EN 60947-4-1 – Shunt-motors: starting, plugging, inching	I_e	A	10 / 24 V / 1p	15 / 24 V / 1p	25 / 24 V / 1p	10 / 24 V / 1p	15 / 24 V / 1p	
Rated operational current for DC-5 acc. to IEC/EN 60947-4-1 – Series-motors: starting, plugging, inching	I_e	A	10 / 24 V / 1p	16 / 24 V / 1p	20 / 24 V / 1p	10 / 24 V / 1p	16 / 24 V / 1p	
Rated operational current for DC-21 acc. to IEC/EN 60947-3 – Switching of resistive loads including moderate overloads	I_e	A	20 / 24 V / 1p	25 / 24 V / 1p	32 / 24 / V 1p	20 / 24 V / 1p	25 / 24 V / 1p	
Rated operational current for DC-22 acc. to IEC/EN 60947-3 – Switching of mixed resistive and inductive loads, including moderate overloads	I_e	A	16 / 24 V / 1p	20 / 24 V / 1p	25 / 24 V / 1p	16 / 24 V / 1p	20 / 24 V / 1p	
Rated operational current for DC-23 acc. to IEC/EN 60947-3 – Switching of highly inductive loads (e.g. series motors)	I_e	A	10 / 24 V / 1p	16 / 24 V / 1p	20 / 24 V / 1p	10 / 24 V / 1p	16 / 24 V / 1p	
Rated operational current for AC-5a acc. to IEC/EN 60947-4-1 – Switching of electric discharge lamp controls	I_e	A	16 / 230 V					
Rated operational current for AC-5b acc. to IEC/EN 60947-4-1 – Switching of incandescent lamps	I_e	A	10 / 230 V					
Rated operational current for fluorescent lamps acc. to IEC/EN 60669-2-2	I_e	A	16 / 230 V					
Fluorescent / energy saving / compact lamps with electronic control gear	I_e	A	2 / 230 V					
Electrical endurance for all utilization categories						105		
Terminal capacity for main circuit	S	mm^2	1...10 rigid / flexible					
Screw for main circuit						M4		
Screw-head for main circuit						(\pm) PZ2		
Tightening torque for main circuit						1,2		
Terminal capacity for control circuit	S	mm^2	1...4 rigid / flexible					
Screw for control circuit						M3		
Screw-head for control circuit						(\pm) PZ1		
Tightening torque for control circuit						0,6		

ETICON / Bistable switches RBS

Lamps' type	Power (P) [W]	Current (I) [A]	Capacitor (C) [μF]	Maximum number of lamps per pole at 230 V, 50 Hz			
				RBS216	RBS220, RBS420	RBS225, RBS425	RBS232, RBS432
Incandescent lamps and halogen lamps	11	0,05	-				
	15	0,07	-	133	133	167	233
	18	0,08	-	111	111	139	194
	20	0,09	-	100	100	125	175
	25	0,11	-	80	80	100	140
	28	0,12	-	71	71	89	125
	30	0,13	-	67	67	83	117
	33	0,14	-	61	61	76	106
	35	0,15	-	57	57	71	100
	40	0,17	-	50	50	63	88
	42	0,18	-	48	48	60	83
	46	0,2	-	43	43	54	76
	48	0,21	-	42	42	52	73
	50	0,22	-	40	40	50	70
	53	0,23	-	38	38	47	66
	57	0,25	-	35	35	44	61
	60	0,26	-	33	33	42	58
	70	0,3	-	29	29	36	50
	75	0,33	-	27	27	33	47
	77	0,34	-	26	26	32	45
	80	0,35	-	25	25	31	44
	100	0,44	-	20	20	25	35
	116	0,5	-	17	17	22	30
	120	0,52	-	17	17	21	29
	150	0,65	-	13	13	17	23
	160	0,7	-	13	13	16	22
	200	0,87	-	10	10	13	18
	205	0,89	-	10	10	12	17
	230	1	-	9	9	11	15
	300	1,3	-	7	7	8	12
400	1,74	-	5	5	6	9	
500	2,17	-	4	4	5	7	
750	3,26	-	3	3	3	5	
1000	4,35	-	2	2	3	4	
1500	6,52	-	1	1	2	2	
2000	8,7	-	1	1	1	2	
Transformators for low-voltage halogen lamps (electromagnetic and electronic)	10	0,04	-	100	100	200	300
	20	0,09	-	50	75	100	150
	30	0,13	-	33	50	67	100
	40	0,17	-	25	38	50	75
	50	0,22	-	20	30	40	60
	60	0,26	-	17	25	33	50
	70	0,3	-	14	21	29	43
	80	0,35	-	13	19	25	38
	90	0,39	-	11	17	22	33
	100	0,44	-	10	15	20	30
	150	0,65	-	7	10	13	20
	200	0,87	-	5	8	10	15
	300	1,3	-	3	5	7	10
	400	1,74	-	3	4	5	8

Lamps' type	Power (P) [W]	Current (I) [A]	Capacitor (C) [µF]	Maximum number of lamps per pole at 230 V, 50 Hz			
				RBS216	RBS220, RBS420	RBS225, RBS425	RBS232, RBS432
Compact fluorescent lamps with internal ballasts	3	0,04	-	133	167	250	333
	5	0,06	-	80	100	150	200
	6	0,07	-	67	83	125	167
	7	0,08	-	57	71	107	143
	8	0,09	-	50	63	94	125
	9	0,1	-	44	56	83	111
	10	0,11	-	40	50	75	100
	11	0,12	-	36	45	68	91
	12	0,13	-	33	42	63	83
	13	0,14	-	31	38	58	77
	14	0,15	-	29	36	54	71
	15	0,16	-	27	33	50	67
	16	0,18	-	25	31	47	63
	17	0,19	-	24	29	44	59
	18	0,2	-	22	28	42	56
	20	0,21	-	20	25	38	50
	21	0,22	-	19	24	36	48
	22	0,23	-	19	23	34	45
	23	0,24	-	17	22	33	43
	24	0,25	-	17	21	31	42
	25	0,26	-	16	20	30	40
	26	0,27	-	15	19	29	38
	27	0,124	-	15	19	28	37
	30	0,15	-	13	17	25	33
	33	0,155	-	12	15	23	30
	35	0,164	-	11	14	21	29
	40	0,2	-	10	13	19	25
50	0,24	-	8	10	15	20	
70	0,312	-	6	7	11	14	
Compact fluorescent lamps with external electromagnetic ballasts - uncorrected	5	0,05	-	70	120	180	240
	2x5	0,07	-	50	86	129	171
	7	0,05	-	70	120	180	240
	2x7	0,07	-	50	86	129	171
	9	0,06	-	58	100	150	200
	2x9	0,08	-	44	75	113	150
	10	0,07	-	50	86	129	171
	11	0,08	-	44	75	113	150
	13	0,08	-	44	75	113	150
	16	0,1	-	35	60	90	120
	18	0,12	-	29	50	75	100
	2x18	0,21	-	17	29	43	57
	21	0,12	-	29	50	75	100
	22	0,2	-	18	30	45	60
	24	0,15	-	23	40	60	80
	26	0,15	-	23	40	60	80
	28	0,15	-	23	40	60	80
	32	0,22	-	16	27	41	55
	36	0,21	-	17	29	43	57
	38	0,21	-	17	29	43	57
40	0,21	-	17	29	43	57	
58	0,32	-	11	19	28	38	

ETICON / Bistable switches RBS

Lamps' type	Power (P) [W]	Current (I) [A]	Capacitor (C) [μF]	Maximum number of lamps per pole at 230 V, 50 Hz			
				RBS216	RBS220, RBS420	RBS225, RBS425	RBS232, RBS432
Compast fluorescent lamps with external electromagnetic ballasts - parallel corrected	5	0,05	2	40	50	60	75
	2x5	0,07	2	40	50	60	75
	7	0,05	2	40	50	60	75
	2x7	0,07	2	40	50	60	75
	9	0,06	2	40	50	60	75
	2x9	0,08	2	40	50	60	75
	10	0,07	2	40	50	60	75
	11	0,08	2	40	50	60	75
	13	0,08	2	40	50	60	75
	16	0,1	2	40	50	60	75
	18	0,12	4,5	18	22	27	33
	2x18	0,21	4	20	25	30	38
	21	0,12	3	27	33	40	50
	22	0,2	4,5	18	22	27	33
	24	0,15	4,5	18	22	27	33
	26	0,15	4,5	18	22	27	33
	28	0,15	3,5	23	29	34	43
	32	0,22	4	20	25	30	38
	36	0,21	4,5	18	22	27	33
	38	0,21	4,5	18	22	27	33
40	0,21	4,5	18	22	27	33	
58	0,32	7	11	14	17	21	

Lamps' type	Power (P) [W]	Current (I) [A]	Capacitor (C) [μF]	Maximum number of lamps per pole at 230 V, 50 Hz			
				RBS216	RBS220, RBS420	RBS225, RBS425	RBS232, RBS432
Compact fluorescent lamps with external electronic ballasts	5	0,03	-	100	200	300	400
	7	0,04	-	75	150	225	300
	9	0,05	-	60	120	180	240
	2x9	0,09	-	33	67	100	133
	10	0,05	-	60	120	180	240
	2x10	0,09	-	33	67	100	133
	11	0,07	-	43	86	129	171
	2x11	0,12	-	25	50	75	100
	13	0,07	-	43	86	129	171
	2x13	0,12	-	25	50	75	100
	14	0,08	-	38	75	113	150
	2x14	0,15	-	20	40	60	80
	16	0,07	-	43	86	129	171
	17	0,1	-	30	60	90	120
	2x17	0,18	-	17	33	50	67
	18	0,09	-	33	67	100	133
	2x18	0,17	-	18	35	53	71
	22	0,13	-	23	46	69	92
	2x22	0,21	-	14	29	43	57
	24	0,12	-	25	50	75	100
	2x24	0,23	-	13	26	39	52
	3x24	0,32	-	9	19	28	38
	4x24	0,43	-	9	14	21	28
	26	0,12	-	25	50	75	100
	2x26	0,24	-	13	25	38	50
	28	0,14	-	21	43	64	86
	32	0,16	-	19	38	56	75
	2x32	0,31	-	10	19	29	39
	36	0,16	-	19	38	56	75
	2x36	0,31	-	10	19	29	39
	38	0,17	-	18	35	53	71
	2x38	0,35	-	9	17	26	34
	40	0,2	-	15	30	45	60
	2x40	0,39	-	8	15	23	31
	42	0,2	-	15	30	45	60
	2x42	0,41	-	7	15	22	29
	55	0,27	-	11	22	33	44
	2x55	0,52	-	6	12	17	23
	57	0,28	-	11	21	32	43
	2x57	0,57	-	5	11	16	21
60	0,31	-	10	19	29	39	
2x60	0,61	-	5	10	15	20	
70	0,34	-	9	18	26	35	
80	0,38	-	8	16	24	32	
2x80	0,76	-	4	8	12	16	
85	0,42	-	7	14	21	29	
100	0,46	-	7	13	20	26	
120	0,58	-	5	10	16	21	
150	0,69	-	4	9	13	17	

ETICON / Bistable switches RBS

Lamps' type	Power (P) [W]	Current (I) [A]	Capacitor (C) [μF]	Maximum number of lamps per pole at 230 V, 50 Hz			
				RBS216	RBS220, RBS420	RBS225, RBS425	RBS232, RBS432
Fluorescent lamps with external electromagnetic ballasts - uncorrected	4	0,17	-	94	94	94	94
	6	0,16	-	100	100	100	100
	8	0,15	-	107	107	107	107
	10	0,17	-	94	94	94	94
	11	0,16	-	100	100	100	100
	13	0,17	-	94	94	94	94
	14	0,4	-	40	40	40	40
	15	0,33	-	48	48	48	48
	16	0,2	-	80	80	80	80
	18	0,37	-	43	43	43	43
	20	0,38	-	42	42	42	42
	22	0,37	-	43	43	43	43
	25	0,29	-	55	55	55	55
	30	0,37	-	43	43	43	43
	32	0,43	-	37	37	37	37
	36	0,43	-	37	37	37	37
	38	0,43	-	37	37	37	37
	40	0,43	-	37	37	37	37
	58	0,67	-	24	24	24	24
	65	0,67	-	24	24	24	24
	75	0,67	-	24	24	24	24
	80	0,8	-	20	20	20	20
	85	0,8	-	20	20	20	20
100	0,96	-	17	17	17	17	
125	0,94	-	17	17	17	17	
Fluorescent lamps with external electromagnetic ballasts - parallel corrected	4	0,09	2	40	50	60	75
	6	0,08	2	40	50	60	75
	8	0,08	2	40	50	60	75
	10	0,09	2	40	50	60	75
	11	0,08	2	40	50	60	75
	13	0,09	2	40	50	60	75
	14	0,2	4,5	18	22	27	33
	15	0,17	4,5	18	22	27	33
	16	0,1	2,5	32	40	48	60
	18	0,19	4,5	18	22	27	33
	20	0,19	4,5	18	22	27	33
	22	0,19	5	16	20	24	30
	25	0,15	3,5	23	29	34	43
	30	0,24	4,5	18	22	27	33
	32	0,29	5	16	20	24	30
	36	0,29	4,5	18	22	27	33
	38	0,29	4,5	18	22	27	33
	40	0,29	4,5	18	22	27	33
	58	0,46	7	11	14	17	21
	65	0,46	7	11	14	17	21
	75	0,46	6	13	17	20	25
	80	0,57	7	11	14	17	21
	85	0,57	8	10	13	15	19
100	0,66	10	8	10	12	15	
125	0,65	18	4	6	7	8	

Lamps' type	Power (P) [W]	Current (I) [A]	Capacitor (C) [µF]	Maximum number of lamps per pole at 230 V, 50 Hz			
				RBS216	RBS220, RBS420	RBS225, RBS425	RBS232, RBS432
Series circuit for two fluorescent lamps with external electromagnetic ballast - uncorrected	2x4	0,34	-	47	47	47	47
	2x6	0,32	-	50	50	50	50
	2x8	0,3	-	53	53	53	53
	2x10	0,34	-	47	47	47	47
	2x11	0,32	-	50	50	50	50
	2x13	0,34	-	47	47	47	47
	2x14	0,8	-	20	20	20	20
	2x15	0,66	-	24	24	24	24
	2x16	0,4	-	40	40	40	40
	2x18	0,74	-	22	22	22	22
	2x20	0,76	-	21	21	21	21
	2x22	0,74	-	22	22	22	22
	2x25	0,58	-	28	28	28	28
	2x30	0,74	-	22	22	22	22
	2x32	0,86	-	19	19	19	19
	2x36	0,86	-	19	19	19	19
	2x38	0,86	-	19	19	19	19
	2x40	0,86	-	19	19	19	19
	2x58	1,34	-	12	12	12	12
	2x65	1,34	-	12	12	12	12
	2x75	1,34	-	12	12	12	12
	2x80	1,6	-	10	10	10	10
	2x85	1,6	-	10	10	10	10
	2x100	1,92	-	8	8	8	8
2x125	1,88	-	9	9	9	9	
Series circuit for two fluorescent lamps with external electromagnetic ballast - parallel corrected	2x4	0,17	2	40	50	60	75
	2x6	0,16	2	40	50	60	75
	2x8	0,15	2	40	50	60	75
	2x10	0,17	2	40	50	60	75
	2x11	0,16	2	40	50	60	75
	2x13	0,17	2	40	50	60	75
	2x14	0,4	4,5	18	22	27	33
	2x15	0,33	4,5	18	22	27	33
	2x16	0,2	2,5	32	40	48	60
	2x18	0,37	4,5	18	22	27	33
	2x20	0,38	4,5	18	22	27	33
	2x22	0,37	5	16	20	24	30
	2x25	0,29	3,5	23	29	34	43
	2x30	0,37	4,5	18	22	27	33
	2x32	0,43	5	16	20	24	30
	2x36	0,43	4,5	18	22	27	33
	2x38	0,43	4,5	18	22	27	33
	2x40	0,43	4,5	18	22	27	33
	2x58	0,67	7	11	14	17	21
	2x65	0,67	7	11	14	17	21
	2x75	0,67	6	13	17	20	25
	2x80	0,8	7	11	14	17	21
	2x85	0,8	8	10	13	15	19
	2x100	0,96	10	8	10	12	15
2x125	0,94	18	4	6	7	8	
Lead-lag circuit for fluorescent lamps with external electromagnetic ballasts - series corrected	2x18	0,26	2,7	62	62	62	62
	2x36	0,48	4,5	33	33	33	33
	2x40	0,48	4,5	33	33	33	33
	2x58	0,78	7	21	21	21	21
	2x65	0,78	7	21	21	21	21
	2x80	0,96	9	17	17	17	17
	2x85	0,96	9	17	17	17	17
	2x125	1,2	18	13	13	13	13

ETICON / Bistable switches RBS

Lamps' type	Power (P) [W]	Current (I) [A]	Capacitor (C) [μF]	Maximum number of lamps per pole at 230 V, 50 Hz			
				RBS216	RBS220, RBS420	RBS225, RBS425	RBS232, RBS432
Fluorescent lamps with external electronic ballasts	4	0,03	-	100	200	300	400
	6	0,033	-	91	182	273	364
	2x6	0,06	-	50	100	150	200
	8	0,04	-	75	150	225	300
	2x8	0,08	-	38	75	113	150
	10	0,05	-	60	120	180	240
	2x10	0,09	-	33	67	100	133
	11	0,06	-	50	100	150	200
	13	0,07	-	43	86	129	171
	14	0,08	-	38	75	113	150
	2x14	0,15	-	20	40	60	80
	3x14	0,21	-	14	29	43	57
	4x14	0,28	-	11	21	32	43
	15	0,08	-	38	75	113	150
	2x15	0,13	-	23	46	69	92
	16	0,07	-	43	86	129	171
	2x16	0,14	-	21	43	64	86
	3x16	0,2	-	15	30	45	60
	4x16	0,28	-	11	21	32	43
	18	0,09	-	33	67	100	133
	2x18	0,17	-	18	35	53	71
	3x18	0,24	-	13	25	38	50
	4x18	0,31	-	10	19	29	39
	19	0,11	-	27	55	82	109
	2x19	0,22	-	14	27	41	55
	20	0,11	-	27	55	82	109
	2x20	0,22	-	14	27	41	55
	21	0,11	-	27	55	82	109
	2x21	0,22	-	14	27	41	55
	22	0,11	-	27	55	82	109
	2x22	0,23	-	13	26	39	52
	24	0,12	-	25	50	75	100
2x24	0,22	-	14	27	41	55	
3x24	0,33	-	9	18	27	36	
4x24	0,43	-	7	14	21	28	
25	0,15	-	20	40	60	80	
2x25	0,28	-	11	21	32	43	
28	0,14	-	21	43	64	86	
2x28	0,27	-	11	22	33	44	
30	0,14	-	21	43	64	86	
2x30	0,27	-	11	22	33	44	
32	0,17	-	18	35	53	71	

Lamps' type	Power (P) [W]	Current (I) [A]	Capacitor (C) [μF]	Maximum number of lamps per pole at 230 V, 50 Hz			
				RBS216	RBS220, RBS420	RBS225, RBS425	RBS232, RBS432
Fluorescent lamps with external electronic ballasts	2x32	0,35	-	9	17	26	34
	34	0,17	-	18	35	53	71
	2x34	0,35	-	9	17	26	34
	35	0,17	-	18	35	53	71
	2x35	0,34	-	9	18	26	35
	36	0,16	-	19	38	56	75
	2x36	0,31	-	10	19	29	39
	3x36	0,46	-	7	13	20	26
	38	0,15	-	20	40	60	80
	2x38	0,31	-	10	19	29	39
	39	0,19	-	16	32	47	63
	2x39	0,36	-	8	17	25	33
	40	0,21	-	14	29	43	57
	2x40	0,42	-	7	14	21	29
	45	0,24	-	13	25	38	50
	2x45	0,46	-	7	13	20	26
	49	0,24	-	13	25	38	50
	2x49	0,46	-	7	13	20	26
	50	0,25	-	12	24	36	48
	2x50	0,48	-	6	13	19	25
	51	0,22	-	14	27	41	55
	2x51	0,42	-	7	14	21	29
	54	0,26	-	12	23	35	46
	2x54	0,52	-	6	12	17	23
	55	0,28	-	11	21	32	43
	2x55	0,55	-	5	11	16	22
	58	0,25	-	12	24	36	48
	2x58	0,48	-	6	13	19	25
	65	0,25	-	12	24	36	48
	2x65	0,48	-	6	13	19	25
	70	0,3	-	10	20	30	40
	2x70	0,57	-	5	11	16	21
73	0,38	-	8	16	24	32	
2x73	0,7	-	4	9	13	17	
80	0,4	-	8	15	23	30	
2x80	0,76	-	4	8	12	16	
High pressure mercury vapour lamps with external electromagnetic ballasts - uncorrected	50	0,6	-	17	27	27	27
	80	0,8	-	13	20	20	20
	125	1,2	-	8	13	13	13
	250	2,2	-	5	7	7	7
	400	3,3	-	3	5	5	5
	700	5,4	-	2	3	3	3
1000	7,5	-	1	2	2	2	
High pressure mercury vapour lamps with external electromagnetic ballasts - parallel corrected	50	0,3	7	11	14	17	21
	80	0,4	8	10	13	15	19
	125	0,6	10	8	10	12	15
	250	1,2	18	4	6	7	8
	400	1,8	25	3	4	5	6
	700	3,4	40	2	3	3	4
1000	4,8	60	1	2	2	3	

ETICON / Bistable switches RBS

Lamps' type	Power (P) [W]	Current (I) [A]	Capacitor (C) [μF]	Maximum number of lamps per pole at 230 V, 50 Hz			
				RBS216	RBS220, RBS420	RBS225, RBS425	RBS232, RBS432
High pressure mercury vapour lamps which do not require ballasts	160	0,8	-	10	11	14	20
	250	1,2	-	6	7	9	13
	500	2,4	-	3	4	5	7
Metal halide lamps with external electromagnetic ballasts - uncorrected	35	0,5	-	16	32	32	32
	70	1	-	8	16	16	16
	100	1,2	-	7	13	13	13
	150	1,8	-	4	9	9	9
	250	3	-	3	5	5	5
	400	4,6	-	2	3	3	3
	600	6,2	-	1	3	3	3
	1000	9,7	-	1	2	2	2
Metal halide lamps with external electromagnetic ballasts - parallel corrected	2000	12,2	-	0	1	1	1
	35	0,23	6	13	17	20	25
	70	0,42	12	7	8	10	13
	100	0,55	12	7	8	10	13
	150	0,77	20	4	5	6	8
	250	1,26	32	3	3	4	5
	400	2	45	2	2	3	3
	600	3	65	1	2	2	2
Metal halide lamps with external electronic ballasts	1000	5	85	0	1	1	2
	2000	10,5	125	0	0	1	1
	20	0,11	-	27	55	82	109
	35	0,21	-	14	29	43	57
	2x35	0,38	-	8	16	24	32
	50	0,29	-	10	21	31	41
	70	0,38	-	8	16	24	32
	2x70	0,71	-	4	8	13	17
	100	0,56	-	5	11	16	21
	150	0,72	-	4	8	13	17
	250	1,3	-	2	5	7	9
	400	2	-	1	3	5	6
High pressure sodium vapour lamps with external electromagnetic ballasts - uncorrected	1000	5	-	0	1	2	2
	2000	6	-	0	1	2	2
	35	0,53	-	25	30	30	30
	50	0,8	-	16	20	20	20
	70	1	-	13	16	16	16
	100	1,2	-	11	13	13	13
	150	1,8	-	7	9	9	9
	250	3	-	4	5	5	5
	400	4,4	-	3	4	4	4
	600	6,2	-	2	2	2	2
1000	10,3	-	1	1	1	1	

Lamps' type	Power (P) [W]	Current (I) [A]	Capacitor (C) [μF]	Maximum number of lamps per pole at 230 V, 50 Hz			
				RBS216	RBS220, RBS420	RBS225, RBS425	RBS232, RBS432
High pressure sodium vapour lamps with external electromagnetic ballasts - parallel corrected	35	0,22	6	13	17	20	25
	50	0,3	8	10	13	15	19
	70	0,4	12	7	8	10	13
	100	0,55	12	7	8	10	13
	150	0,77	20	4	5	6	8
	250	1,26	32	3	3	4	5
	400	2	45	2	2	3	3
	600	2,9	65	1	1	2	2
High pressure sodium vapour lamps with external electronic ballasts	1000	5,1	100	0	0	1	1
	35	0,21	-	14	29	43	57
	50	0,25	-	12	24	36	48
	70	0,38	-	8	16	24	32
	100	0,56	-	5	11	16	21
	150	0,72	-	4	8	13	17
	250	1,3	-	2	5	7	9
	400	2	-	2	3	5	6
Low pressure sodium vapour lamps with external electromagnetic ballasts - uncorrected	600	3,1	-	1	2	3	4
	1000	5	-	0	1	2	2
	18	0,4	-	25	40	40	40
	35	0,6	-	15	27	27	27
	55	0,6	-	15	27	27	27
Low pressure sodium vapour lamps with external electromagnetic ballasts - parallel corrected	90	0,9	-	10	18	18	18
	135	0,9	-	10	18	18	18
	180	0,9	-	10	18	18	18
	18	0,35	5	16	20	24	30
	35	0,28	20	4	5	6	8
Low pressure sodium vapour lamps with ECG	55	0,35	20	4	5	6	8
	90	0,55	26	3	4	5	6
	135	0,8	40	2	3	3	4
LED lamps	180	1	40	2	3	3	4
	35	0,16	-	19	38	56	75
Power supplies for LEDs	55	0,25	-	12	24	36	48
	-	-	-	max. 2 A per pole	max. 6 A per pole	max. 9 A per pole	max. 12 A per pole

ETICON

Miniature and motor contactors, auxiliary contactors and overload relays

- Miniature contactors CEC have possibility to be mounted on printed circuit board with special connection module.

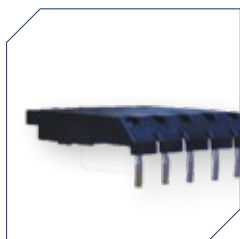

- Contactors CEI series (kit) with mechanical interlock - solution for Reversing the motor or implementation of schemes star delta



- Special socket for RC noise filters (surge suppressors)



- Additional time delay relays mounted on side of contactor



- Mechanical interlock assures also mounting of auxiliary contacts



- Front mounted auxiliary contact block



- Overload protection relays (bimetal)



Technical data

Type			CE07	CEC07	CEC09	CEC012	CEC016	CECA0	CAE04
Standards			IEC/EN 60 947, DIN VDE 0660, UL, CSA						
Rated insulation voltage U_i according to IEC/EN 60947, DIN VDE 0660	V		415 V			690 V			415 V
Rated impulse withstand voltage U_{imp}						4 kV			
Rated operational frequency						25 - 400 Hz			
Degree of protection									
Main circuits						IP20			
Control circuits and auxiliary contacts						IP20			
Ambient temperature									
Operating temperature						-25 ... +550C			
Storage temperature						-55 ... +800C			
Altitude									
Normal values						< 3000 m			
90% $I_e/80\% U_e$						3000 ... 4000 m			
80% $I_e/75\% U_e$						4000 ... 5000 m			
Overvoltage category / Pollution degree						III/3			
Climatic proofing						IEC 60 680-2			
Number of main poles			3		3			4	4
Rated operational voltage U_e			400-415 V			690 V			400-415 V
Conv. thermal current I_{th} at < 550C									
rated operational current I_e /AC-1			16 A	18 A	20 A	22 A	22 A	10 A	16 A
AC3 Utilization category									
Rated operational power									
	230 V	kW	1,5	1,5	2,2	3	4	-	-
	400/415 V	kW	3	3	4	5,5	7,5	-	-
	440 V	kW	-	3,7	4,5	5,5	7,5	-	-
	500 V	kW	-	3,7	4,5	5,5	7,5	-	-
	690 V	kW	-	3,7	5,5	7,5	7,5	-	-
AC4 Utilization category									
Rated operational current I_e AC-4 ($U_e \leq 440V$)				2,8	3,5	4,5	5		
Short circuit rating, max. fuse gG (A)			16	20	20	25	25	6	6
Max. electrical operating frequency									
AC-1		Ops/h	50			300		-	-
AC-3		Ops/h	300			600		-	-
AC-4		Ops/h	250			300		-	-
no load		Ops/h	2000			2500		2500	2500
Mechanical life span		Ops x 106				10			
Electrical life span		Ops x 106	0,8	1,4	1,3	1,2	1,1	1	1
Maximum number of auxiliary contacts						5		-	-
Rated operational current I_e									
AC-15	220-230 V	A	-	-	-	-	-	10	6
	380-400 V	A	-	-	-	-	-	6	4
	415 V	A	-	-	-	-	-	5	-
	500 V	A	-	-	-	-	-	4	-
	690 V	A						2	
DC-13	24 V	A	-	-	-	-	-	6,0	2,5
	48 V	A	-	-	-	-	-	4,0	1,5
	110 V	A	-	-	-	-	-	2	0,7
	220 V	A	-	-	-	-	-	0,7	0,35
Auxiliary contacts reliability								$U_{e\ min} = 17V$, $I_{e\ min} = 5mA$	$U_{e\ min} = 24V$, $I_{e\ min} = 30mA$
Terminal capacity		mm ²				1 x / 2 x (0,5...2,5)			
Tightening torque		Nm	0,8			1...1,5			0,8

Technical data

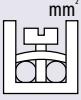
Type	CE07	CEC07	CEC09	CEC012	CEC016	CECA0	CAE04
Terminal capacity	 1 x / 2 x (0,5...2,5)						
Tightening torque	Nm		0,8	1...1,5		0,8	
Control circuit							
Power consumption of the coil	AC	Closing	VA	20	30		20
		Cosφ			0,8		
		Closed	VA	3,3...5,5	2...3		3,3...5,5
		Cosφ		0,2	0,27		0,2
	DC		W	-	2,6...3,7		-
Switching time	Closing/opening (AC)		ms	9...30 / 5...25	8...20 / 6...13		9...30 / 5...25
	Closing/opening (DC)		ms	-	35...45 / 7...12		-
Coils rated voltage			V	12-660 VAC		12-660 VAC / 12-440 VDC	
Coil operational limits				0,85...1,1			

Power dissipation

Models	Power dissipation per auxiliary contact pole	Power dissipation per pole	Power dissipation per pole	Thermal power dissipation	
	AC-13	AC-3	AC-1	AC coil	DC coil
CE07	0,6 W	0,3 W	-	2,3 W	-
CEI7	0,6 W	0,3 W	-	2,3 W	-
CAE04	0,6 W	-	-	2,3 W	-
CECA0	0,6 W	-	-	1 W	3,15 W
CEC07 3P	0,6 W	0,3 W	1,9 W	1 W	3,15 W
CEC07 4P	-	0,3 W	1,9 W	1 W	3,15 W
CEC09 3P	0,6 W	0,5 W	2,4 W	1 W	3,15 W
CEC09 4P	-	0,5 W	2,4 W	1 W	3,15 W
CEC012 3P	0,6 W	0,7 W	2,4 W	1 W	3,15 W
CEC012 4P	-	0,7 W	2,4 W	1 W	3,15 W
CEC016 3P	0,6 W	1,3 W	2,4 W	1 W	3,15 W
CEC016 4P	-	1,3 W	2,4 W	1 W	3,15 W

Diagram

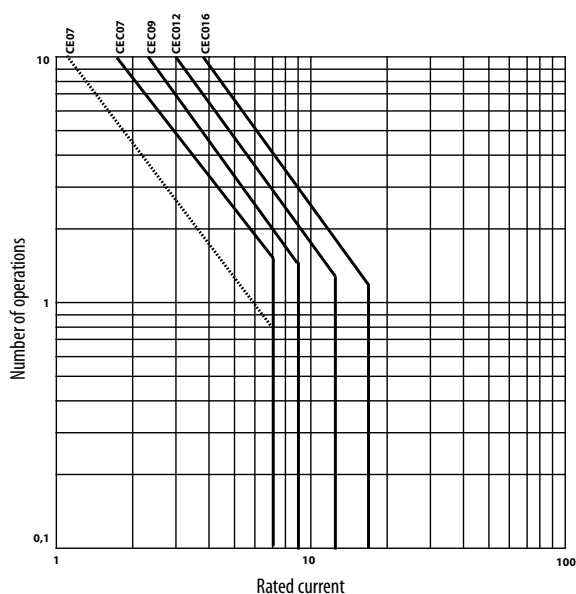

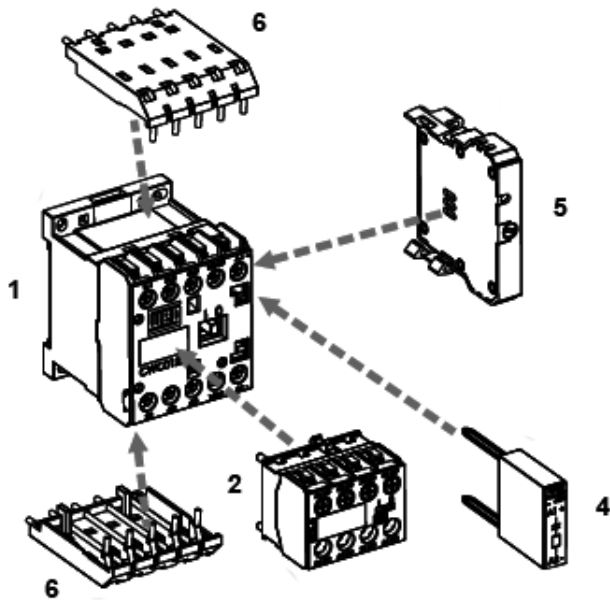

- 1 - Mini contactor
- 2 - Auxiliary frontal contacts block
- 3 - Mechanical interlock block
- 4 - Surge suppressor blocks
- 5 - Timer
- 6 - Link module for printed circuit board

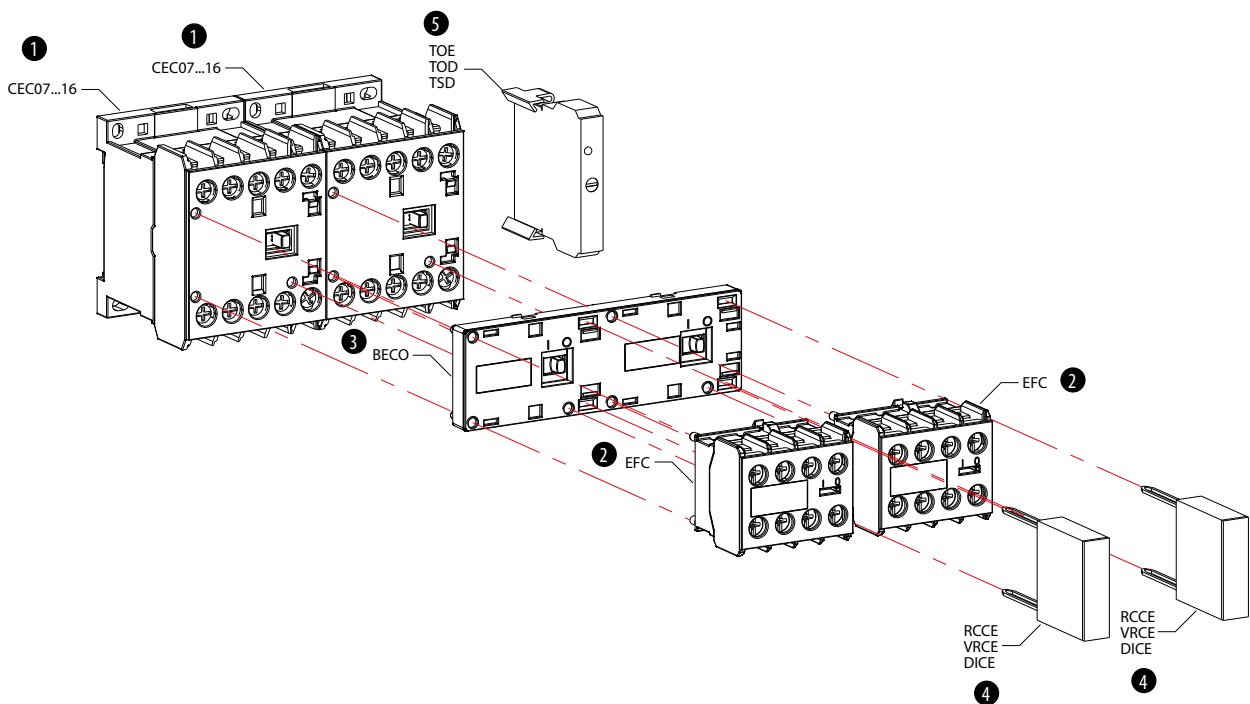

Miniature and auxiliary contactor CE, CAE, CEI7

Application:

Miniature contactors are used to remotely control and protect (in combination with overload relays) electric motors and other electric loads with nominal power up to 7,5kW (at 400V AC3 duty), and auxiliary contactors are used for realizing a wide range of control circuits.

Advantages:

- /// Mounting on DIN rail and mounting plates
- /// Small size and high technical performance
- /// Low power loss (current heat loss)
- /// Protection against direct contact from front (IEC 536) IP20
- /// Wide range of accessories
- /// Surge suppressor (as option)
- /// Reversing starter with mechanical interlock
- /// Control voltage 24VAC, 48VAC, 110VAC, 230VAC, 400VAC

Miniature contactor CE07, 16 A (AC1), 7A, 3 kW (AC3)

Type	Code No.	Wiring diagram	g	
CE07.10-24V-50/60Hz	004641020			
CE07.10-48V-50/60Hz	004641021			
CE07.10-110V-50/60Hz	004641022		130	1
CE07.10-230V-50/60Hz	004641023			
CE07.10-400V-50/60Hz	004641024			
CE07.01-24V-50/60Hz	004641010			
CE07.01-48V-50/60Hz	004641011			
CE07.01-110V-50/60Hz	004641012		130	1
CE07.01-230V-50/60Hz	004641013			
CE07.01-400V-50/60Hz	004641014			



Miniature contactor relay CAE0; 6A (AC15, 230V)



Type	Code No.	Wiring diagram	g	
CAE04.22-230V-50/60Hz	004641343			
CAE04.22-24V-50/60Hz	004641340			
CAE04.31-230V-50/60Hz	004641363			
CAE04.31-24V-50/60Hz	004641360		180	1
CAE04.13-230V-50/60Hz	004641353			
CAE04.13-24V-50/60Hz	004641350			
CAE04.40-230V-50/60Hz	004641383			
CAE04.40-24V-50/60Hz	004641380			



Miniature contactor-reversing starter with mechanical interlock CEI07.10, 16A (AC1), 3,5A, 1,5 kW (AC3)

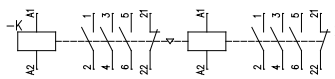

Type	Code No.	Wiring diagram	g	
CEI7.10-24V-50/60Hz	004641620			
CEI7.10-48V-50/60Hz	004641621			
CEI7.10-110V-50/60Hz	004641622		250	1
CEI7.10-230V-50/60Hz	004641623			
CEI7.10-400V-50/60Hz	004641624			

Miniature contactor-reversing starter with mechanical interlock CEI07.01, 16A (AC1), 3,5A, 1,5 kW (AC3)

Type	Code No.	Wiring diagram	 g	
CEI7.01-24V-50/60Hz	004641610		250	1
CEI7.01-48V-50/60Hz	004641611			
CEI7.01-110V-50/60Hz	004641612			
CEI7.01-230V-50/60Hz	004641613			
CEI7.01-400V-50/60Hz	004641614			



Surge suppressor

Type	Code No.	Coil voltage	For use with	 g	
RCE01	004641701	24-48 VAC	CE07, CEI07	14	1
RCE06	004641702	110-220 VAC	CE07, CEI07	14	1
RCE10	004641703	380-400 VAC	CE07, CEI07	14	1

Dimensions

CE07

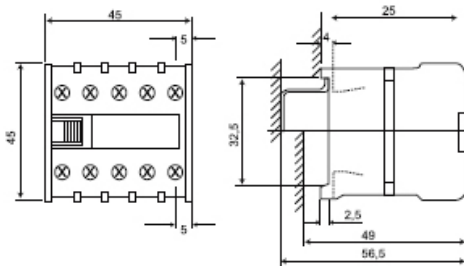

Mounting

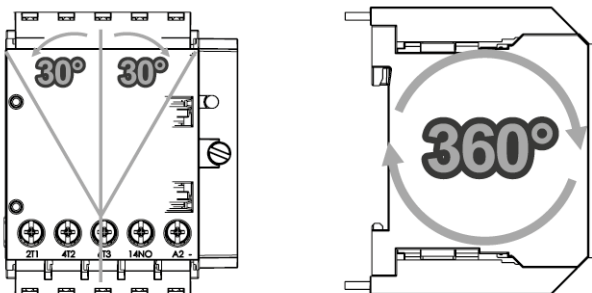

Miniature and auxiliary contactor CEC

Application:

Miniature contactors are used to remotely control and protect (in combination with overload relays) electric motors and other electric loads with nominal power up to 7,5kW (at 400V AC3 duty), and auxiliary contactors are used for realizing a wide range of control circuits.



Advantages:

- // Mounting on DIN rail and mounting plates
- // Small size and high technical performance
- // Low power loss (current heat loss)
- // Protection against direct contact from front (IEC 536) IP20
- // Wide range of accessories
- // Surge suppressor (as option)
- // Reversing starter with mechanical interlock
- // Control voltage 24VAC, 48VAC, 110VAC, 230VAC, 400VAC, 24 VDC, 48 VDC, 110 VDC, 220 VDC

Example of CEC configuration:



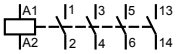
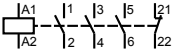

Miniature contactors CEC07; 18A(AC1); 7A,3kW(AC3 400V)

Type	Code No.	Wiring diagram		
CEC07.10-24V-50/60Hz	004641050			
CEC07.10-42V-50/60Hz	004641051			
CEC07.10-48V-50/60Hz	004641052			
CEC07.10-110V-50/60Hz	004641053			
CEC07.10-230V-50/60Hz	004641054		180	1
CEC07.10-400V-50/60Hz	004641055			
CEC07.10-24VDC	004641100			
CEC07.10-48VDC	004641130			
CEC07.10-110VDC	004641131			
CEC07.10-220VDC	004641132			
CEC07.01-24V-50/60Hz	004641056			
CEC07.01-42V-50/60Hz	004641057			
CEC07.01-48V-50/60Hz	004641058			
CEC07.01-110V-50/60Hz	004641059			
CEC07.01-230V-50/60Hz	004641060		180	1
CEC07.01-400V-50/60Hz	004641061			
CEC07.01-24VDC	004641101			
CEC07.01-48VDC	004641133			
CEC07.01-110VDC	004641134			
CEC07.01-220VDC	004641135			



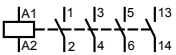
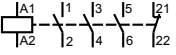

Miniature contactors CEC09; 20A(AC1); 9A,4kW(AC3, 400V)



Type	Code No.	Wiring diagram		
CEC09.10-24V-50/60Hz	004641062			
CEC09.10-42V-50/60Hz	004641063			
CEC09.10-48V-50/60Hz	004641064		180	1
CEC09.10-110V-50/60Hz	004641065			
CEC09.10-230V-50/60Hz	004641066			
CEC09.10-400V-50/60Hz	004641067			
CEC09.10-24VDC	004641102			
CEC09.10-48VDC	004641136		218	1
CEC09.10-110VDC	004641137			
CEC09.10-220VDC	004641138			
CEC09.01-24V-50/60Hz	004641068			
CEC09.01-42V-50/60Hz	004641069			
CEC09.01-48V-50/60Hz	004641070		180	1
CEC09.01-110V-50/60Hz	004641071			
CEC09.01-230V-50/60Hz	004641072			
CEC09.01-400V-50/60Hz	004641073			
CEC09.01-24VDC	004641103			
CEC09.01-48VDC	004641139		218	1
CEC09.01-110VDC	004641140			
CEC09.01-220VDC	004641141			

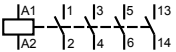
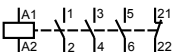

Miniature contactors CEC012; 22A(AC1); 12A,5,5kW(AC3 400V)

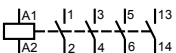
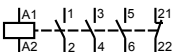

Type	Code No.	Wiring diagram					
CEC012.10-24V-50/60Hz	004641074		180	1			
CEC012.10-42V-50/60Hz	004641075						
CEC012.10-48V-50/60Hz	004641076						
CEC012.10-110V-50/60Hz	004641077						
CEC012.10-230V-50/60Hz	004641078						
CEC012.10-400V-50/60Hz	004641079						
CEC012.10-24VDC	004641104					218	1
CEC012.10-48VDC	004641142						
CEC012.10-110VDC	004641143						
CEC012.10-220VDC	004641144						
CEC012.01-24V-50/60Hz	004641080						
CEC012.01-42V-50/60Hz	004641081						
CEC012.01-48V-50/60Hz	004641082						
CEC012.01-110V-50/60Hz	004641083						
CEC012.01-230V-50/60Hz	004641084						
CEC012.01-400V-50/60Hz	004641085						
CEC012.01-24VDC	004641105	218	1				
CEC012.01-48VDC	004641145						
CEC012.01-110VDC	004641146						
CEC012.01-220VDC	004641147						

**Miniature contactors CEC016; 22A(AC1); 16A,7,5kW(AC3 400V)**

Type	Code No.	Wiring diagram					
CEC016.10-24V-50/60Hz	004641086		180	1			
CEC016.10-42V-50/60Hz	004641087						
CEC016.10-48V-50/60Hz	004641088						
CEC016.10-110V-50/60Hz	004641089						
CEC016.10-230V-50/60Hz	004641090						
CEC016.10-400V-50/60Hz	004641091						
CEC016.10-24VDC	004641106					218	1
CEC016.10-48VDC	004641148						
CEC016.10-110VDC	004641149						
CEC016.10-220VDC	004641150						
CEC016.01-24V-50/60Hz	004641092						
CEC016.01-42V-50/60Hz	004641093						
CEC016.01-48V-50/60Hz	004641094						
CEC016.01-110V-50/60Hz	004641095						
CEC016.01-230V-50/60Hz	004641096						
CEC016.01-400V-50/60Hz	004641097						
CEC016.01-24VDC	004641107	218	1				
CEC016.01-48VDC	004641151						
CEC016.01-110VDC	004641152						
CEC016.01-220VDC	004641153						

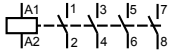
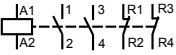

4-pole miniature contactors

Type	Code No.	Wiring diagram					
CEC07.4P-230V-50/60Hz	004641200		180	1			
CEC09.4P-230V-50/60Hz	004641201						
CEC012.4P-230V-50/60Hz	004641202						
CEC016.4P-230V-50/60Hz	004641203						
CEC07.4P-24VDC	004641210						
CEC09.4P-24VDC	004641211						
CEC012.4P-24VDC	004641212						
CEC016.4P-24VDC	004641213						
CEC07.PR-230V-50/60HZ	004641204					180	1
CEC09.PR-230V-50/60HZ	004641205						
CEC012.PR-230V-50/60HZ	004641206						
CEC016.PR-230V-50/60HZ	004641207						
CEC07.PR-24V-DC	004641214						
CEC09.PR-24V-DC	004641215						
CEC012.PR-24V-DC	004641216						
CEC016.PR-24V-DC	004641217						



Dimensions

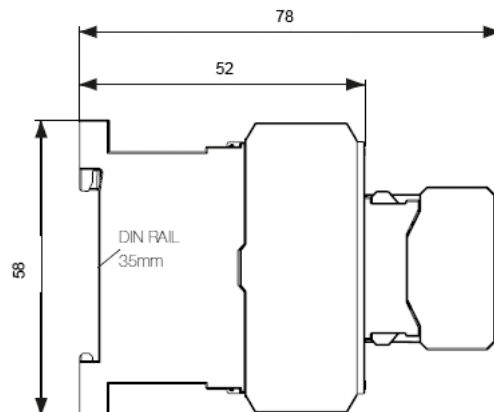
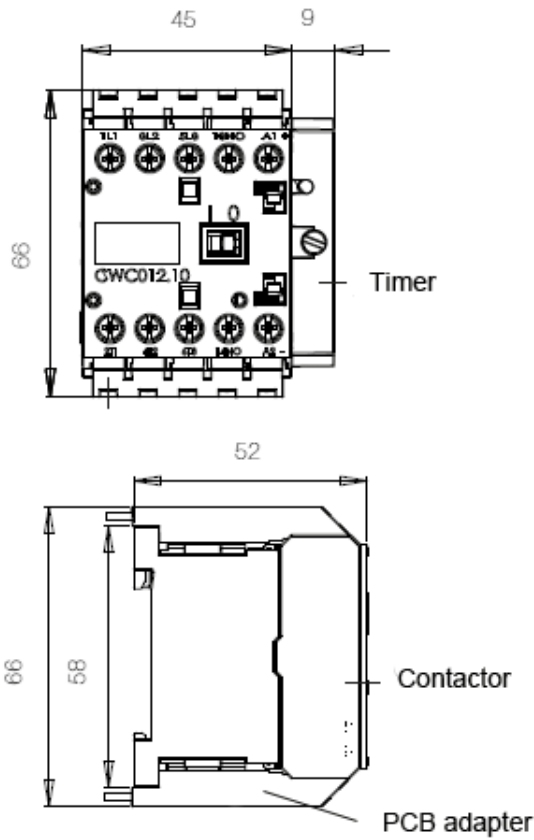

- Dimensions with PCB adapter

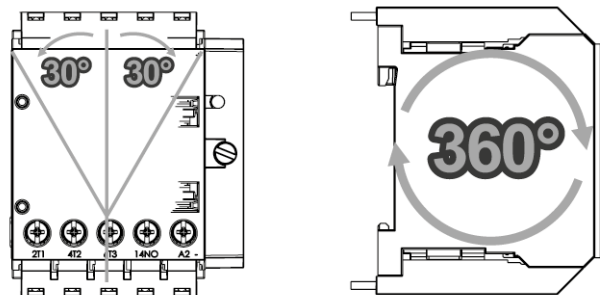

Mounting



Surge suppressor

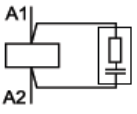
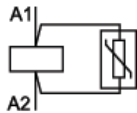
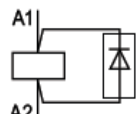

Type	Code No.	voltage	Wiring diagram		
RCCE-1	004641720	12-24V 50/60Hz		6	1
RCCE-2	004641721	24-48V 50/60Hz			
RCCE-3	004641722	48-127V 50/60Hz			
RCCE-4	004641723	127-250V 50/60Hz			
RCCE-5	004641724	250-380V 50/60Hz			
RCCE-6	004641725	380-510V 50/60Hz			
VRCE-1	004641726	12-48V AC/12-60V DC		6	1
VRCE-2	004641727	50-127V AC/60-180V DC			
VRCE-3	004641728	130-275V AC/180-300V DC			
VRCE-4	004641729	277-380V AC/300-510V DC			
VRCE-5	004641730	400-510V AC			
DICE-1	004641731	12-600V DC		6	1

**Mechanical interlock**

Type	Code No.		
BECC	004643603	15	1



For use with CEC

**Printed circuit board adapter**

Type	Code No.		
CECO	004642720	126	1









For use with CEC

**Overload relay RE17D**

Type	Code No.	Current setting range [A]	For use with		
RE17D-0,4	004641400	0,28-0,4	CEC07 – CEC016	150	1
RE17D-0,63	004641401	0,4-0,63			
RE17D-0,8	004641402	0,56-0,8			
RE17D-1,2	004641403	0,8-1,2			
RE17D-1,8	004641404	1,2-1,8			
RE17D-2,8	004641405	1,8-2,8			
RE17D-4,0	004641406	2,8-4,0			
RE17D-6,3	004641407	4-6,3			
RE17D-8,0	004641408	5,6-8			
RE17D-10	004641409	7-10			
RE17D-12,5	004641410	8-12,5			
RE17D-15	004641411	10-15			
RE17D-17	004641412	11-17			

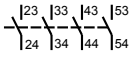
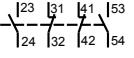
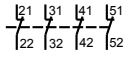
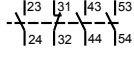
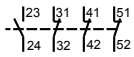

Auxiliary contact blocks

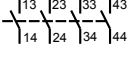
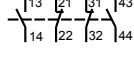
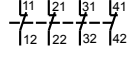
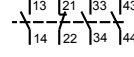
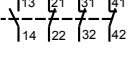
Type	Code No.	Wiring diagram	For use with	 g	
EFCO-20	004641520				
EFCO-11	004641521				
EFCO-02	004641522				
EFCO-40	004641523		CECO 3 pole	28	1
EFCO-22	004641524				
EFCO-04	004641525				
EFCO-31	004641526				
EFCO-13	004641527				
EFC4-20	004641540				
EFC4-11	004641541				
EFC4-02	004641542				
EFC4-40	004641543		CECO 4 pole	28	1
EFC4-22	004641544				
EFC4-04	004641545				
EFC4-31	004641546				
EFC4-13	004641547				



EFCO



EFC4



EFC4



Example of using EFCO and RCCE



Auxiliary contact block

Standards			IEC 60947-5-1, IEC 60947-4-1
Rated insulation voltage U_i	IEC, VDE 0660	(V)	1000
Rated operational voltage U_e	IEC, VDE 0660	(V)	690
Conv. thermal current I_{th}		A	10
Rated operational current (I_c)			
AC-15(IEC 60947-5-1)	$U_e \leq 240V$	(A)	10
	380-400V	(A)	6
	415-440V	(A)	6
	500V	(A)	4
	660-690V	(A)	-
UL, CSA 1)			A600
DC-13(IEC 60947-5-1)	24V	(A)	1,5
	60V	(A)	0,5
	110V	(A)	0,4
	220-240V	(A)	0,4
UL, CSA 1)			Q600
Short circuit protection max. fuse gL/gG		(A)	10
Control circuit reliability		(V / mA)	17 / 5
Electrical life span		c. op.	1.000.000
Mechanical life span		c. op.	10.000.000
Nr. of conductors and cross section	Stranded without end sleeve	mm ²	2x (0,5...2,5)
Tightening torque		Nm	0,8...1,5

Electronic timer blocks TOE, TOD, TSD



Inputs	Rated insulation voltage (U_i)		V	300
	Supply voltage (U_e)	1 - 2 terminals	V	24...240 V AC/DC 50/60 Hz (TOE)
				24...60 V AC/DC 50/60 Hz (TOD)
				100...60 V AC/DC 50/60 Hz (TOD)
				220-240 V AC 50/60 Hz (TSD)
				110-130 V AC (TSD)
	24-28 V AC 50/60 Hz (TSD)			
Command (U_c) (only TOD)	2 - B1 terminals	V	24...60 V AC/DC 50/60 Hz (TOD)	
			100...240 V AC/DC 50/60 Hz (TOD)	
Voltage limits			0,85 - 1,1 x U_c -> AC	
			0,8 - 1,25 x U_c -> DC	
Consumption			mA	≤ 5
Time adjustment	Min. time for Reset		ms	100
	Min. command time (only TOD)		ms	50
	Setting accuracy (% of the full scale value)		%	+/-5
	Repeat accuracy		%	+/-1
	Changeover time $Y - \Delta$		ms	50

Electronic timing relays

Type	Code No.	Time	Supply Voltage		
ON delay					
TOE-3-24-240	004642730	0,3-3 sec	24-240V AC/DC	126	1
TOE-10-24-240	004642731	1-10 sec			
TOE-30-24-240	004642732	3-30 sec			
TOE-60-24-240	004642733	6-60 sec			
TOE-100-24-240	004642734	10-100 sec			
TOE-300-24-240	004642735	30-300 sec			
TOE-1800-24-240	004642736	180-1800 sec			
OFF delay					
TOD-3-24-60	004642740	0,3-3 sec	24-60V AC/DC	126	1
TOD-10-24-60	004642741	1-10 sec			
TOD-30-24-60	004642742	3-30 sec			
TOD-60-24-60	004642743	6-60 sec			
TOD-100-24-60	004642744	10-100 sec			
TOD-300-24-60	004642745	30-300 sec			
TOD-1800-24-60	004642746	180-1800 sec			
TOD-3-100-240	004642747	0,3-3 sec	110-240V AC/DC	126	1
TOD-10-100-240	004642748	1-10 sec			
TOD-30-100-240	004642749	3-30 sec			
TOD-60-100-240	004642750	6-60 sec			
TOD-100-100-240	004642751	10-100 sec			
TOD-300-100-240	004642752	30-300 sec			
TOD-1800-100-240	004642753	180-1800 sec			
Star-delta					
TSD-30-24-28	004642760	3-30 sec	24-48V AC	126	1
TSD-30-110-130	004642761		110-130V AC		
TSD-30-220-240	004642762		220 - 240V AC		

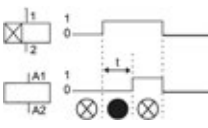
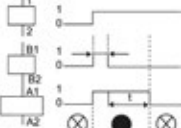
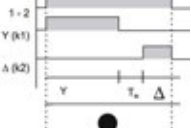

Diagrams

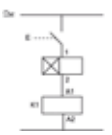
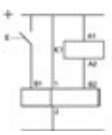
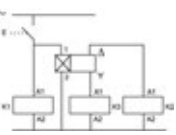
Function	ON Delay TOE	OFF Delay TOD	Star - delta TSD										
Functional diagram													
LED on													
LED off													
Schemes	<p>Terminals</p> <table border="1"> <tr><td>1</td></tr> <tr><td>2</td></tr> </table> 	1	2	<p>Terminals</p> <table border="1"> <tr><td>(+)1</td></tr> <tr><td>B1</td></tr> <tr><td>(-)2</td></tr> <tr><td>B2</td></tr> </table> 	(+)1	B1	(-)2	B2	<p>Terminals</p> <table border="1"> <tr><td>1</td></tr> <tr><td>2</td></tr> <tr><td>D</td></tr> <tr><td>Y</td></tr> </table> 	1	2	D	Y
1													
2													
(+)1													
B1													
(-)2													
B2													
1													
2													
D													
Y													

Motor contactor CES

ETICON CES SERIES

IEC 60947-4-1

Contact reliability

Contactors are used to remotely control and protect (in combination with overload relays) electric motors and other electric loads with nominal power up to 200kW (at 400V AC3 duty)

Auxiliary contacts

CES 6 to CES 45:

Up to 4 auxiliary contact blocks with 1 NO or 1 NC contact can be snapped onto the basic units (front).

CES 65 to CES 105:

Maximum 4 auxiliary contact blocks with 1 NO + 1 NC contacts (lateral) assembled.

When the contactors are energized, the NC contacts open before the NO contacts close.

CES 65..400 NOT POSSIBLE TO MOUNT ON DIN RAIL



Ordering:

CES	9	.	0	1	-	230V	-	50/60Hz
1	2	3	4	5	6			

- 1 - Contactor type
- 2 - Rated operational current Ie (AC3)
- 3 - Number and type NO auxiliary contacts
- 4 - Number and type NC auxiliary contacts
- 5 - Coil voltage
- 6 - Frequency

✓ CES 40...105 contactor terminals allow simultaneous connection not only single-stranded and stranded conductors, but also conductors of different sections.

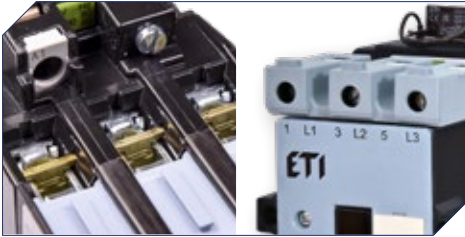

✓ Additional EMC filters can be installed (CES 140...400 have already integrated).



✓ Voltage range control at 230 V AC: from 0.85 up to 1.15 x Us in accordance with IEC 60947.



✓ CES 6...45 additional aux. contact blocks can be installed on front of device.



✓ Design allows to mount contactor on DIN rail TH 35 or directly on panel



✓ Additional 2nd aux. contact block can be installed on each side of contactor CES65...300.

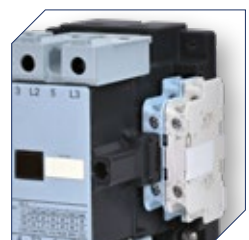

✓ Overload relays (bimetal) tripping class 10



✓ Mechanical interlock can be installed between 2 contactors.



✓ Possible to mount overload relay directly on contactor or DIN rail TH 35 with mounting adapter CES-AD-RT



Contact endurance of the main contacts

The characteristic curves show the contact endurance of contactors when switching resistive and inductive three-phases

loads (AC-1/AC-3) depending on the breaking current and the rated operational voltage. It is assumed that the control devices operate randomly, i.e. not in synchronism with the phase angle of the supply system.

The rated operational current I_e for AC-4 duty (breaking 6 times the rated operational current) is selected for a contact endurance of approximately 200,000 operating cycles.

If a shorter endurance is sufficient, the rated operational current I_e / AC-4 can be increased.

If mixed operation is involved, i.e. normal switching (breaking of rated operational current in AC-3 duty) with intermittent inching (breaking multiples of the rated operational current in AC-4 duty) the contact endurance can be calculated approximately from the following equation:

$$X = \frac{A}{1 + \frac{C}{100} \left(\frac{A}{B} - 1 \right)}$$

Legend to the equation:

X Contact endurance for mixed operation in operating cycles

A Contact endurance for normal operation ($I_a = I_e$) in operating cycles

B Contact endurance for inching ($I_a =$ multiple of I_e) in operating cycles

C Percentage of inching operations in total operations

Short-circuit protection of CES 6 to CES 105 contactors without overload relay

Fuses, utilization category gG

or miniature circuit-breaker with C-characteristics

Technical data

Contactor	Type	CES 6	CES 9	CES 12	CES 18	CES 25	CES 32
Main circuit							
With fuses							
- acc. to IEC 60947-4-1	Type of coordination "1" ¹⁾	A	32	32	32	63	63
	Type of coordination "2" ¹⁾	A	20	20	25	40	40
- weld-free ²⁾	$I_k \geq 100 \times I_e$	A	10	10	10	16	16
With miniature circuit breaker	C-characteristic	A	16	16	25	25	--
Auxiliary circuit (short circuit current $I_k \geq 1$ kA)							
Contactor	Size	0 ... 1					
	Type	CES 6 ... CES 32					
With fuses	A	16					
	A	6, if overload relay auxiliary contacts are in the contactor coil circuit					
with miniature circuit-breaker	A	10					
with C-characteristics	A	3, if overload relay auxiliary contacts are in the contactor coil circuit					
Contactor	Type	CES 40	CES 45	CES 65	CES 75	CES 85	CES 105
Main circuit							
With fuses							
- acc. to IEC 60947-4-1	Type of coordination "1" ¹⁾	A	80	80	160	160	250
	Type of coordination "2" ¹⁾	A	63	63	100	100	125
- weld-free ²⁾	$I_k \geq 100 \times I_e$	A	25	25	63	80	125
With miniature circuit breaker	C-characteristic	A	--	--	--	--	--
Auxiliary circuit (short circuit current $I_k \geq 1$ kA)							
Contactor	Size	0 ... 4					
	Type	CES 40 ... CES 105					
With fuses	A	16					
	A	6, if overload relay auxiliary contacts are in the contactor coil circuit					
with miniature circuit-breaker	A	10					
with C-characteristics	A	3, if overload relay auxiliary contacts are in the contactor coil circuit					



1) In accordance with IEC 60947-4-1:

Type of coordination "1": Destruction of contactor and overload relay is admissible. Contactor and/or overload relay must be replaced if necessary.

Type of coordination "2": No damage can be tolerated on the overload relay, but contact welding on the contactor is permitted if the contacts can easily be separated.

2) Test conditions according to IEC 60947-4-1.

Motor contactor CES 6; 25A(AC1); 6A/2,2kW(AC3, 400V)

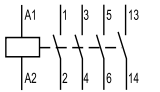
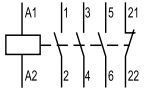

Type	Code No.	Wiring diagram		
CES 6.10-24V-50/60Hz	004646500		370	1
CES 6.10-110V-50/60Hz	004646503		370	1
CES 6.10-230V-50/60Hz	004646501		370	1
CES 6.10-400V-50Hz	004646502		370	1
CES 6.10-24V DC	004646504		0,58	1
CES 6.01-24V-50/60Hz	004646505		370	1
CES 6.01-110V-50/60Hz	004646508		370	1
CES 6.01-230V-50/60Hz	004646506		370	1
CES 6.01-400V-50Hz	004646507		370	1
CES 6.01-24V DC	004646509		580	1

CES 6.10 - Integrated auxiliary contact 1xNO; CES 6.01 - Integrated auxiliary contact 1xNC



CES 6

Motor contactor CES 9; 25A(AC1); 9A/4kW(AC3, 400V)

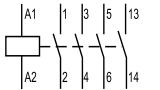
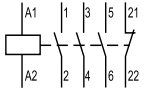

Type	Code No.	Wiring diagram		
CES 9.10-24V-50/60Hz	004646510		370	1
CES 9.10-110V-50/60Hz	004646511		370	1
CES 9.10-230V-50/60Hz	004646512		370	1
CES 9.10-400V-50Hz	004646513		370	1
CES 9.10-24V DC	004646514		580	1
CES 9.01-24V-50/60Hz	004646515		370	1
CES 9.01-110V-50/60Hz	004646516		370	1
CES 9.01-230V-50/60Hz	004646517		370	1
CES 9.01-400V-50Hz	004646518		370	1
CES 9.01-24V DC	004646519		580	1

CES 9.10 - Integrated auxiliary contact 1xNO; CES 9.01 - Integrated auxiliary contact 1xNC



CES 9

Motor contactor CES 12; 25A(AC1); 12A/5,5kW(AC3, 400V)

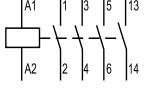
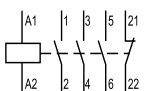

Type	Code No.	Wiring diagram		
CES 12.10-24V-50/60Hz	004646520		370	1
CES 12.10-110V-50/60Hz	004646521		370	1
CES 12.10-230V-50/60Hz	004646522		370	1
CES 12.10-400V-50Hz	004646523		370	1
CES 12.10-24V DC	004646524		580	1
CES 12.10-42V-50/60Hz	004646525		370	1
CES 12.01-24V-50/60Hz	004646526		370	1
CES 12.01-110V-50/60Hz	004646527		370	1
CES 12.01-230V-50/60Hz	004646528		370	1
CES 12.01-400V-50Hz	004646529		370	1
CES 12.01-24V DC	004646530		580	1

CES 12.10 - Integrated auxiliary contact 1xNO; CES 12.01 - Integrated auxiliary contact 1xNC



CES 12

Motor contactor CES 18; 25A(AC1); 18A/7,5kW(AC3, 400V)

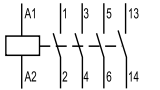
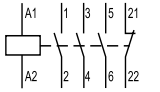

Type	Code No.	Wiring diagram		
CES 18.10-24V-50/60Hz	004646531		370	1
CES 18.10-110V-50/60Hz	004646532		370	1
CES 18.10-230V-50/60Hz	004646533		370	1
CES 18.10-400V-50Hz	004646534		370	1
CES 18.10-24V DC	004646535		580	1
CES 18.01-24V-50/60Hz	004646536		370	1
CES 18.01-110V-50/60Hz	004646537		370	1
CES 18.01-230V-50/60Hz	004646538		370	1
CES 18.01-400V-50Hz	004646539		370	1
CES 18.01-24V DC	004646540		580	1

CES 18.10 - Integrated auxiliary contact 1xNO; CES 18.01 - Integrated auxiliary contact 1xNC



CES 18

Motor contactor CES 25; 42A(AC1); 25A/11kW(AC3, 400V)

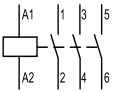

Type	Code No.	Wiring diagram	 g	
CES 25.00-24V-50/60Hz	004646541		410	1
CES 25.00-110V-50/60Hz	004646542		410	1
CES 25.00-230V-50/60Hz	004646543		410	1
CES 25.00-400V-50Hz	004646544		410	1
CES 25.00-24V DC	004646545		660	1
CES 25.00-42V-50/60Hz	004646546		410	1

Auxiliary contacts top or side mounted must be ordered separately



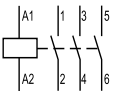

CES 25...32

Motor contactor CES 32; 42A(AC1); 32A/15kW(AC3, 400V)

Type	Code No.	Wiring diagram	 g	
CES 32.00-24V-50/60Hz	004646547		410	1
CES 32.00-110V-50/60Hz	004646548		410	1
CES 32.00-230V-50/60Hz	004646549		410	1
CES 32.00-400V-50Hz	004646550		410	1
CES 32.00-24V DC	004646551		660	1

Auxiliary contacts top or side mounted must be ordered separately

Motor contactor CES 40; 65A(AC1); 40A/18,5kW(AC3, 400V)

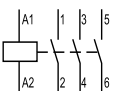

Type	Code No.	Wiring diagram	 g	
CES 40.00-24V-50/60Hz	004646552		670	1
CES 40.00-110V-50/60Hz	004646553		670	1
CES 40.00-230V-50/60Hz	004646554		670	1
CES 40.00-400V-50Hz	004646555		670	1

Auxiliary contacts top or side mounted must be ordered separately



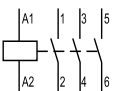

CES 40...45

Motor contactor CES 45; 65A(AC1); 45A/22kW(AC3, 400V)

Type	Code No.	Wiring diagram	 g	
CES 45.00-24V-50/60 Hz	004646556		640	1
CES 45.00-230V-50/60 Hz	004646557		640	1
CES 45.00-400V-50Hz	004646558		640	1
CES 45.00-110V-50/60 Hz	004646559		640	1

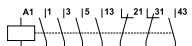
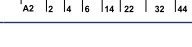

Auxiliary contacts top or side mounted must be ordered separately

Motor contactor CES 65; 90A(AC1); 65A/30kW(AC3, 400V)

Type	Code No.	Wiring diagram	 g	
CES 65.22-230V-50/60Hz	004646560		1.625	1
CES 65.22-24V-50/60Hz	004646561		1.625	1



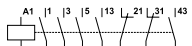
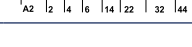

Included side mounted auxiliary contacts 2xNO+2xNC

Motor contactor CES 75; 100A(AC1); 75A/37kW(AC3, 400V)

Type	Code No.	Wiring diagram	 g	
CES 75.22-24V-50/60 Hz	004646562		2.530	1
CES 75.22-230V-50/60 Hz	004646563		2.530	1

Included side mounted auxiliary contacts 2xNO+2xNC

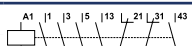
Motor contactor CES 85; 120A(AC1); 85A/45kW(AC3, 400V)





Type	Code No.	Wiring diagram	 g	
CES 85.22-24V-50/60 Hz	004646564		2.530	1
CES 85.22-230V-50/60 Hz	004646565		2.530	1

Included side mounted auxiliary contacts 2xNO+2xNC

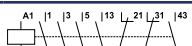

CES 65...105

Motor contactor CES 105; 120A(AC1); 105A/55kW(AC3, 400V)



Type	Code No.	Wiring diagram	 g	
CES 105.22-230V-50/60Hz	004646566		3.758	1
CES 105.22-24V-50/60Hz	004646567		3.758	1

Included side mounted auxiliary contacts 2xNO+2xNC



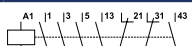

CES 140

Motor contactor CES 140; 160A(AC1); 140A/75kW(AC3, 400V)

Type	Code No.	Wiring diagram	 g	
CES 140.22-230V-50/60Hz	004646568		3.300	1

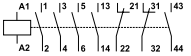

Included side mounted auxiliary contacts 2xNO+2xNC

Motor contactor CES 170; 210A(AC1); 170A/90kW(AC3, 400V)

Type	Code No.	Wiring diagram		
CES 170.22-230V-50/60Hz	004646569		4.800	1

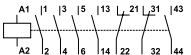

Included side mounted auxiliary contacts 2xNO+2xNC

Motor contactor CES 205; 220A(AC1); 205A/110kW(AC3, 400V)

Type	Code No.	Wiring diagram		
CES 205.22-230V-50/60Hz	004646570		4.800	1

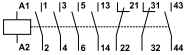

Included side mounted auxiliary contacts 2xNO+2xNC

Motor contactor CES 250; 300A(AC1); 250A/132kW(AC3, 400V)

Type	Code No.	Wiring diagram		
CES 250.22-230V-50/60Hz	004646571		6.200	1

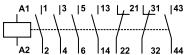

Included side mounted auxiliary contacts 2xNO+2xNC

Motor contactor CES 300; 320A(AC1); 300A/160kW(AC3, 400V)

Type	Code No.	Wiring diagram		
CES 300.22-230V-50/60Hz	004646572		6.200	1

Included side mounted auxiliary contacts 2xNO+2xNC

Motor contactor CES 400; 500A(AC1); 400A/200kW(AC3, 400V)

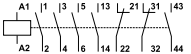
Type	Code No.	Wiring diagram		
CES 400.22-230V-50/60Hz	004646573		6.800	1

Included side mounted auxiliary contacts 2xNO+2xNC



CES 170...205



CES 250...300



CES 400

Mounting position

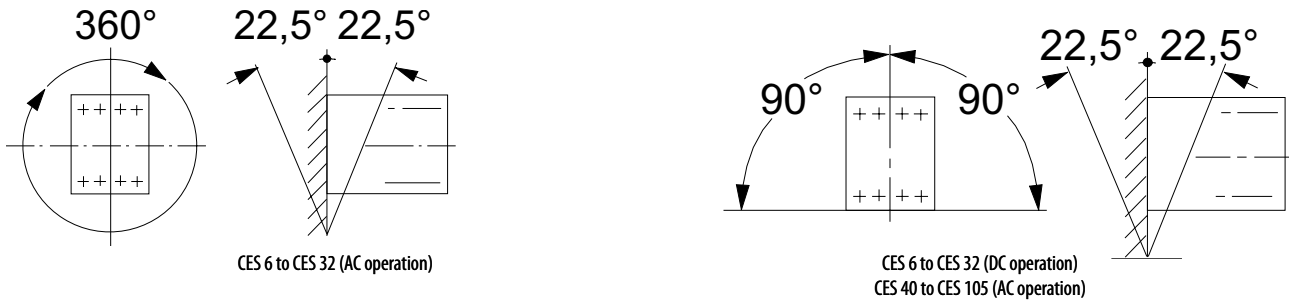

CES 6 ... CES 45

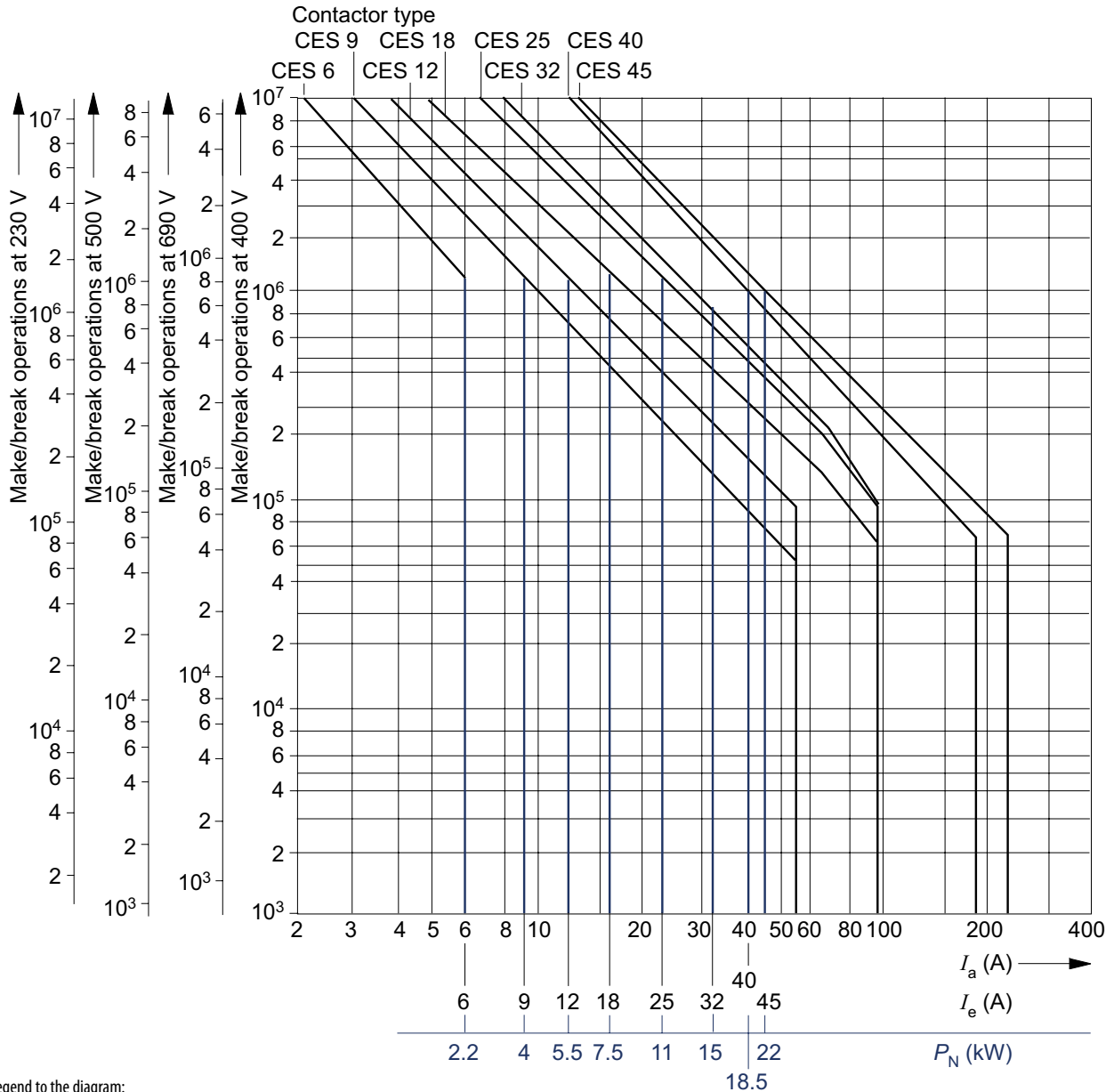

Legend to the diagram:

P_N = Rated output of three-phases motors with squirrel-cage at 400 V

I_a = Breaking current

I_e = Rated operational current

CES contactors

CES 65 ... CES 105

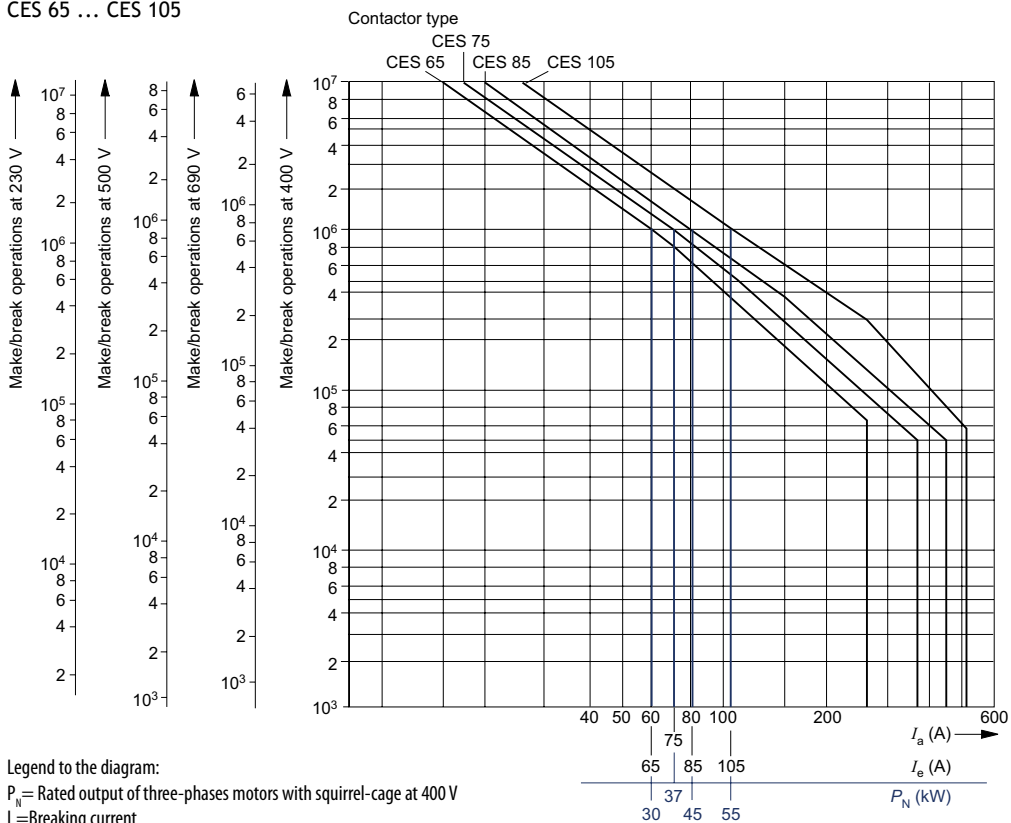

Legend to the diagram:

P_N = Rated output of three-phases motors with squirrel-cage at 400 V

I_a = Breaking current

I_e = Rated operational current

CES 65 ... CES 400

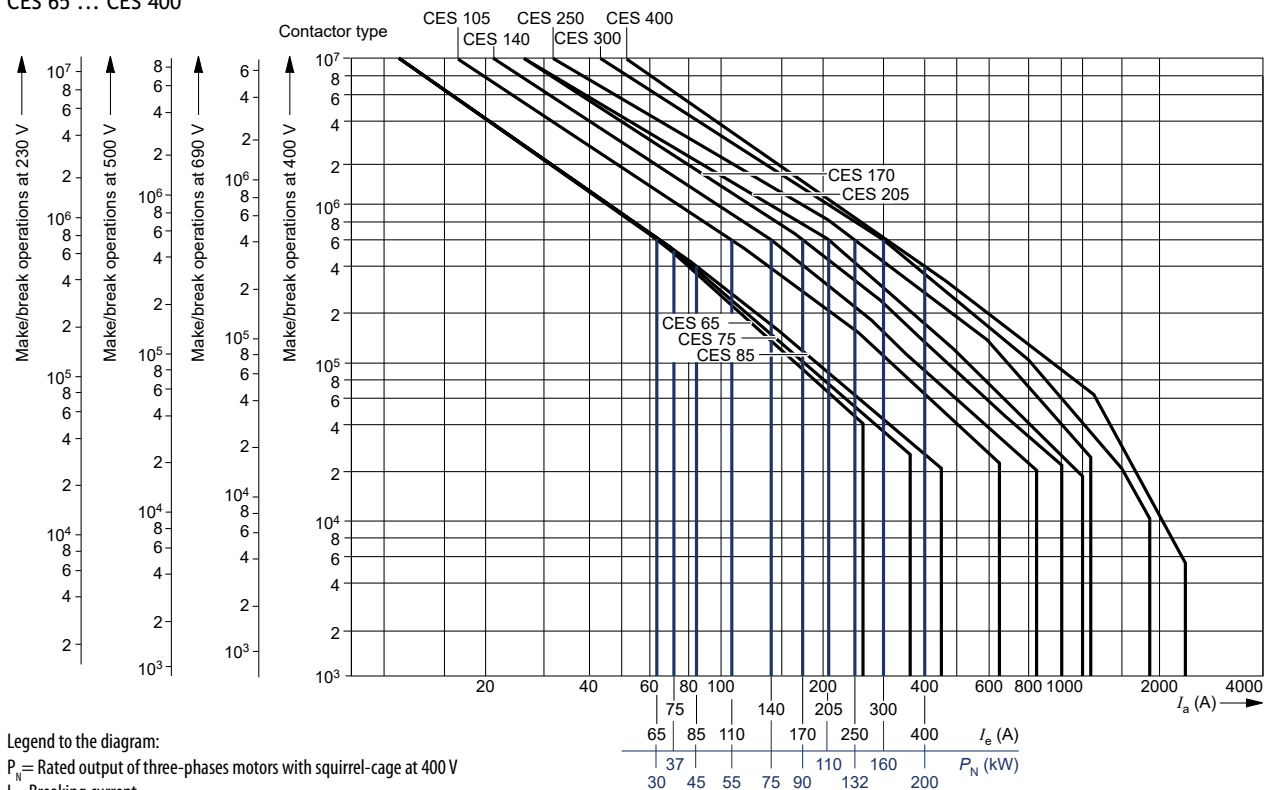

Legend to the diagram:

P_N = Rated output of three-phases motors with squirrel-cage at 400 V

I_a = Breaking current

I_e = Rated operational current



Technical data

Contactor		Type	CES 6 ... CES 18		CES 25, CES 32	
General data						
Mechanical endurance	Basic units	Operating cycles			15 Mio	
	Auxiliary contact blocks				10 Mio	
Rated insulation voltage U_i (pollution degree 3)		V			690	
Rated impulse withstand voltage U_{imp}		kV			8	
Protective separation ¹⁾ between coil and main contacts		V	≤ 500			≤ 690
Permissible ambient temperature ²⁾		°C	-25 to +55 in operation, -50 to +80 when stored			
Degree of protection		acc. to IEC 60947-1			IP 20	
Power consumption of the coils			(with cold coil) and 1.0 x U_s			
AC operation		Hz			50/60	
	closing	VA			77/71	
	cos φ				0.81/0.75	
	closed	VA			11/9	
	cos φ				0.28/0.27	
DC operation	closing = closed	W			6.2	
Permissible residual current of the electronics (at 0-Signal)			< 8 mA × $\frac{-220V}{U_s}$ AC operation		< 1.25 mA × $\frac{-220V}{U_s}$ DC operation	
Coil voltage tolerance			0.8 ... 1.1 x U_s			
Operating times at 0.8 to 1.1 x U_s			Break time = opening time + arcing time (Values are applicable with the coil in cold state and at operating temperature)			
AC operation	closing time	ms	8 ... 35		10 ... 35	
	opening time	ms	4 ... 18		5 ... 20	
DC operation	closing time	ms	20 ... 170		35 ... 180	
	opening time	ms	10 ... 25		10 ... 25	
Arcing time		ms	10		10	
Operating times at 1.0 x U_s						
AC operation	closing time	ms	10 ... 25		10 ... 25	
	opening time	ms	5 ... 18		5 ... 20	
DC operation	closing time	ms	30 ... 70		40 ... 80	
	opening time	ms	12 ... 20		10 ... 20	
Shock resistance	Rectangular pulse	AC	g/ms 7.7/5 & 4.4/10		5.5/5 & 3.2/10	
		DC	g/ms 9.3/5 & 5.4/10		5.8/5 & 3.4/10	
	Sine pulse	AC	g/ms 12/5 & 6.8/10		8.7/5 & 5.1/10	
		DC	g/ms 14.7/5 & 8.5/10		9/5 & 5.3/10	
Conductor cross-sections (screw connection; 1 or 2 conductor connection possible)	Main conductor:					
	solid	mm ²	2 x (0.5 ... 1); 2 x (1 ... 2.5); 1 x 4		2 x (2.5 ... 6)	
	finely stranded with end sleeve	mm ²	2 x (0.5 ... 1); 2 x (0.75 ... 2.5)		2 x (0.5 ... 1); 2 x (1.5 ... 4)	
	Pin-end connector (DIN 46 231)	mm ²	1 x (1 ... 2.5)		1 x (1 ... 6)	
	solid or stranded	AWG	2 x (18 ... 12)		2 x (14 ... 10)	
	Terminal screw		M3.5		M4	
	Auxiliary conductor:					
	solid	mm ²	2 x (0.5 ... 1); 2 x (1 ... 2.5)		2 x (0.5 ... 1); 2 x (1 ... 2.4)	
	finely stranded with end sleeve	mm ²	2 x (0.5 ... 1); 2 x (0.75 ... 2.5)		2 x (0.5 ... 1); 2 x (0.75 ... 2.5)	
	Pin-end connector (DIN 46 231)	mm ²	2 x (1 ... 1.5)		2 x (1 ... 1.5)	
solid or stranded	AWG	2 x (18 ... 12)		2 x (18 ... 12)		
Specified tightening torque of the terminal screws	Main conductor:		0.8 ... 1.4 Nm (7 ... 12 lb.in)		1 ... 1.5 Nm (8.8 ... 13 lb.in)	
	Auxiliary conductor		0.8 ... 1.4 Nm (7 ... 12 lb.in)		0.8 ... 1.4 Nm (7 ... 12 lb.in)	
Operating frequency z in operating cycles per hour (o.c./h)			Operation:		Operation:	
Contactors without overload relay	No-load operating frequency	1/h	10000	1500	5000	1500
	Rated duty at AC-1	1/h	1500	1500	1500	1500
	at AC-2 and AC-3	1/h	1000	1000	750	750
	at AC-4	1/h	250	250	250	250
Contactor with overload relay (mean value)		1/h	15		15	

1) Acc. to IEC 60947-1, Annex N.

2) When CES 6 to CES 32 AC operated contactors are mounted in rows, the minimum gap between them must be 5 mm when the coil voltage is 1.1 x U_s , the ambient temperature ≥ 45 °C and the load factor of all relays is 100 %.

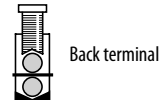

Technical data

Contactor		Type	CES 40		CES 45		
General data							
Mechanical endurance	Basic units		Operating cycles	10 Mio			
	Auxiliary contact blocks			10 Mio			
Rated insulation voltage U_i (pollution degree 3)			V	690			
Rated impulse withstand voltage U_{imp}			kV	8			
Protective separation ¹⁾ between coil and main contacts			V	≤ 415			
Permissible ambient temperature			°C	-25 to +55 in operation, -50 to +80 when stored			
Degree of protection		acc. to IEC 60947-1		IP 00			
Power consumption of the coils			(with cold coil) and 1.0 x U_s				
AC operation			Hz	50/60			
	closing		VA	121/117			
	p.f.			0.79/0.72			
	closed		VA	16.5/13			
	p.f.			0.27/0.28			
Coil voltage tolerance			0.8 ... 1.1 x U_s				
Operating times at 0.8 to 1.1 x U_s Break time = opening time + arcing time							
AC operation ²⁾	closing time		ms	13 ... 57			
	opening time		ms	5 ... 10			
Arcing time			ms	10			
Operating times at 1.0 x U_s							
AC operation ²⁾	closing time		ms	13 ... 32			
	opening time		ms	5 ... 10			
Shock resistance	Rectangular pulse	AC	g/ms	5.7/5 & 3.3/10			
		DC	g/ms	5.7/5 & 3.3/10			
	Sine pulse	AC	g/ms	9/5 & 5.2/10			
		DC	g/ms	9/5 & 5.2/10			
Conductor cross-selections (screw connection; 1 or 2 conductor connection possible)	Main conductor:			Front terminal connected	Back terminal connected	Both terminal connected	
							
	solid		mm ²	1 ... 16	1 ... 16	1 ... 16	1 ... 16
	finely stranded without end sleeve		mm ²	2.5 ... 16	1.5 ... 16	2.5 ... 10	1.5 ... 16
	finely stranded with end sleeve		mm ²	1 ... 16	1 ... 16	1 ... 10	1 ... 16
	standed		mm ²	2.5 ... 25	1.5 ... 25	2.5 ... 10	1.5 ... 25
	Pin-end connector (DIN 46 231)		mm ²	1 ... 6	1 ... 6	1 ... 6	1 ... 6
	solid or stranded		AWG	14 ... 3	16 ... 3	14 ... 6	16 ... 3
	Terminal screw			M5	M5	M5	M5
	Auxiliary conductor:						
	solid		mm ²	2 x (0.5 ... 1); 2 x (1 ... 2.5)			
	finely stranded with end sleeve		mm ²	2 x (0.5 ... 1); 2 x (0.75 ... 2.5)			
	Pin-end connector (DIN 46 231)		mm ²	2 x (1 ... 1.5)			
	solid or stranded		AWG	2 x (18 ... 12)			
Specified tightening torque of the terminal screws	Main conductor:		2.5 ... 3.0 Nm (22 ... 26.5 lb.in)				
	Auxiliary conductor		0.8 ... 1.4 Nm (7 ... 12 lb.in)				
Operating frequency z in operating cycles per hour (o.c./h)			Operation:		Operation:		
Contactors without overload relay	No-load operating frequency		1/h	AC	DC	AC	DC
	Rated duty at AC-1		1/h	5000	on request	5000	on request
	at AC-2		1/h	1200	1200	1200	1200
	at AC-3		1/h	600	600	600	600
	at AC-4		1/h	600	600	600	600
Contactor with overload relay (mean value)			1/h	15	250	200	600

1) Acc. to IEC 60947-4-1, Annex N.

2) The opening time delay of the NO contacts and the closing time of the NC contacts are increased when the contactor coil is protected against voltage peaks (diode 6 to 9 times; diode combination 2 to 6 times, varistor + 2 to 5 ms).

Technical data

Contactor	Type	CES 65	CES 75	CES 85	CES 105		
General data							
Mechanical endurance	Operating cycles	10 million (AC operation)					
Rated insulation voltage U_i (pollution degree 3)	V	1000					
Rated impulse withstand voltage U_{imp}	kV	8					
Protective separation ¹⁾ between coil and main contacts	V	≤ 500		≤ 690			
Permissible ambient temperature	°C	-25 to +55 in operation, -50 to +80 when stored					
Degree of protection	acc. to IEC 60947-1	IP 00/oper type, operating mechanism IP40					
Power consumption of the coils		(with cold coil) and 1.0 x U_s					
	Hz	50/60					
AC operation	closing	VA	225/192	398/345			
	p.f.		0.6/0.54	0.5/0.4			
	closed	VA	24/16	46/29			
	p.f.		0.29/0.29	0.23/0.24			
Coil voltage tolerance		0.8 ... 1.1 x U_s					
Operating times at 0.8 to 1.1 x U_s Break time = opening time + arcing time							
AC operation ²⁾	closing time	ms	15 ... 40	20 ... 50			
	opening time	ms	5 ... 25	5 ... 30			
Arcing time	ms	10 ... 15					
Operating times at 1.0 x U_s							
AC operation ²⁾	closing time	ms	17 ... 30	22 ... 35			
	opening time	ms	5 ... 25	5 ... 30			
Shock resistance	Rectangular pulse	AC	11.2/5 & 6/10		8.4/5 & 4.8/10		
		DC	10.7/5 & 6.2/10 (14.5 & 7.7/10)1)		8.3/5 & 4.75/10		
	Sine pulse	AC	17.6/5 & 10.3/10		13.2/5 & 7.5/10		
		DC	16.8/5 & 9.7/10 (22/5 & 12/10)1)		13/5 & 7.4/10		
Conductor cross-sections (screw connection; 1 or 2 conductor connection possible)	Main conductor: - with box terminal		Front terminal connected	Back terminal connected	Both terminal connected		
					Front terminal		Back terminal
		solid	mm ²	6 ... 16	1 ... 16	1 ... 16	1 ... 16
		finely stranded without end sleeve	mm ²	10 ... 35	1.5 ... 16	1.5 ... 16	1.5 ... 16
		finely stranded with end sleeve	mm ²	6 ... 35	1 ... 16	1 ... 16	1 ... 16
		standed	mm ²	16 ... 50	1.5 ... 25	1.5 ... 25	1.5 ... 25
	solid or stranded	mm ²	10 ... 1/0	16 ... 3	16 ... 3	16 ... 3	
		Terminal screw		M6			
		Tightening torque - without box terminal		4 ... 6 Nm (36 ... 52 lb. in)			
		finely stranded with cable lug	mm ²	10 ... 352)			
		standed with cable lug	mm ²	10 ... 502)			
		solid or stranded	AWG	7 ... 1/0			
		Terminal bar (max. width)	mm	12			
		Terminal screw		M6 x 20			
		Tightening torque		4 ... 6 Nm (36 ... 52 lb. in)			
	Auxiliary conductor:						
	solid	mm ²	2 x (0.5 ... 1); 2 x (1 ... 2.5); 1 x 4				
	finely stranded with end sleeve	mm ²	2 x (0.5 ... 1); 2 x (0.75 ... 2.5)				
	Pin-end connector (DIN 46 231)	mm ²	2 x (1 ... 1.5)				
	solid or stranded	AWG	2 x (18 ... 12)				
	Tightening torque	mm ²	0.8 ... 1.4 Nm (7 ... 12 lb. in)				

1) In accordance with IEC 60947-1, Annex N.

2) The opening time delay of the NO contacts and the closing time of the NC contacts are increased when the contactor coil is protected against voltage peaks (diode 6 to 9 times; diode combination 2 to 6 times, varistor + 2 to 5 ms).

Technical data

Contactors			Type	CES 140	CES 170	CES 205	CES 250	CES 300	CES 400	
Rated power AC-3, 400V			KW	75	90	110	132	160	200	
Rated operational current I_e at 400V,	40° C AC-1	40° C AC-1	A	160	210	220	300	320	500	
	AC-3	AC-3	A	140	170	205	250	300	400	
at 400V,	AC-4	AC-4	A	68	75	96	110	125	150	
	400V, +40° C		A	160	210	220	300	300	400	
Conventional thermal current I_{th}										
Ambient Temperature	Operation		°C	-25 ... +55						
	Storage		°C	-25 ... +70						
Humidity				+40°C no more than 50%, +25°C no more than 90%						
Altitude without derating			m	≤2000						
Mechanical Life			mil. cycles	4	4	4	4	4	4	
Electrical Life			mil. cycles	0,6	0,6	0,6	0,6	0,6	0,4	
Max. Operating Frequency without overload relay	at AC-3	at AC-3	cycles/hr.	1200	600	600	600	600	600	
	at AC-4	at AC-4	cycles/hr.							
Rated insulation voltage U_i			V	1000	1000	1000	1000	1000	1000	
Rated impulse withstand voltage U_{imp}			kV	8	8	8	8	8	8	
Power consumption of the coils	AC operation	Closing	VA	550	910	910	1430	1430	2450	
		Cos φ		0,45	0,38	0,38	0,34	0,34	0,21	
		Closed	VA	39	58	58	84	84	115	
		Cos φ		0,24	0,26	0,26	0,24	0,24	0,33	
Coil type				AC 50/60Hz 24V, 110V, 220V, 380V						
Operating range of coil			at U_s AC	x U_s	0.8-1.1	0.8-1.1	0.8-1.1	0.8-1.1	0.8-1.1	0.8-1.1
AC operation at $1xU_s$	Opening		ms	8...30	8...30	8...30	8...30	8...30	8...20	
	Closing		ms	20...50	20...50	20...50	20...50	20...50	17...65	
Conductor cross-selections (screw connection; 1 or 2 conductor connection possible)	Main conductor:									
	finely stranded with cable lug		mm ²	35 ... 95			50 ... 240			
	stranded with cable lug		mm ²	50 ... 120			70 ... 240			
	solid or stranded		AWG	1/0 ... 250 MCM			2/0 ... 500 MCM			
	Terminal bar (max. with)		mm	20 x 3			25 x 3			
Terminal screw			M8 x 25			M10 x 30				
Tightening torque		Nm	10 ... 14			14 ... 24				
Degrees of Protection				IP00						
Short circuit protection without overload relay			Coordination type 2	A	225	315	315	355	450	460
Auxiliary switch block pre- mounted in side	1NO+1NC			√	√	√	√	√	√	
	2NO+2NC			√	√	√	√	√	√	
	4NO+4NC			√	√	√	√	√	√	
Auxiliary switch block in addition - Top mounted			NO/NC	x						
Auxiliary switch block	Rated insulation voltage U_i		V	690						
	Rated impulse withstand voltage U_{imp}		kV	6						
	Rated current capacity			AC-15: 360VA; DC-13 33W						
	Conventional thermal current I_{th}		A	10						
Dimensions (AC - Operation) H / B; Width			mm	≤120 mm	≤ 135mm	≤ 145mm	≤ 160mm			
Mounting				Screw mounted, Vertical +/- 22.5°C						
Main circuit Terminal screw type				Busbar - Hex head						
Certificates & Standards				CE, RoHS						

Technical data

Contactor	Type		CES 6	CES 9	CES 12	CES 18	CES 25	CES 32	
Load ratings of the contactors with AC									
Thermal load	10 s current ¹⁾		A	90	90	96	96	176	176
Power loss per conducting path	at I _e /AC-3		W	0.6	0.6	1.1	1.1	1.6	1.6
AC-1 duty, switching resistive load ²⁾									
Rated operational currents I _e	at 40 °C to	690 V	A	25	25	25	25	38	38
	at 55 °C to	690 V	A	20	20	20	20	32	32
Minimum conductor cross-section at I _e load	at 40 °C		mm ²	4	4	4	4	10	10
	at 55 °C		mm ²	4	4	4	4	10	10
AC-2 and AC-3 duty									
Rated operational currents I _e	up to	400 V	A	6	9	12	18	25	32
		500 V	A	6	9	12	16	17	32
		690 V	A	6	6.6	8.8	12.2	12.2	27
Max. rating of slipring or squirrel-cage motors at 50 and 60 Hz	at	230 V	kW	1.5	2.4	3.3	4	5.5	8.5
		400 V	kW	2.2	4	5.5	7.5	11	15
		500 V	kW	3	5.5	7.5	9	11	21
		690 V	kW	4	5.5	7.5	11	11	23
AC-4 duty (contact endurance approx. 200.000 operating cycles I _a = 6 x I _e)									
Rated operational currents I _e	up to	400 V	A	3.1	3.3	4.3	7.7	8.5	15.6
		690 V	A	3.1	3.3	4.3	7.7	8.5	15.6
Ratings of squirrel-cage motors at 50 and 60 Hz	at	230 V	kW	0.8	0.85	1.15	2	2.2	4.3
Max. permitted rated operational current I _e /AC-4 = ^ I _e /AC-3 up to 500 V with endurance and operating frequency		400 V	kW	1.15	1.4	1.9	3.5	4	7.5
		690 V	kW	1.9	2.4	3.3	6	6.6	13
Contactor									
		Type	CES 40	CES 45	CES 65	CES 75	CES 85	CES 105	
Load ratings of the contactors with AC									
Thermal load	10 s current ¹⁾		A	400	400	360	500	800	800
Power loss per conducting path	at I _e /AC-3		W	2.0	2.5	3.5	6	7.5	10
AC-1 duty, switching resistive load ²⁾									
Rated operational currents I _e	at 40 °C to	690 V	A	65	65	90	100	105	105
	at 55 °C to	690 V	A	55	55	80	90	100	105
Minimum conductor cross-section at I _e load	at 40 °C		mm ²	16	16	35	35	50	50
	at 55 °C		mm ²	16	16	25	35	35	35
AC-2 and AC-3 duty									
Rated operational currents I _e	up to	400 V	A	40	45	65	75	85	105
		500 V	A	32	38	40	63	75	85
		690 V	A	27	27	40	63	75	75
		1000 V	A	--	--	6	6	30	30
Max. rating of slipring or squirrel-cage motors at 50 and 60 Hz	at	230 V	kW	11	15	18.5	22	26	37
		400 V	kW	18.5	22	30	37	45	55
		500 V	kW	21	25	30	41	50	59
		690 V	kW	23	23	39	56	67	67
		1000 V	A	--	--	--	--	39	39
AC-4 duty (contact endurance approx. 200.000 operating cycles I _a = 6 x I _e)									
Rated operational currents I _e	up to	400 V	A	18.5	24	28	34	42	54
		690 V	A	18.5	24	28	34	42	54
		1000 V	A	--	--	--	23	23	34
Ratings of squirrel-cage motors at 50 and 60 Hz	at	230 V	kW	5.2	7.3	8.5	10.3	12	16.3
Max. permitted rated operational current I _e /AC-4 = ^ I _e /AC-3 up to 500 V with endurance and operating frequency		400 V	kW	9	12.6	14.7	17.9	22	28.4
		690 V	kW	15.5	20.8	24.3	29.5	38	49
		1000 V	kW	--	--	--	30	30	45

1) Acc. to IEC 60947-4-1.

2) Industrial furnaces and electric heaters with resistance heating for example (higher current during heating-up allowed for).

Technical data

Contactor	Type		CES 140	CES 170	CES 205	CES 250	CES 300	CES 400	
Load ratings of the contactors with AC									
Thermal load	10 s current ¹⁾		A	1140	1360	1640	2500	2500	3400
Power loss per conducting path	at I _e /AC-3		W	14	14	20	16	23	40
AC-1 duty, switching resistive load ²⁾									
Rated operational currents I _e	at 40 °C to	690 V	A	170	230	240	325	325	425
	at 55 °C to	690 V	A	160	210	220	300	300	400
Minimum conductor cross-section at I _e load	at 40 °C		mm ²	70	120	120	185	185	2x150
	at 55 °C		mm ²	70	95	120	185	185	240
AC-2 and AC-3 duty									
Rated operational currents I _e	up to	500 V	A	140	170	205	250	300	400
		690 V	A	110	170	170	250	250	400
		1000 V	A	42	68	68	95	95	180
Max. rating of slipping or squirrel-cage motors at 50 and 60 Hz	at	230 V	kW	45	56	66	82	96	131
		400 V	kW	75	95	115	142	168	232
		500 V	kW	98	118	145	178	210	289
		690 V	kW	105	163	163	245	245	397
		1000 V	A	65	90	90	132	132	250
AC-4 duty (contact endurance approx. 200.000 operating cycles I _a = 6 x I _e)									
Rated operational currents I _e	up to	690 V	A	68	75	96	110	125	150
		1000 V	A	34	42	42	57	57	80
Ratings of squirrel-cage motors at 50 and 60 Hz	at	230 V	kW	21	23	30	35	40	49
		400 V	kW	36	40	52	61	69	85
Max. permitted rated operational current I _e /AC-4 = I _e /AC-3 up to 500 V with endurance and operating frequency	at	690 V	kW	63	69	90	105	119	147
		1000 V	kW	45	55	55	75	75	110

Dimensional drawings

AC operation

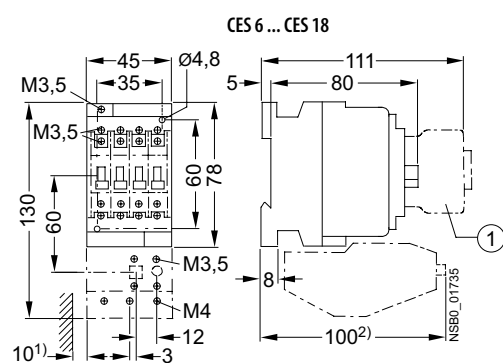

① Auxiliary switch block

- 1) Minimum clearance from the earthed parts.
- 2) Dimension for the square OFF-button (stroke 3 mm).
Dimension for the round RESET-button (stroke 2.5 mm) less than 2.5 mm.

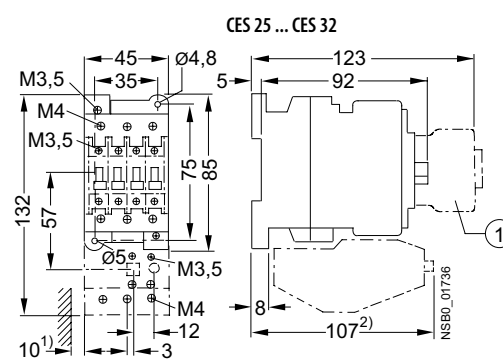

① Auxiliary switch block

- 1) Minimum clearance from the earthed parts.
- 2) Dimension for the square OFF-button (stroke 3 mm).
Dimension for the round RESET-button (stroke 2.5 mm) less than 2.5 mm.

DC operation

CES 6 ... CES 18

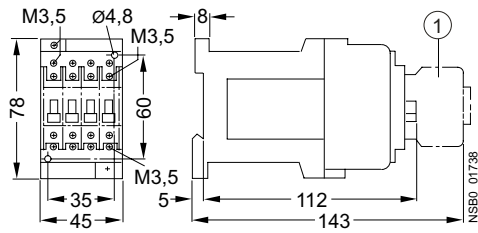

① Auxiliary switch block

CES 25 ... CES 32

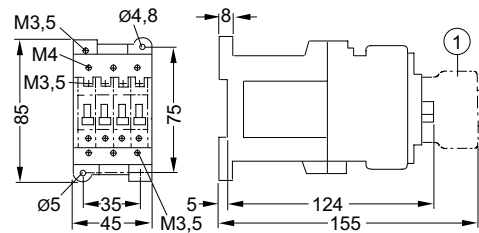

① Auxiliary switch block

• Clearance when mounted in rows:

When CES 6 to CES 32 AC operated contactors are mounted in rows, the minimum gap between them must be 5 mm when the coil voltage $1.1 \times$ the ambient temperature $\geq 45^\circ\text{C}$ and the load factor of all relays is 100 %.

CES 40 ... CES 45

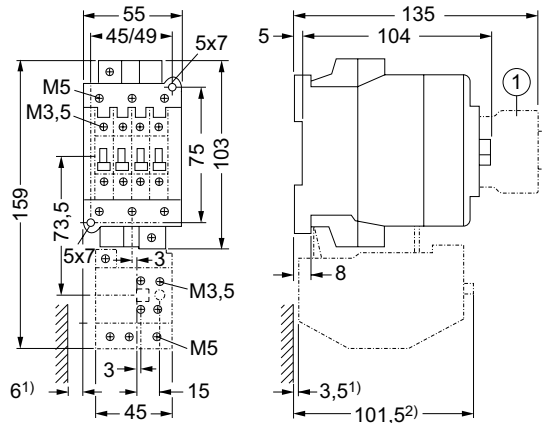

① Auxiliary switch block

- 1) Minimum clearance from the earthed parts.
- 2) Dimension for the square OFF-button (stroke 3 mm).
Dimension for the round RESET-button (stroke 2.5 mm) less than 2.5 mm.

CES 65 ... CES 140

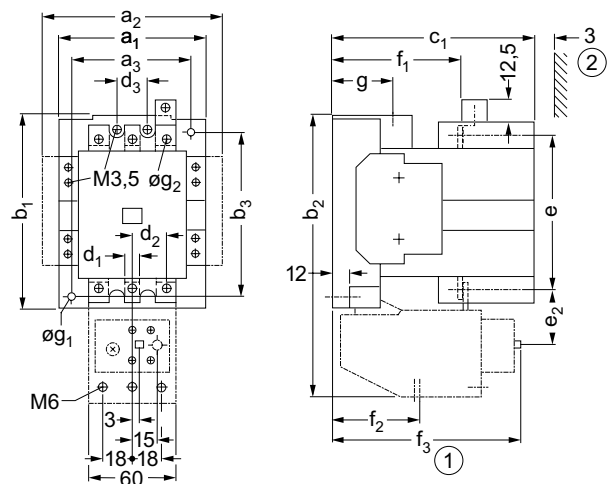

- ① Dimension for the square OFF-button (stroke 3 mm)
Dimension for the round RESET-button (stroke 2.5 mm) less than 2.5 mm.
- ② Minimum clearance from insulated components 3 mm
Minimum clearance from earthed components 10 mm

	a1	a2	a3	b1	b2	b3	c1	d1	d2	d3	e	e2	f1	f2	f3	g1	g2
CES 65	90	113	70	117	175	100	123	8	26.5	25	94	80	63	122	28	4.8	6.1 (M6)
CES 75																	
CES 85	100	123	80	133	194	110	140	8	26.5	25	107	89	63	122	39	5.5	6.1 (M6)
CES 105	100	123	80	133	194	110	140	10.5	26.5	25	116	89	63	122	39	5.5	6.1 (M6)
CES 140	120	143	100	150	232	130	150	20	42	37	139	40.5	93	80	146	6.3	9 (M)

CES 170 ... CES 205

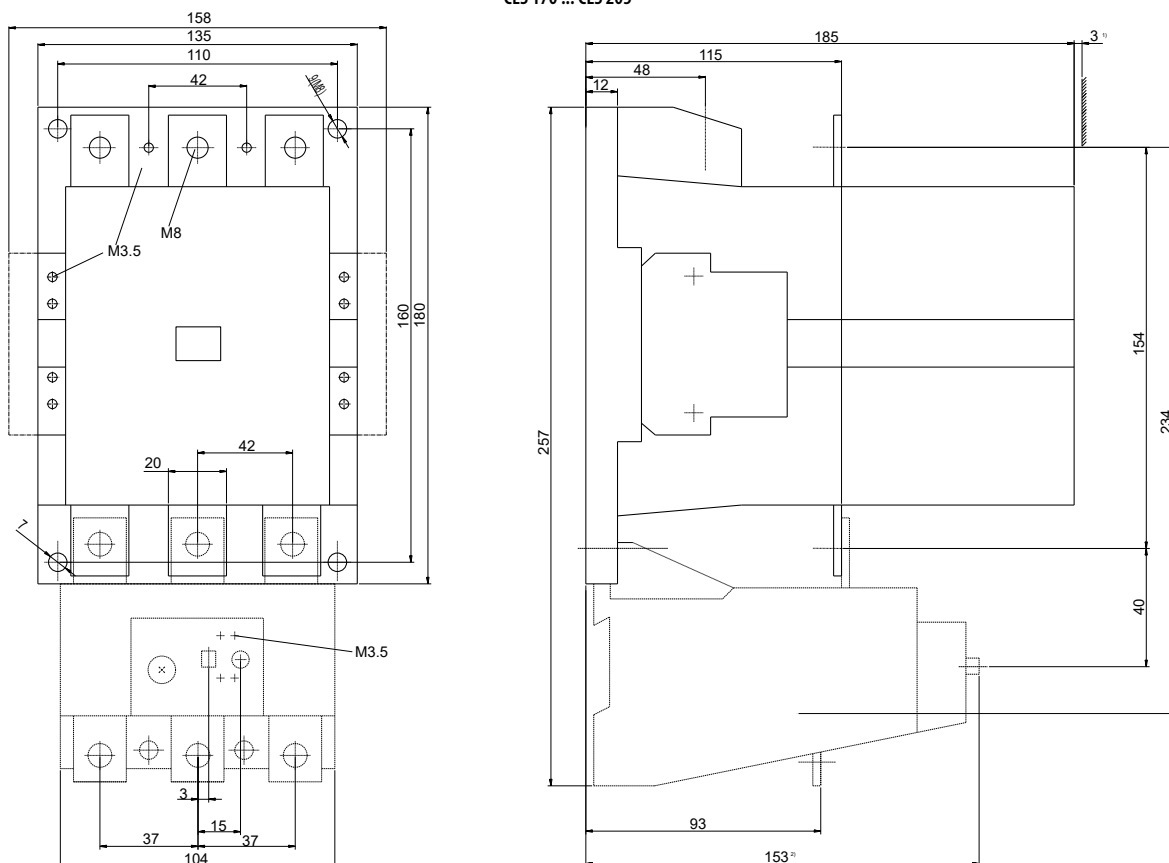

- 1) Minimum clearance from insulated components: 3mm.
Minimum clearance from earth components: 3mm.
- 2) Dimension for the quere OFF-button(stroke 3mm).
Dimension for the round RESET-button(Stroke 2.5mm) less 2.5mm.

CES 250 ... CES 400

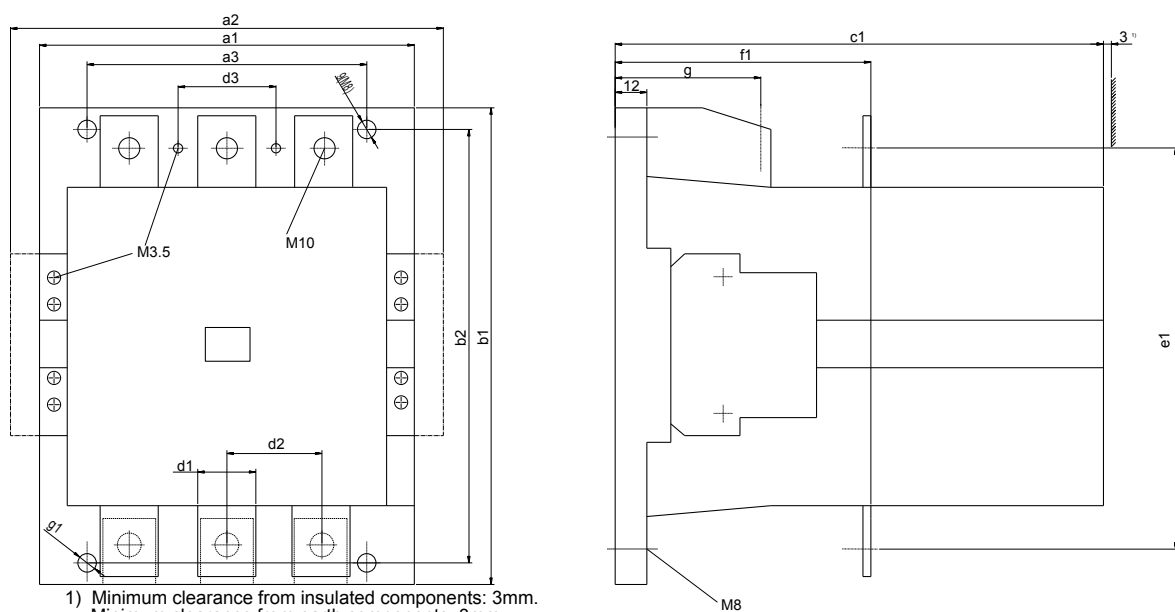





- 1) Minimum clearance from insulated components: 3mm.
Minimum clearance from earth components: 3mm.
- 2) Dimension for the quere OFF-button(stroke 3mm).
Dimension for the round RESET-button(Stroke 2.5mm) less 2.5mm.

	a1	a2	a3	b1	b2	c1	d1	d2	d3	(c1)1	e1	f1	g	g1
CES 250 - CES 300	145	168	120	200	180	198	25	48	48	198	168	132	58	9
CES 400	160	183	130	200	180	222	25	48	48	222	178	150	65	9

	AC operation for 0.8...1.1U _n		DC operation for 0.85...1.1U _n		Arcing time
	opening delay	closing delay	opening delay	closing delay	
CES 6	5 ... 25	8 ... 35	10 ... 25	20 ... 170	10
CES 9	5 ... 25	8 ... 35	10 ... 25	20 ... 170	10
CES 12	5 ... 25	8 ... 35	10 ... 25	20 ... 170	10
CES 18	5 ... 25	8 ... 35	10 ... 25	20 ... 170	10
CES 25	5 ... 25	10 ... 35	10 ... 25	35 ... 180	10
CES 32	5 ... 25	10 ... 35	10 ... 25	35 ... 180	10
CES 40	5 ... 25	13 ... 57	13 ... 17	54 ... 182	10
CES 45	5 ... 25	13 ... 57	13 ... 17	54 ... 182	10
CES 65	5 ... 25	15 ... 40	100 ... 120	15 ... 88	10 ... 15
CES 75	5 ... 25	15 ... 40	100 ... 120	15 ... 88	10 ... 15
CES 85	5 ... 30	20 ... 50	90 ... 140	20 ... 90	10 ... 15
CES 105	5 ... 30	20 ... 50	90 ... 140	20 ... 90	10 ... 15
CES 140	8 ... 30	20 ... 50	-	-	10 ... 15
CES 170	8 ... 30	20 ... 50	-	-	10 ... 15
CES 205	8 ... 30	20 ... 50	-	-	10 ... 15
CES 250	8 ... 30	20 ... 50	-	-	10 ... 15
CES 300	8 ... 30	20 ... 50	-	-	10 ... 15
CES 400	8 ... 20	17 ... 65	-	-	10 ... 15

Accessories

Auxiliary contact block - front mounted; 5,6A(230V, AC-15/AC-14), 3,8A(400V, AC-15/AC-14)





Type	Code No.	Description	For use with	Wiring diagram		
CES-BCF 10	004646574	1 NO	CES 6...CES 45		20	10
CES-BCF 01	004646575	1 NC	CES 6...CES 45		20	10

Up to max. 4 contacts



CES-BCF

Auxiliary contact block - lateral; 5,6A(230V, AC-15/AC-14), 3,8A(400V, AC-15/AC-14)

Type	Code No.	Description	For use with	Wiring diagram		
CES-BCSU 11	004646576	1 NO + 1 NC	CES65...CES 400		52	2
CES-BCSS 11	004646577	1 NO + 1 NC	CES65...CES 400		42	2

Up to max. 4 contacts, 2 per each side

BCSU - upgrade contact with screws

BCSS - spare part only, no mounting screws

Possible to order only multiples of 2pcs (2, 4, 6, 8...) due to the default packaging system



CES-BCSU 11



CES-BCSS 11

Auxiliary contacts for CES contactors Technical Data

Type		CES 6 ... CES 32 ¹⁾	CES 6 ... CES 18 ²⁾	CES 40, CES 45 ¹⁾	CES 65 ... CES 400
Rated insulation voltage U_i (pollution degree 3)	V	690	690	690	1000
Conventional free-air thermal current I_{th} = rated operational current I_e	A	10	10	10	10
AC duty Rated operational current I_c /AC-15/AC-14 at rated operational voltage U_e	24 V	A 6	10	10	10
	110 V	A 6	10	10	10
	125 V	A 6	10	10	10
	220 V	A 6	10	6	6
	230 V	A 5,6	9,6	5,6	5,6
	380 V	A 4	6	4	4
	400 V	A 3,8	5,5	3,6	3,6
	500 V	A 2,5	4	2,5	2,5
	660 V	A 2	2	2,5	2,5
DC duty Rated operational current I_c /DC-12 at rated operational voltage U_e	690 V	A 1,8	1,8	2,3	2,3
	24 V	A 10	10	--	--
	48 V	A 10	10	--	--
	110 V	A 5,5	2,1	--	--
	125 V	A --	--	--	--
	220 V	A 1,2	0,8	--	--
	440 V	A 0,28	0,6	--	--
Rated operational current I_c /DC-13 at rated operational voltage U_e	600 V	A 0,14	0,6	--	--
	24 V	A 10	10	--	--
	48 V	A 4,6	5	--	--
	110 V	A 0,8	0,9	--	--
	125 V	A --	--	--	--
	220 V	A 0,3	0,45	--	--
	440 V	A 0,11	0,25	--	--
600 V	A 0,08	0,2	--	--	



1) Mountable auxiliary contact blocks.

2) Integrated auxiliary contacts.

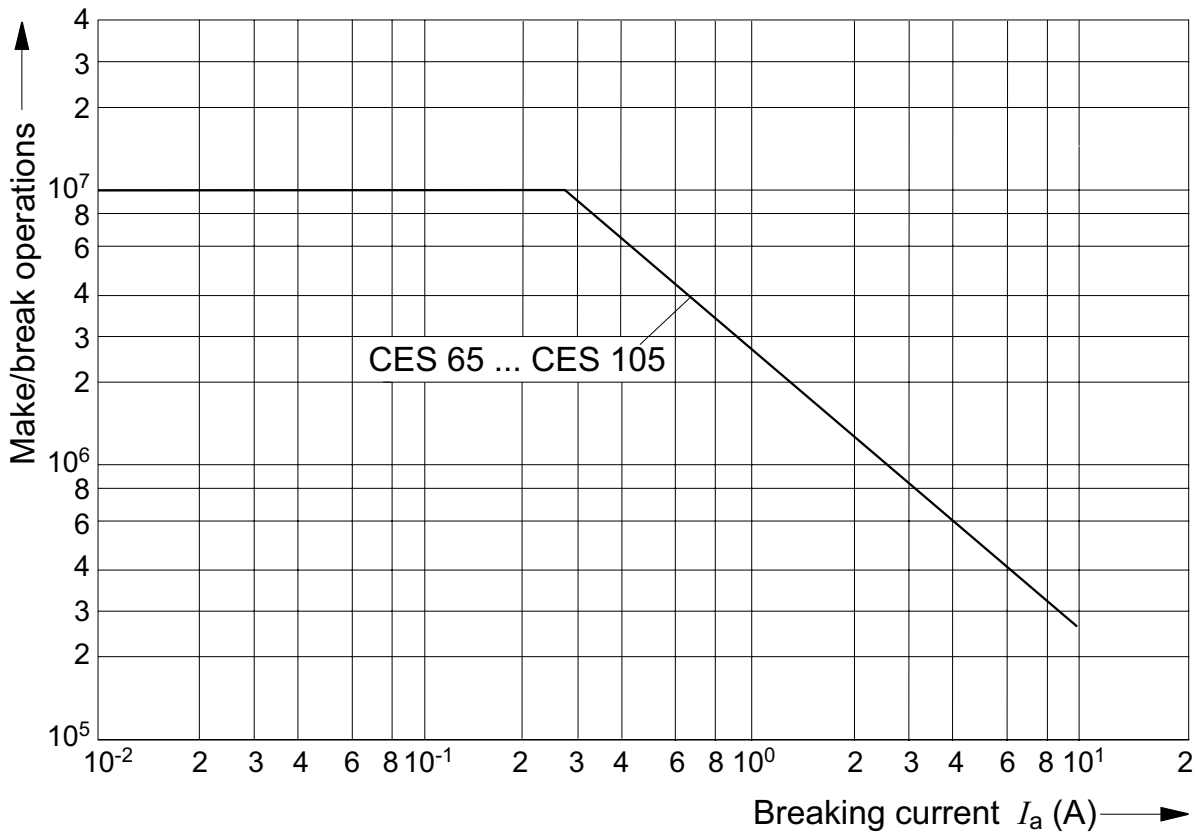
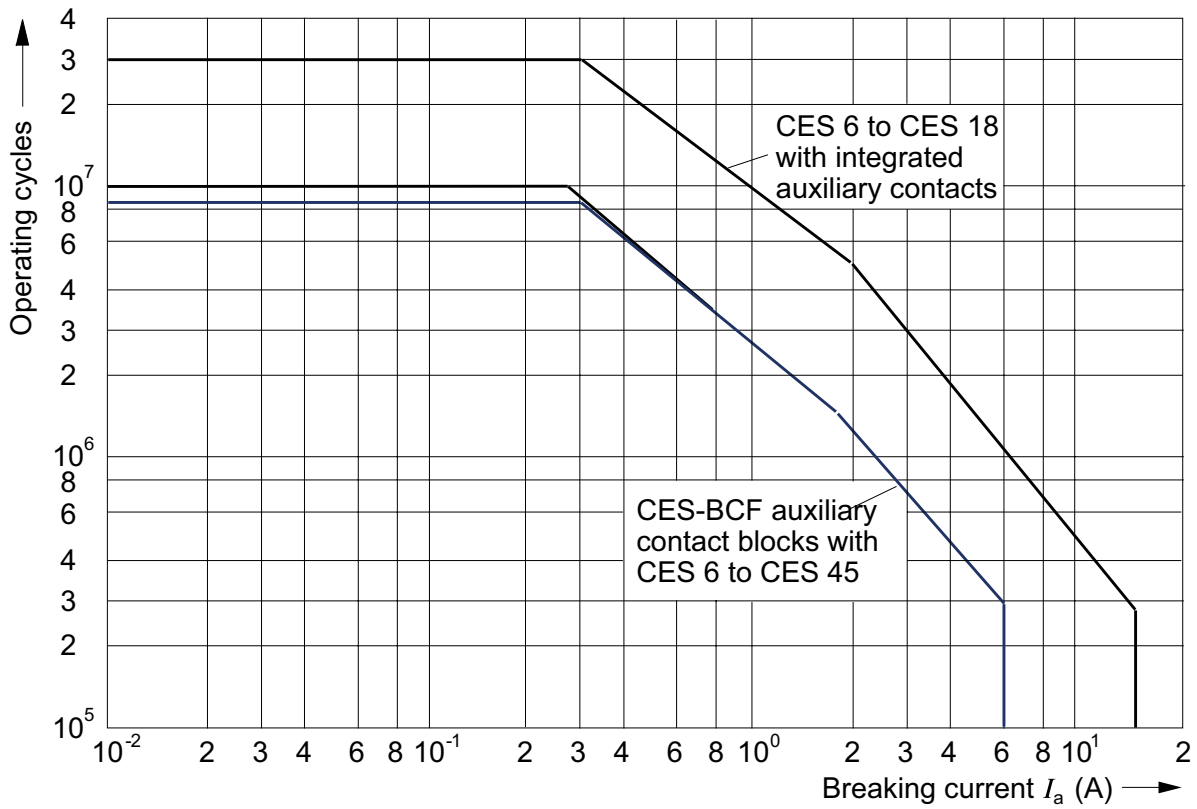
Contact endurance of the auxiliary contacts



Mechanical interlock for mechanical locking of contactors

Type	Code No.	For use with	 g	
CES-MIL 6-45	004646578	CES6...CES45	20	1
CES-MIL 65-300	004646579	CES65...CES300	130	1
CES-MIL 400	004646580	CES400	130	1



CES-MIL 6-45





CES-MIL 65-300

Only the same mechanical size contactors can be connected with mechanical interlock!

Contactor	Mechanical interlock offset setting	
	Q1, Q2	Y (mm)
CES-MIL 65-300	CES 65...75	0
	CES 85...105	8
	CES 140	8
	CES 170...205	16
	CES 250...300	36
CES-MIL 400	CES400	-

Y (mm) mechanical interlock offset setting

Surge suppressor

Type	Code No.	Coil voltage	For use with	 g	
CES-DIC3	004646581	24 - 250 VDC	CES6...CES32	15	1
CES-VR4	004646582	24-48 VAC	CES6...CES45	15	1
CES-VR5	004646583	127-240 VAC	CES6...CES45	15	1
CES-VR6	004646584	240-400 VAC	CES6...CES45	23	1
CES-VR7	004646585	24-48 VAC	CES65...CES400	14	1
CES-VR8	004646586	127-240 VAC	CES65...CES400	15	1



Already integrated in CES140...CES400



CES-DIC3



Overload relay

Thermal overload relays

Type	Code No.	Current setting range [A]	For use with	 g	
CES-RT0-0,4	004646587	0,25 - 0,4	CES6...CES18	140	1
CES-RT0-0,63	004646588	0,4 - 0,63	CES6...CES18	140	1
CES-RT0-1	004646589	0,63 - 1	CES6...CES18	140	1
CES-RT0-1,6	004646590	1 - 1,6	CES6...CES18	140	1
CES-RT0-2,5	004646591	1,6 - 2,5	CES6...CES18	140	1
CES-RT0-4.0	004646592	2,5 - 4	CES6...CES18	140	1
CES-RT0-6,3	004646593	4 - 6,3	CES6...CES18	140	1
CES-RT0-10	004646594	6,3 - 10	CES6...CES18	140	1
CES-RT0-12,5	004646595	8 - 12,5	CES6...CES18	140	1
CES-RT0-18	004646596	12,5 - 18	CES6...CES18	140	1
CES-RT1-16	004646597	10 - 16	CES25...CES32	200	1
CES-RT1-25	004646598	16 - 25	CES25...CES32	200	1
CES-RT1-32	004646599	25 - 32	CES25...CES32	200	1
CES-RT2-36	004646600	25 - 36	CES40...CES45	200	1
CES-RT2-45	004646601	36 - 45	CES40...CES45	200	1
CES-RT3-57	004646602	40 - 57	CES65...CES105	400	1
CES-RT3-70	004646603	57 - 70	CES65...CES105	400	1
CES-RT3-88	004646604	70 - 88	CES65...CES105	400	1
CES-RT3-105	004646605	88 - 105	CES65...CES105	400	1
CES-RT4-120	004646606	90 - 120	CES140...CES400	700	1
CES-RT4-135	004646607	110 - 135	CES140...CES400	700	1
CES-RT4-150	004646608	120 - 150	CES140...CES400	700	1
CES-RT4-160	004646609	135 - 160	CES140...CES400	700	1
CES-RT4-180	004646610	150 - 180	CES140...CES400	2.500	1
CES-RT4-250	004646611	160 - 250	CES140...CES400	2.500	1
CES-RT4-400	004646612	250 - 400	CES140...CES400	2.500	1



Overload relay mounting kits for rails TH35

Type	Code No.	For use with	 g	
CES-AD-RT0	004646613	CES-RT0	50	1
CES-AD-RT1	004646614	CES-RT1	50	1
CES-AD-RT2	004646615	CES-RT2	132	1
CES-AD-RT3	004646616	CES-RT3	164	1



Technical data according to IEC 60947-4-1

Type		CES-RT0	CES-RT1	CES-RT2	CES-RT3
General data					
Trip class		CLASS 10A (2s < t _A ≤ 10s at 7.2 x I _e from cold state)			
Phase failure sensitivity by differential phase shift		✓	✓	✓	✓
Changeover to automatic reset		✓	✓	✓	✓
RESET button with trip-free feature		✓	✓	✓	✓
Temperature compensation		✓	✓	✓	✓
Switch position indicator		✓	✓	✓	✓
Test button actuates the NO and NC contacts		✓	✓	✓	✓
Terminal for contactor coil		✓	✓	✓	✗ ¹⁾
Permissible ambient temperature	°C	-25 ... +55			
Degree of protection acc. to IEC 60947-1		IP00/open or IP20			
Shock resistance	g/ms	8/10			
Main circuit					
Rated insulation voltage U _i (Pollution degree 3)	AC/DCV	690			
Rated impulse withstand voltage U _{imp}	kV	6			
Type of current, frequency range		DC; AC ≤ 400 Hz			
Conductor cross-sections					
Terminal screw		M4	M5	M4	M5
solid or stranded	mm ²	2.5 ... 6	1.5 ... 25	1.5 ... 25	2.5 ... 35
finely stranded with end sleeve	mm ²	1.5 ... 4	1 ... 16	1 ... 16	1.5 ... 25
Flat bars	mm	--	--	--	--
Tightening torque	Nm	1 ... 1.5	2.5 ... 3	2.5 ... 3	2.5 ... 3
	lb.in	9 ... 13	22 ... 26.5	22 ... 26.5	22 ... 26.5
Power loss per conduction path (max.)					
at lowest value	W (VA)	0.9	1.2	1.2	2.6
at highest value of the setting range	W (VA)	2.25	3	3	4
Auxiliary circuit					
Auxiliary contacts		1 NO + 1 NC			
Conductor cross-sections					
Terminal screw		M3.5			
solid or stranded	mm ²	2 x (0.5 ... 1)/2 x (1 ... 2.5)			
finely stranded with end sleeve	mm ²	2 x (0.5 ... 1)/2 x (0.75 ... 2.5)			
Tightening torque	Nm	0.8 ... 1.4			
	lb.in	7 ... 12			
Rated insulation voltage U _i (pollution degree 3)		Unequal potential (NO + NC)	Equal potential (NO + NC connected as changeover contact)	Unequal potential (NO + NC)	Equal potential (NO + NC connected as changeover contact)
	V	400	690	400	690
Rated impulse withstand voltage U _{imp}	kV	6			
Switching capacity					
AC-15:					
Rated operational voltage U _e	V	24; 60; 125; 230; 400; 500; 690;			
Rated operational current I _e	A	2; 1.5; 1.25; 1.15; 1.1; 1; 0.8			
Conventional thermal current I _{th}	A	6			
Short-circuit protection		Fuses, utilization category gG 6A or miniature circuit-breaker with C-characteristics 3A			

Technical data according to IEC 60947-4-1

Main circuit		CES-RT4							
Current setting [Suggested]	A	90-120	110-135	120-150	135-160	150-180	170-205	160-250	250-400
Tripping class	Class	10A							
Protection functions	Tripping due to overload	✓							
	Tripping due to phase unbalance	✓							
	Tripping due to phase failure	✓							
	Phase failure sensitivity by differential phase shift	✓ (according to IEC60947-4-1)							
	Temperature compensation	✓							
Functions	Test button	✓							
	Reset button	Manual and Automatic RESET							
	Switch position indicator	✓							
	Terminal A2 for contactor coil connection	✗							
Functions	Operation	°C		-25 ... +55					
	Storage/transport	°C		-25 ... +70					
	Temperature compensation	°C		≤ 70					
Altitude without derating	m		≤ 2000						
Rated insulation voltage U _i (pollution degree 3)	V		1000						
Rated impulse withstand voltage U _{imp}	kV		6						
Type of current, frequency range	DC, AC ≤ 400Hz								
Degree of protection	IP00								
Touch protection	Finger-safe (with accessories)								
Resistance to extreme climates - air humidity	%		< 90%, 25° C; < 50%, 40° C						
Mounting	stand-alone mounting (the terminal busbar should fit contactor terminal)								
Terminals	Main current terminals	Busbar - Hex head							
	Auxiliary contact terminal	Remain as existing							
Max. wire diameter size	Single wire	mm ²		50 ... 120				≤ 200 A: 185, > 200 : 240	
	Stranded wire	mm ²							
	finely stranded with end sleeve	mm ²		25 ... 95				----	
	Terminal size	[mm x mm]		20 x 3				20 x 3 / 2 x 30 x 5	
Auxiliary circuit									
Number of NO contacts		1	1	1	1	1	1	1	1
Number of NC contacts		1	1	1	1	1	1	1	1
Rated insulation voltage U _i (pollution degree 3)	V		≥ 400						
Rated impulse withstand voltage U _{imp}	kV		6						
Conventional thermal current I _{th}	A		6						
Rated operational current I _e AC-15	A		U _e =220V, I _e =1.15A; U _e =380V, I _e =1.1A						
Dimensions H / B / T ; Width	mm		≤ 104mm		≤ 104mm		≤ 150mm		
Certificates & Standards		CE, RoHS							

Short circuit protection with fuses for motor feeders with short-circuit currents up to 50 kA at 690V, 50/60 Hz¹⁾
Permissible short-circuit fuses for motor starters consisting of overload relay and contactor, contactor assembly

Technical data according to IEC 60947-4-1

Setting range	Fuse links					
	Fuses, utilization category gG		Fuses, utilization category aM	Fuses acc. to British Standards BS 88 Type T		
	Type of coordination ²⁾		Type of coordination ²⁾	Type of coordination ²⁾		
A	"1"	"2"	"2"	"1"	"2"	
A	A	A	A	A	A	
CES-RT0						
0.1 ... 0.16	35	0.5 slow ³⁾	--	25	--	
0.16 ... 0.25	35	1 ³⁾	--	25		
0.25 ... 0.4	35	1.6 ³⁾	--	25		
0.4 ... 0.63	35	2	--	25	2	
0.63 ... 1	35	4	--	25	4	
1 ... 1.6	35	6	--	25	6	
1.6 ... 2.5	35	6	--	25	10	
2.5 ... 4	35	10	--	25	10	
4 ... 6.3	35	16	--	25	16	
6.3 ... 10	35	25	--	25	20	
8 ... 12.5	35	25	--	25	20	
12.5 ... 18	35	25	--	25	25	
CES-RT1						
6.3 ... 10	63	25		63	25	
10 ... 16	63	35	20	63	35	
16 ... 25	63	50	40	63	50	
25 ... 32	63	50	50	63	50	
Setting range	Fuse links					
	Fuses, utilization category gG		Fuses, utilization category aM	Fuses acc. to British Standards BS 88 Type T		
	Type of coordination ²⁾		Type of coordination ²⁾	Type of coordination ²⁾		
A	"1"	"2"	"2"	"1"	"2"	
A	A	A	A	A	A	
CES-RT2						
16 ... 25	80	50		100	10	
25 ... 36	80	80		100	10	
36 ... 45	80	80	--	100	16	
CES-RT3						
40 ... 57	160	125	63	160	100	
57 ... 70	160	125	63	160	100	
70 ... 88	250	160	100	160	125	
88 ... 105	250	200	125	160	200	
CES-RT4						
90 ... 120	315	224	125	315	224	
110 ... 135	315	224	160	315	224	
120 ... 150	315	224	160	315	224	
135 ... 160	355	224	160	355	224	
150 ... 180	355	224	200	355	224	
160 ... 250	500	400	250	500	400	
250 ... 400	800	500	400	800	500	

1) Voltage tolerance +5 %.

2) Coordination of short-circuit equipment according to IEC 60947-4-1:

Type of coordination "1":

The contactor or starter must not endanger persons or the installation in the event of a short-circuit.

They do not need to be suitable for further operation without repair and the renewal of parts.

Type of coordination "2":

The contactor or starter must not endanger persons or the installation and must be suitable for further use.

There is a danger of contact welding.

3) D-fuse links $U_N = 500$ V

Dimensional drawings

CES-RT0, CES-RT1, with stand-alone adapter

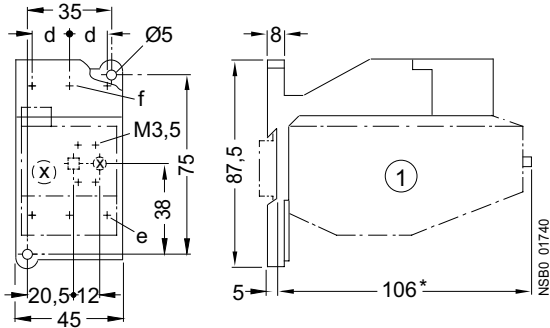

	d	e	f
CES-RT0 & CES-AD-RT0	10	M4	M3.5
CES-RT1 & CES-AD-RT1	14.3	M5	M4

CES-RT2 with CES-AD-RT2 stand-alone adapter

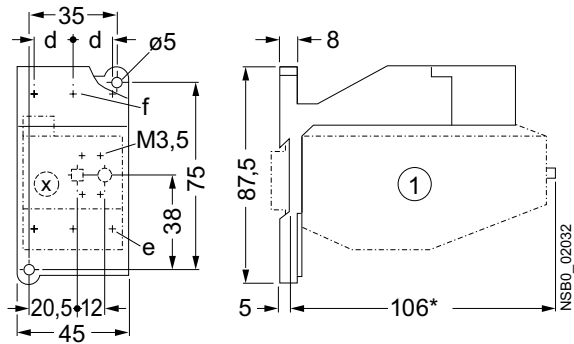

	d	e	f
CES-RT2 & CES-AD-RT2	18.5	M5	M5

CES-RT3 with CES-AD-RT3 stand-alone adapter

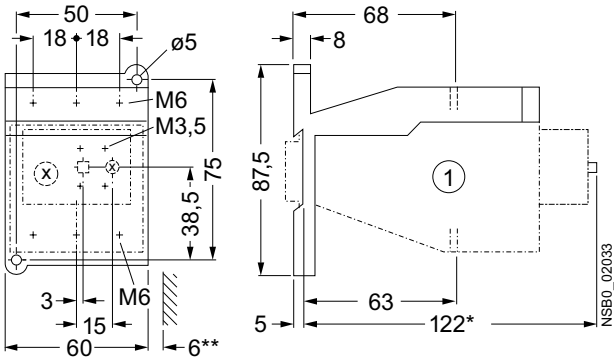

APPLICATION NOTE:

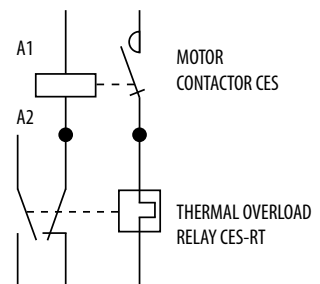

CES-RT4 120, 135, 150

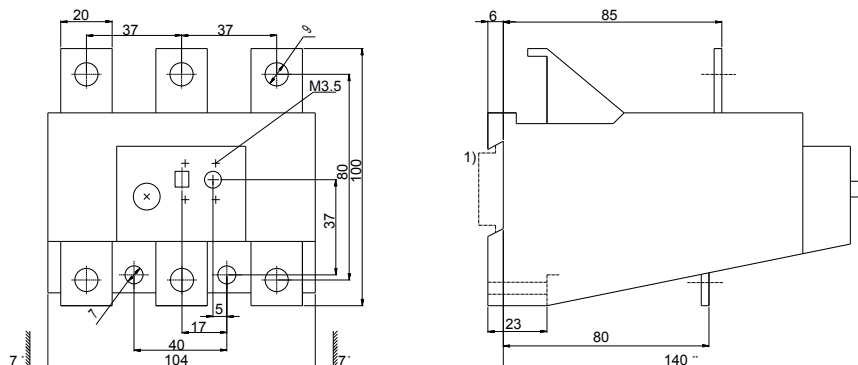

* Dimension for the ground engaging component

** Dimension for the square OFF-button (stroke 3mm)
Dimension for the round RESET-button (Stroke 2.5mm) less 2.5mm

1) For 35mm standard (DIN) mounting rail

CES-RT4 160, 180

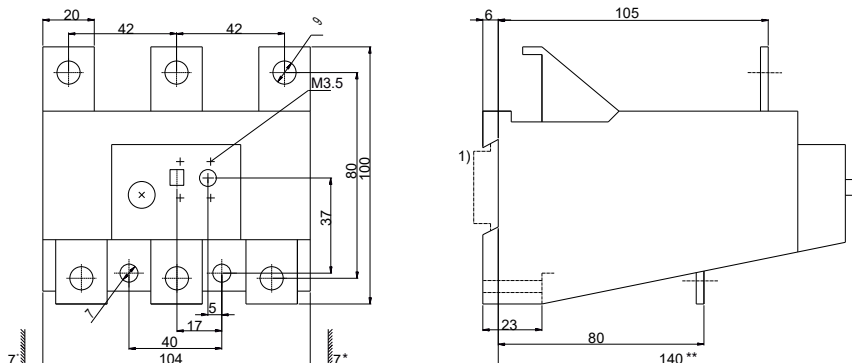

* Dimension for the ground engaging component

** Dimension for the square OFF-button (stroke 3mm)
Dimension for the round RESET-button (Stroke 2.5mm) less 2.5mm

1) For 35mm standard (DIN) mounting rail

CES-RT4 250, 400

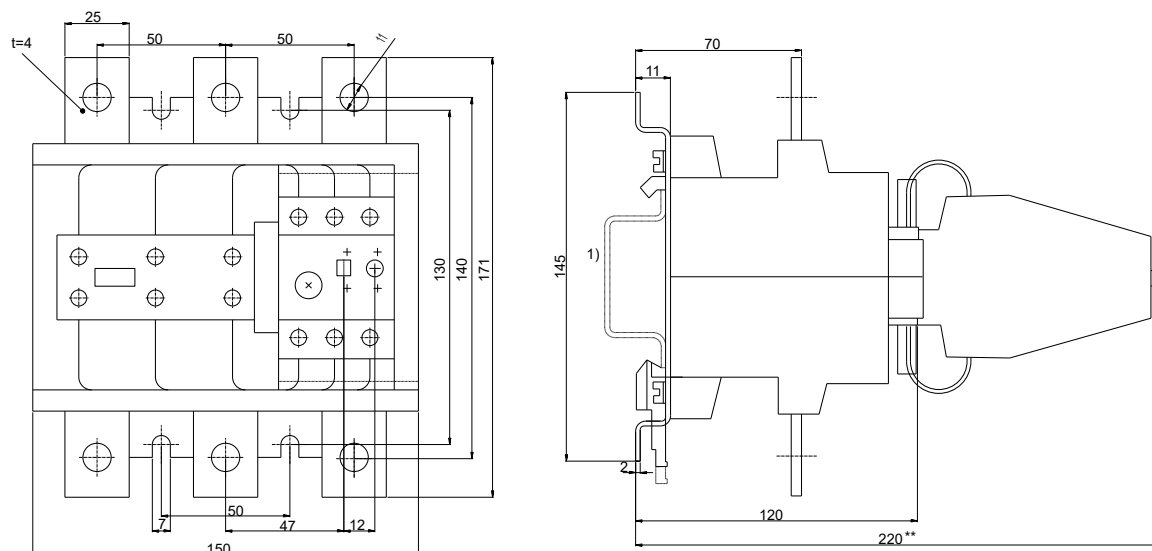

** Dimension for the square OFF-button (Stroke 3mm)
Dimension for the round RESET-button (Stroke 2.5mm) less 2.5mm

1) For 35mm standard (DIN) mounting rail

Motor contactor CEM

Application

Contactors are used to remotely control and protect (in combination with overload relays) electric motors and other electric loads with nominal power up to 300kW (at 400V AC3 duty).

Advantages

- // Mounting on DIN rail and mounting plates
- // High technical performance
- // Low power loss (current heat loss)
- // Protection against direct contact from front (IEC 536) IP20
- // Wide range of accessories
- // Surge suppressor (as option)
- // Control voltage 24VAC, 48VAC, 110VAC, 230VAC, 400VAC

IE3 CONFORM



Ordering:

CEM9.01-230V-50/60Hz

I(AC3)[A]

Nr. of NO Nr. of NC - Number and type of auxiliary contacts

Coil voltage

- Possible to exchange coils with different coil voltages.



- Additionally EMC filter can be connected close to coil to suppress RF signals and surges.



- Lateral (side mounting) of auxiliary contacts.



- Mechanical interlock can lock two different size contactors
New: mechanical interlock with integrated aux. contacts BLIME 9-105 02.



- Front mounted auxiliary contacts

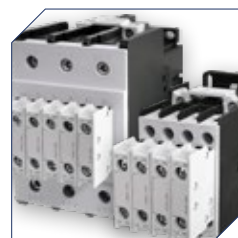

- CEM 32 ... CEM105 Contactor terminals allow simultaneous connection not only single-stranded and stranded conductors, but also conductors of different sections.

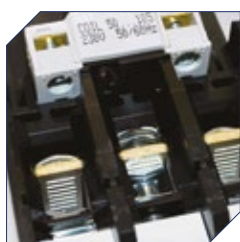

- Mounting on DIN rail or directly on panel.

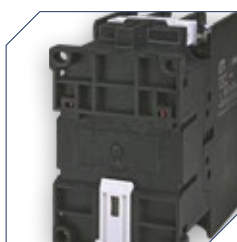

- Wide range of bimetal relays for overload protection. Possible to install directly on contactor or on DIN rail by using additional adapter BF.



/// Built in Varistor (EMC filter).



/// Replacement control coils and electronics available.

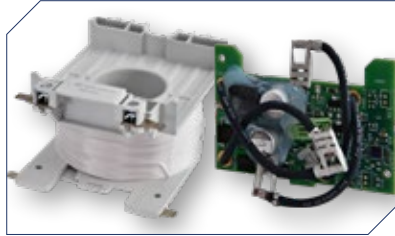

/// Additional protection covers against touch.



/// Possibility to install additional 2nd aux. contact block on each side of contactor.



/// Additional TBE terminals allow simultaneous connection not only single-stranded and stranded conductors, but also conductors of different sections.



/// Possible to install mechanical interlock between 2 contactors.

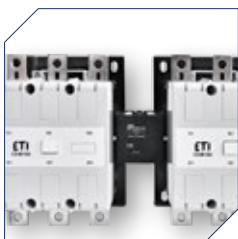

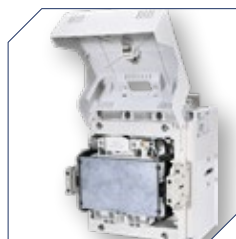

/// Easy access for maintenance and visual control of damages.

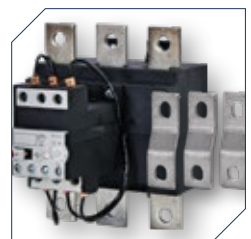

/// Overload bimetal relays for overload protection are available.



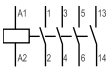

Motor contactor CEM9.10; 25A(AC1); 9A; 4kW(AC3)*

Type	Code No.	Wiring diagram		
CEM9.10-24V-50/60Hz	004642120		295	1
CEM9.10-48V-50/60Hz	004642121		295	1
CEM9.10-110V-50/60Hz	004642122		295	1
CEM9.10-230V-50/60Hz	004642123		295	1
CEM9.10-400V-50/60Hz	004642124		295	1
CEM9.10-24V DC	004642220		510	1
CEM9.10-220V DC	004642221		510	1

* Auxiliary contact 1NO integrated

Motor contactor CEM9.01; 25A(AC1); 9A; 4kW(AC3)*

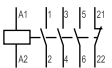

Type	Code No.	Wiring diagram		
CEM9.01-24V-50/60Hz	004642110		295	1
CEM9.01-48V-50/60Hz	004642111		295	1
CEM9.01-110V-50/60Hz	004642112		295	1
CEM9.01-230V-50/60Hz	004642113		295	1
CEM9.01-400V-50/60Hz	004642114		295	1
CEM9.01-24V DC	004642210		510	1
CEM9.01-220V DC	004642211		510	1

* Auxiliary contact 1NC integrated



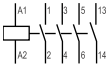

For auxiliary contact blocks, see page 334

Motor contactor CEM12.10; 25A(AC1); 12A; 5.5kW(AC3)*

Type	Code No.	Wiring diagram		
CEM12.10-24V-50/60Hz	004643120		295	1
CEM12.10-48V-50/60Hz	004643121		295	1
CEM12.10-110V-50/60Hz	004643122		295	1
CEM12.10-230V-50/60Hz	004643123		295	1
CEM12.10-400V-50/60Hz	004643124		295	1
CEM12.10-24V DC	004643220		510	1
CEM12.10-220V DC	004643221		510	1

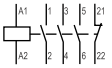

* Auxiliary contact 1NO integrated

**Motor contactor CEM12.01; 25A(AC1); 12A; 5.5kW(AC3)***

Type	Code No.	Wiring diagram		
CEM12.01-24V-50/60Hz	004643110		295	1
CEM12.01-48V-50/60Hz	004643111		295	1
CEM12.01-110V-50/60Hz	004643112		295	1
CEM12.01-230V-50/60Hz	004643113		295	1
CEM12.01-400V-50/60Hz	004643114		295	1
CEM12.01-24V DC	004643210		510	1
CEM12.01-220V DC	004643211		510	1

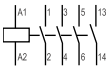

* Auxiliary contact 1NC integrated

Motor contactor CEM18.10; 32A(AC1); 18A; 7.5kW(AC3)*

Type	Code No.	Wiring diagram		
CEM18.10-24V-50/60Hz	004644120		295	1
CEM18.10-48V-50/60Hz	004644121		295	1
CEM18.10-110V-50/60Hz	004644122		295	1
CEM18.10-230V-50/60Hz	004644123		295	1
CEM18.10-400V-50/60Hz	004644124		295	1
CEM18.10-24V DC	004644220		510	1
CEM18.10-220V DC	004644221		510	1

* Auxiliary contact 1NO integrated

Motor contactor CEM18.01; 32A(AC1); 18A; 7.5kW(AC3)*

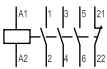

Type	Code No.	Wiring diagram		
CEM18.01-24V-50/60Hz	004644110		295	1
CEM18.01-48V-50/60Hz	004644111		295	1
CEM18.01-110V-50/60Hz	004644112		295	1
CEM18.01-230V-50/60Hz	004644113		295	1
CEM18.01-400V-50/60Hz	004644114		295	1
CEM18.01-24V DC	004644210		510	1
CEM18.01-220V DC	004644211		510	1

* Auxiliary contact 1NC integrated



For auxiliary contact blocks, see page 334



Motor contactor CEM25.00; 45A(AC1); 25A; 11kW(AC3)

Type	Code No.	Wiring diagram		
CEM25.00-24V-50/60Hz	004645100		295	1
CEM25.00-48V-50/60Hz	004645101		295	1
CEM25.00-110V-50/60Hz	004645102		295	1
CEM25.00-230V-50/60Hz	004645103		295	1
CEM25.00-400V-50/60Hz	004645104		295	1
CEM25.00-24V DC	004645200		510	1
CEM25.00-220V DC	004645201		510	1

For different configurations of auxiliary contacts up to 4 auxiliary contacts can be added to contactor and must be ordered separately.





Motor contactor CEM32.00; 60A(AC1); 32A; 15kW(AC3)

Type	Code No.	Wiring diagram		
CEM32.00-24V-50/60Hz	004646100		520	1
CEM32.00-48V-50/60Hz	004646101		520	1
CEM32.00-110V-50/60Hz	004646102		520	1
CEM32.00-230V-50/60Hz	004646103		520	1
CEM32.00-400V-50/60Hz	004646104		520	1
CEM32.00-24V DC**	004646200		850	1
CEM32.00-220V DC**	004646201		850	1

For different configurations of auxiliary contacts up to 4 auxiliary contacts can be added to contactor and must be ordered separately.

** 24V DC (24...28 V DC), 220V DC (208...240V DC)



Motor contactor CEM40.00; 60A(AC1); 40A; 18.5kW(AC3)

Type	Code No.	Wiring diagram	 g	
CEM40.00-24V-50/60Hz	004647100		540	1
CEM40.00-48V-50/60Hz	004647101		540	1
CEM40.00-110V-50/60Hz	004647102		540	1
CEM40.00-230V-50/60Hz	004647103		540	1
CEM40.00-400V-50/60Hz	004647104		540	1
CEM40.00-24V DC**	004647200		850	1
CEM40.00-220V DC**	004647201		850	1

For different configurations of auxiliary contacts up to 4 auxiliary contacts can be added to contactor and must be ordered separately

** 24V DC (24...28 V DC), 220V DC (208...240V DC).



**Motor contactor CEM50.00; 80A(AC1); 50A; 22kW(AC3)**

Type	Code No.	Wiring diagram	 g	
CEM50.00-24V-50/60Hz	004648100		1105	1
CEM50.00-48V-50/60Hz	004648101		1105	1
CEM50.00-110V-50/60Hz	004648102		1105	1
CEM50.00-230V-50/60Hz	004648103		1105	1
CEM50.00-400V-50/60Hz	004648104		1105	1
CEM50.00-24V DC**	004648200		1240	1
CEM50.00-220V DC**	004648201		1240	1

For different configurations of auxiliary contacts up to 6 auxiliary contacts can be added to contactor and must be ordered separately.

** 24V DC (24...28 V DC), 220V DC (208...240V DC)

**Motor contactor CEM65.00; 110A(AC1); 65A; 30kW(AC3)**



Type	Code No.	Wiring diagram	 g	
CEM65.00-24V-50/60Hz	004649100		1120	1
CEM65.00-48V-50/60Hz	004649101		1120	1
CEM65.00-110V-50/60Hz	004649102		1120	1
CEM65.00-230V-50/60Hz	004649103		1120	1
CEM65.00-400V-50/60Hz	004649104		1120	1
CEM65.00-24V DC**	004649200		1240	1
CEM65.00-220V DC**	004649201		1240	1

For different configurations of auxiliary contacts up to 6 auxiliary contacts can be added to contactor and must be ordered separately.

** 24V DC (24...28 V DC), 220V DC (208...240V DC)

For auxiliary contact blocks, see page 334

**Motor contactor CEM80.00; 110A(AC1); 80A; 37kW(AC3)**



Type	Code No.	Wiring diagram	 g	
CEM80.00-24V-50/60Hz	004650100		1130	1
CEM80.00-48V-50/60Hz	004650101		1130	1
CEM80.00-110V-50/60Hz	004650102		1130	1
CEM80.00-230V-50/60Hz	004650103		1130	1
CEM80.00-400V-50/60Hz	004650104		1130	1
CEM80.00-24V DC**	004650200		1240	1
CEM80.00-220V DC**	004650201		1240	1

For different configurations of auxiliary contacts up to 6 auxiliary contacts can be added to contactor and must be ordered separately.

** 24V DC (24...28 V DC), 220V DC (208...240V DC)

** Range of operating voltages is shown in technical part of catalogue



Motor contactor CEM95.00; 140A(AC1); 95A; 45kW(AC3)

Type	Code No.	Wiring diagram		
CEM95.00-24V-50/60Hz	004651100		1450	1
CEM95.00-48V-50/60Hz	004651101		1450	1
CEM95.00-110V-50/60Hz	004651102		1450	1
CEM95.00-230V-50/60Hz	004651103		1450	1
CEM95.00-400V-50/60Hz	004651104		1450	1
CEM95.00-24V DC **	004651200		1500	1
CEM95.00-220V DC **	004651201		1500	1

For different configurations of auxiliary contacts up to 6 auxiliary contacts can be added to contactor and must be ordered separately.

** 24V DC (24...28 V DC), 220V DC (208...240V DC)

Motor contactor CEM105.00; 140A(AC1); 105A; 55kW(AC3)

Type	Code No.	Wiring diagram		
CEM105.00-24V-50/60Hz	004652100		1470	1
CEM105.00-48V-50/60Hz	004652101		1470	1
CEM105.00-110V-50/60Hz	004652102		1470	1
CEM105.00-230V-50/60Hz	004652103		1470	1
CEM105.00-400V-50/60Hz	004652104		1470	1
CEM105.00-24V DC **	004652200		1500	1
CEM105.00-220V DC **	004652201		1500	1



For different configurations of auxiliary contacts up to 6 auxiliary contacts can be added to contactor and must be ordered separately.

** 24V DC (24...28 V DC), 220V DC (208...240V DC)



For auxiliary contact blocks, see page 334

Motor contactor CEM112.22(E); 180A(AC1); 112A; 55kW(AC3)*

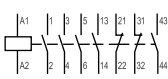
Type	Code No.	Wiring diagram		
CEM112.22-24V-50/60Hz	004653140		2400	1
CEM112.22-48V-50/60Hz	004653141			
CEM112.22-110V-50/60Hz	004653142			
CEM112.22-230V-50/60Hz	004653143			
CEM112.22-400V-50/60Hz	004653144			
CEM112E.22-28V AC/DC **	004646018			
CEM112E.22-130V AC/DC **	004646019			
CEM112E.22-250V AC/DC **	004646020			
CEM112E.22-415V AC/DC **	004646021			



* Integrated auxiliary contacts: two side mounted auxiliary contact blocks 2 X (1NO + 1 NC)

**28V AC/DC (24...28V), 130V AC/DC (110...130V), 250V AC/DC (208...250V), 415V AC/DC (360...415V)

Surge suppressor is already integrated

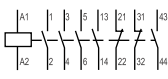

Motor contactor CEM150E.22; 225A(AC1); 150A; 75kW(AC3)*

Type	Code No.	Wiring diagram		
CEM150E.22-28V AC/DC **	004654240		2400	1
CEM150E.22-130V AC/DC **	004646023			
CEM150E.22-250V AC/DC **	004654241			
CEM150E.22-415V AC/DC **	004646025			

* Integrated auxiliary contacts: two side mounted auxiliary contact blocks 2 X (1NO + 1 NC)

**28V AC/DC (24...28V), 130V AC/DC (110...130V), 250V AC/DC (208...250V), 415V AC/DC (360...415V)

Surge suppressor is already integrated



Motor contactor CEM180.22(E); 225A(AC1); 180A; 90kW(AC3)*

Type	Code No.	Wiring diagram	g	Box
CEM180.22-24V-50/60Hz	004655140		3900	1
CEM180.22-48V-50/60Hz	004655141			
CEM180.22-110V-50/60Hz	004655142			
CEM180.22-230V-50/60Hz	004655143			
CEM180.22-400V-50/60Hz	004655144			
CEM180E.22-28V AC/DC **	004646029			
CEM180E.22-130V AC/DC **	004646026			
CEM180E.22-250V AC/DC **	004646027			
CEM180E.22-415V AC/DC **	004646028			

* Integrated auxiliary contacts: two side mounted auxiliary contact blocks 2 X (1NO + 1 NC)

**28V AC/DC (24...28V), 130V AC/DC (110...130V), 250V AC/DC (208...250V), 415V AC/DC (360...415V)

Surge suppressor is already integrated

**Motor contactor CEM250.22(E); 350A(AC1); 250A; 132kW(AC3)***

Type	Code No.	Wiring diagram	g	Box
CEM250.22-24V-50/60Hz	004656140		6000	1
CEM250.22-48V-50/60Hz	004656141			
CEM250.22-110V-50/60Hz	004656142			
CEM250.22-230V-50/60Hz	004656143			
CEM250.22-400V-50/60Hz	004656144			
CEM250E.22-28V AC/DC **	004646030			
CEM250E.22-130V AC/DC **	004646031			
CEM250E.22-250V AC/DC **	004646032			
CEM250E.22-415V AC/DC **	004646033			

* Integrated auxiliary contacts: two side mounted auxiliary contact blocks 2 X (1NO + 1 NC)

**28V AC/DC (24...28V), 130V AC/DC (110...130V), 250V AC/DC (208...250V), 415V AC/DC (360...415V)

Surge suppressor is already integrated

** Range of operating voltages is shown in the technical part of catalogue



For auxiliary contact blocks, see page 334

Motor contactor CEM300.22(E), 410A(AC1), 300A, 160kW(AC3)*

Type	Code No.	Wiring diagram	g	Box
CEM300E.22-28V AC/DC	004656300		6900	1
CEM300E.22-50V AC/DC	004656301			
CEM300E.22-72V AC/DC	004656302			
CEM300E.22-130V AC/DC	004656303			
CEM300E.22-250V AC/DC	004656304			
CEM300E.22-415V AC/DC	004656305			



* Integrated auxiliary contacts: two side mounted auxiliary contact blocks 2 X (1NO + 1 NC)

**28V AC/DC (24...28V), 130V AC/DC (110...130V), 250V AC/DC (208...250V), 415V AC/DC (360...415V)

Surge suppressor is already integrated



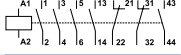

Motor contactor CEM450.22(E), 600A(AC1), 450A, 260kW(AC3)*

Type	Code No.	Wiring diagram		
CEM450E.22-255V AC/DC	004656306		12000	1

* Integrated auxiliary contacts: two side mounted auxiliary contact blocks 2 X (1NO + 1 NC)
Surge suppressor is already integrated

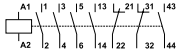

Motor contactor CEM560.22(E), 700A(AC1), 560A, 300kW(AC3)*

Type	Code No.	Wiring diagram		
CEM560E.22-255V AC/DC	004656307		12000	1

* Integrated auxiliary contacts: two side mounted auxiliary contact blocks 2 X (1NO + 1 NC)
Surge suppressor is already integrated







Contactors CEM up to 132 kW Technical Data

Type	CEM 9	CEM 12	CEM 18	CEM 25	CEM 32	CEM 40	CEM 50	CEM 65	CEM 80	CEM 95	CEM 105	CEM 112E	CEM 150E	CEM 180E	CEM 250E	CEM 300E
Standards	IEC/EN 60 947, DIN VDE 0660															
Rated insulation voltage U_i (V) to IEC/EN 60 947, DIN VDE 0660	1000 V															
Rated impulse withstand voltage U_{imp}	6 kV								8 kV							
Rated operational frequency	25 - 400 Hz															
Degree of protection	Protection against direct contact from the front when actuated by a perpendicular test finger (IEC 536)															
Main circuits	IP20						IP10						IP00			
Control circuits and auxiliary contacts	IP20															
Ambient temperature	-25 ... +55 °C															
Operating temperature	-25 ... +55 °C															
Storage temperature	-55 ... +80 °C															
Altitude																
Normal values																
90 % I_e /80 % U_e	≤ 3000 m															
80 % I_e /75 % U_e	3000 ... 4000 m															
	4000 ... 5000 m															
Overvoltage category/Pollution degree	III/3															
Climatic proofing	IEC 68-2															
Main circuits																
Number of poles	3	3	3	3	3	3	3	3	3	3	3	3	3	3	3	3
Rated operation voltage U_e	690 V								1000V							
Conv. thermal current I_{th} at ≤ 55°C																
Rated operational current I_n /AC-1	25 A	25 A	32 A	45 A	60 A	60 A	90 A	110 A	110 A	140 A	140 A	180 A	225 A	225 A	350A	410A
AC-3 Duty																
Rated operational power																
230 V kW	2,2	3	4	6,5	9	11	15	18,5	22	25	30	30	45	55	75	90
400 V kW	4	5,5	7,5	11	15	18,5	22	30	37	45	55	55	75	90	132	160
415-440 V kW	4,5	5,5	9	12,5	15	22	30	37	45	55	55	55	90	110	150	185
500 V kW	5,5	7,5	10	15	18,5	25	30	40	45	55	65	75	90	110	160	200
690 V kW	5,5	7,5	10	15	18,5	30	33	45	45	55	65	80	80	132	200	200
Short circuit rating																
max. fuse gG (A)	25	35	35	50	63	80	100	125	125	160	200	224	250	250	400	500

Contactors CEM up to 132 kW Technical Data

Type		CEM 9	CEM 12	CEM 18	CEM 25	CEM 32	CEM 40	CEM 50	CEM 65	CEM 80	CEM 95	CEM 105	CEM 112E	CEM 150E	CEM 180E	CEM 250E	CEM 300E				
max. electrical operating frequency																					
AC-1	Ops/h	1200	1200	1200	1200	1200	1200	1200	1200	1200	1200	1200	600	600	600	600	600				
AC-3	Ops/h	1200	1200	1200	1200	1200	1200	1200	1200	1200	600	600	600	600	600	600	600				
AC-4	Ops/h	360	360	360	360	360	360	200	200	200	200	200	150	150	150	150	150				
no load	Ops/h	9000	9000	9000	9000	9000	9000	5000	5000	5000	5000	5000	4000	4000	4000	4000	4000				
Mechanical life span	Ops x 106	10																			
Electrical life span	Ops x 106	1,6	1,8	1,2				1,1				1,0									
Control circuit																					
Rated insulation voltage	U _i (V)	1000 V																			
Nominal voltages	U _s 50 Hz (V)	24 - 690 V																			
Nominal voltages	U _s 60 Hz (V)	24 - 690 V																			
Nominal voltages	U _s DC (V)	12 - 440 V																			
Pick-up and drop-out values																					
Pick-up x	U _s (V)	0,8 - 1,1				0,8 - 1,1				0,8 - 1,1				0,8 - 1,1							
Drop-out x	U _s (V)	0,35 - 0,55				0,4 - 0,6				0,4 - 0,6				0,3 - 0,5							
Control circuit alternating current AC																					
Opening and closing times (Valid at U _s)																					
Between coil energization and NO contact closing	(ms)	8 ... 20				10 ... 19				15 ... 30				15 ... 30		20 ... 30		30 ... 50		35 ... 50	
Between coil de-energization and NO contact opening	(ms)	6 ... 13				5 ... 25				9 ... 15				9 ... 15		10 ... 26		10 ... 26		12 ... 26	
Control circuit direct current DC																					
Opening and closing times (Valid at U _s)																					
Between coil energization and NO contact closing	(ms)	35 ... 45				50 ... 60				50 ... 60				50 ... 60							
Between coil de-energization and NO contact opening	(ms)	7 ... 12				55 ... 60				55 ... 60				55 ... 60							
Power consumption of the coil 50/60 Hz																					
Pick-up	(VA)	70				98				255				213		214		229			
	(cos φ)	0,85				0,69				0,32				0,71		0,68		0,73			
Sealing	(VA)	4...7,2				6,6...12,3				13,1...19,1				14,8		14,5		14,1			
	(cos φ)	0,28				0,34				0,54				0,26		0,27		0,26			
Power consumption of the coil, DC coils																					
Pick-up	(W)	3,8...7,5				240				340				166		154		171			
Sealing	(W)	3,8...7,5				6				6,5				2,4		2,4		2,5			
Power dissipations																					
PD per pole @ Ie AC-3	(W)	0,2	0,3	0,8	1	1,3	1,5	2,1	3,6	5,5	6,9	8,4	6,2	11,1	13,8	17,9	25,7				
PD of coils, AC coils	(W)	2,0	2,0	2,0	2,0	4,2	4,2	10,3	10,3	10,3	10,3	10,3	3,9	3,9	3,9	3,7	3,7				
PD of coils, DC coils	(W)	7,5	7,5	7,5	7,5	6	6	6,5	6,5	6,5	6,5	6,5	2,4	2,4	2,4	2,5	2,5				

Contactors CEM up to 132 kW Technical Data

Type		CEM 9 ... CEM 18	CEM25	CEM32 & CEM40	CEM50 & CEM80	CEM95 & CEM105	CEM112E & CEM 150E	CEM180E	CEM250E & CEM300E
Main terminal capacity (mm ²)									
Solid, stranded and finely stranded without end sleeve		2x (1... 2,5)	2x (1... 2,5)						
		2x (2,5...6)	2x (2,5... 10)						
Finally stranded with end sleeve		2x (0,25...2,5)	2x (1...2,5)						
		2x (2,5...6)	2x (2,5...10)						
		2x (13...16)	2x (13...17)						
One conductor on top									
Stranded				0,75...16	1...35	1,5...50			
Stranded with end sleeve				0,75...16	1...35	1,5...50			
Stranded without end sleeve					1...16	1,5...35	2,5...50		
Finally stranded					1...16	1,5...35	2,5...50		
One conductor on bottom									
Solid				1...16	2,5...35	4...35			
Stranded with end sleeve				1... 16	2,5...35	4...35			
Stranded without end sleeve					1,5...16	6...35	6...35		
Finally stranded					1,5...16	6...35	6...35		
Two conductors on top									
Solid				0,75...16	1...35	1,5...50			
Stranded with end sleeve				0,75...16	1...35	1,5...50			
Stranded without end sleeve					1...16	1,5...35	2,5...50		
Finally stranded					1...16	1,5...35	2,5...50		
Two conductors on bottom									
Solid				1...16	2,5...35	4...35			
Stranded with end sleeve				1...16	2,5...35	4...35			
Stranded without end sleeve					1,5...16	6...35	6...35		
Finally stranded					1,5...16	6...35	6...35		
Solid and stranded with end sleeve Bar							2 x (25...70) 2 x (15x3)	2 x (50... 120) 2 x (20x3)	2 x (50...150) 2 x (30x5)
Tightening torque (N.m)		1...1,7	1,6...3	2...2,5	4...6	5...6,5	10	13	17

Auxiliary contacts

Type		CEM9	CEM12	CEM18	BCXMF... ..	BCXMLE ...
Rated insulation voltage U _i						
acc. IEC/EN 60 947	(V)		1000			1000
Rated operational voltage U _e						
	(V)		690			690
Conv. thermal current I _{th}						
	(A)		20			10
Rated operational current I _e						
AC-15	220 - 240 V	(A)	10			6
	380 - 400 V	(A)	6			4
	415 V	(A)	5			3,5
	500 V	(A)	4			2,5
DC-13	24 V	(A)	6			6
	48 V	(A)	4			4
	110 V	(A)	2			2
	220 V	(A)	0,7			0,7
Making capacity I _m						
AC-15/AC-11	U _e ≤ 400 V 50/60 Hz	(A)	250			90
DC-13/DC-11	U _e ≤ 220 V DC	(A)	250			90
Breaking capacity I _c						
AC-15/AC-11	U _e ≤ 400 V 50/60 Hz	(A)	250			60
DC-13/DC-11	U _e ≤ 220 V DC	(A)	2			0,95
Short circuit protection						
max. fuse gG	(A)		16			10
Control circuit reliability						
Electrical life span				I _e min. = 5 mA, U _e min. = 17 V		
Mechanical life span				106		
Impedance /pole	mR			15 x 106		
				2,5		

Power Circuit - CEM 450-560

Three pole version		CEM450	CEM560
Rated thermal current I_{th} (temp $\leq 55^\circ\text{C}$)	(A)	600	700
Rated operational current I_e AC-3 ($U_e \leq 440\text{V}$)	(A)	450	560
Rated operational voltage U_e	acc. IEC / VDE 0660	(V)	1000
	acc. UL / CSA	(V)	-
Rated insulation voltage U_i (pollution degree 3)	acc. IEC / VDE 0660	(V)	1000
	acc. UL / CSA	(V)	-
Rated impulse withstand voltage U_{imp} (acc. IEC 60947-1)	(kV)	8	8
Maximum continuous current AC-1 (temp $\leq 55^\circ\text{C}$)	(A)	600	690
Rated operational current I_e AC-4 ($U_e \leq 440\text{V}$)	(A)	280	345
Frequency limits	(Hz)	25...400	25...400
Making capacity (RMS) (IEC 60947)	(A)	5600	6300
Breaking capacity (RMS) (IEC 60947)	($U_e \leq 400\text{V}$)	(A)	4480
	($U_e = 500\text{V}$)	(A)	4480
	($U_e = 550\text{V}$)	(A)	4009
	($U_e = 690\text{V}$)	(A)	3000
Short-time current	1 seg	(A)	8544
	5 seg	(A)	5733
	10 seg	(A)	4500
	30 seg	(A)	2990
	1 min	(A)	2208
(at temp $\leq 40^\circ\text{C}$)	3 min	(A)	1391
No current flowing during recovery time.	Recovery time	(min.)	10
Electrical Endurance at I_e AC-3 (IEC 60947)	ops. (million)	0,6	0,6
Protection against short-circuits with fuses. Without TOR			
Coordination type "1"	gL/gG	(A)	1000
Coordination type "2"	gL/gG	(A)	630
Without welding	gL/gG	(A)	500
Short-circuit Interrupting Capacity	600V - acc. UL/CSA	(kA)	-
Impedance per pole		(m Ω)	0,2
Power dissipation per pole	AC-1	(W)	72
	AC-3	(W)	41
Insulation resistance between adjacent poles, poles and earth and between input and output			> 10M Ω
Degree of protection (acc. VDE 0160 - Part 100)	Main terminals		IP00
	Coil terminals		IP20
Relative Humidity			5 to 95% at 40°C (non-condensing)
Mounting			Screw to panel

AC - Utilisation Category for CEM 450-560

Utilisation category AC-1		CEM450	CEM560
Rated thermal current I_{th} (temp $\leq 55^\circ\text{C}$)	(A)	600	690
Max. Operational current at ambient temperature of. (up to 690V)"	55 °C	(A)	600
	70 °C	(A)	370
	75 °C	(A)	-
Max. Operational power (q $\leq 55^\circ\text{C}$) (Three-phase resistors)	220 / 230 V	(kW)	228
	380 / 400 V	(kW)	395
	415 / 440 V	(kW)	431
	500 V	(kW)	520
	575 / 600 V	(kW)	598
	660 / 690 V	(kW)	685
Cable size	(mm ²)	2 x (50x5)	
Current values for connection of	2 poles in parallel	$I_e \times 1,7$	
	3 poles in parallel	$I_e \times 2,4$	
Percentage of the max. operational current at	600 ops./h	(%)	100
	1200 ops./h	(%)	80
	3000 ops./h	(%)	-
		(%)	-

AC - Utilisation Category for CEM 450-560

Utilisation category AC-3		CEM450	CEM560
Operational current I_e (temp $\leq 55^\circ\text{C}$)	$U_e \leq 440\text{V}$	(A)	450
	500 V	(A)	415
	550 V	(A)	380
	690 V	(A)	315
	1000 V	(A)	200
"Max. Operational power Three-phase motors (50/60 Hz)"	220 / 230 V	(kW)	150
		(HP)	200
	380 / 400 V	(kW)	260
		(HP)	350
	415 / 440 V	(kW)	260
		(HP)	350
	500 V	(kW)	260
		(HP)	350
	660 / 690 V	(kW)	300
		(HP)	400
Percentage of the max. operational current at	1000 V	(kW)	260
		(HP)	350
	600 ops./h	(%)	100
	1200 ops./h	(%)	75
	(%)	-	
	(%)	-	

Electronic Control Circuit - AC 50/60Hz / DC

Coils with electronic module			CEM112 / 150	CEM180 / 215	CEM250 / 300	CEM450/560
Rated insulation voltage U_i (pollution degree 3)	acc. IEC / VDE 0660	(V)	1000			
	acc. UL / CSA	(V)	600			
Standard voltages		(V)	110-255 V 50/60 Hz / DC			
Voltage Operating limits - acc. IEC 60947-1						
Coil Operating Limits		xU_s	0.8...1.1	0.8...1.1	0.8...1.1	0.8...1.1
	Pick-up	xU_s	0.6 ... 0.75	0.6 ... 0.75	0.6 ... 0.75	0.6 ... 0.75
	Drop-out	xU_s	0.4 ... 0.6	0.4 ... 0.6	0.4 ... 0.6	0.4 ... 0.6
Consumption - AC (at $1,0 \times U_s$ and cold coil)						
Electronic coils (at 60Hz)	Magnetic circuit closed	(VA)	16.3	21.5	35.2	38.5
	Power factor		0.26	0.27	0.26	0.26
	Thermal power dissipation	(W)	4.2	5.8	9.2	10.0
	Magnetic circuit closing	(VA)	322	426	518	700
	Power factor		0.71	0.68	0.73	-
Consumption - DC (at $1,0 \times U_s$ and cold coil)						
Electronic coils at DC	Magnetic circuit closed	(W)	12.5	12.5	12.5	25
	Magnetic circuit closing	(W)	415	375	380	780
Opening and closing times (Values at U_s)						
Between coil energization and:	NO contact closing	(ms)	40...70	40...70	65...85	80...110
Between coil de-energization and:	NO contact opening	(ms)	50...70	55...75	40...65	50...90
Mechanical endurance		ops.	10 million	10 million	10 million	3 million
Maximum rate	No load	ops./h	1000	1000	1000	1000
	AC1 and AC3 at rated power	ops./h	600	600	600	300
	AC4 at rated power	ops./h	150	150	150	150

AC - Utilisation Category for CEM 450-560

Utilisation category AC-4			CEM450	CEM560
Operational current I_e AC-4	$U_e \leq 440$ V	(A)	280	345
	500 V	(A)	211	220
	690 V	(A)	160	195
	1000 V	(A)	100	125
Operational power Three-phase motors (50/60 Hz) (200.000 operations)	220 / 230 V	(kW)	75	90
		(HP)	100	125
	380 / 400 V	(kW)	150	185
		(HP)	200	250
	415 / 440 V	(kW)	150	185
		(HP)	200	250
	500 V	(kW)	130	185
		(HP)	200	250
	660 / 690 V	(kW)	150	185
		(HP)	200	250
	1000 V	(kW)	132	150
		(HP)	175	200
Max. Operational current I_e ($U_e \leq 400$ V) (35.000 operations)		(A)	450	560
Max. Operational power ($U_e \leq 380/400$ V)		(kW)	260	300
Maximum frequency of switching		(ops./h)	350	400

DC - Utilisation Category for CEM450-560

Utilisation category DC-1 (L/R ≤ 1 ms)		CEM450	CEM560
U _c (V)	Poles in serie	Max. Operational current I _c (A)	
24V	1	450	560
	2	600	690
	3	600	690
110V	1	225	280
	2	450	560
	3	600	690
220V	1	45	56
	2	300	345
	3	600	690
440V	1	-	-
	2	150	172
	3	300	345

DC - Utilisation Category for CEM450-560

Utilisation category DC-3 / DC-5 (L/R ≤ 15 ms)		CEM450	CEM560
U _c (V)	Poles in serie	Max. Operational current I _c (A)	
24V	1	350	450
	2	450	560
	3	450	560
110V	1	200	260
	2	350	400
	3	400	450
220V	1	30	35
	2	160	200
	3	300	345
440V	1	-	-
	2	50	65
	3	150	180

Dimensions

	AC/DC
CEM9	A=87
CEM12	A=87
CEM18	A=87
CEM25	A=87

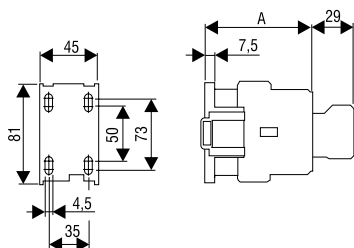

	AC	DC
CEM32	A=98	A=118
CEM40	A=98	A=118

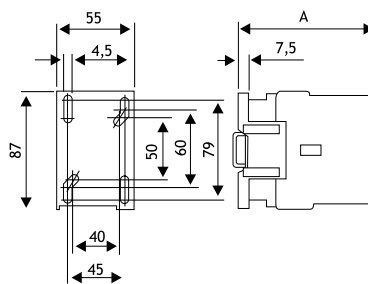

	AC/DC
CEM50	A=116
CEM65	A=116
CEM80	A=116

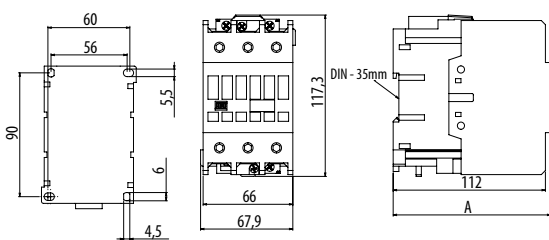

	AC/DC
CEM95	A=126
CEM105	A=126

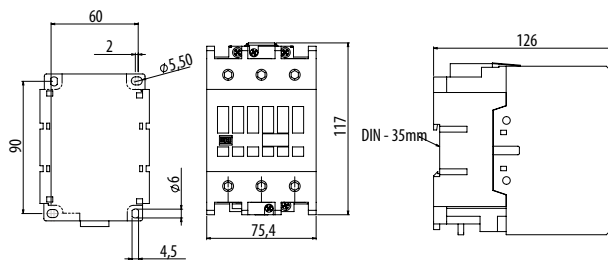

CEM112(E)
CEM150E

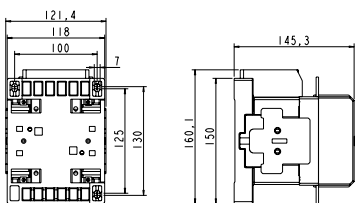

CEM180(E)

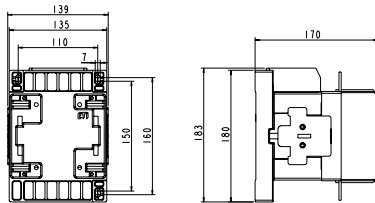

CEM250(E)
CEM300(E)

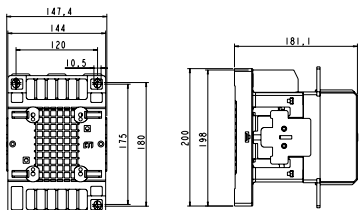

CEM 450(E)
CEM 560(E)

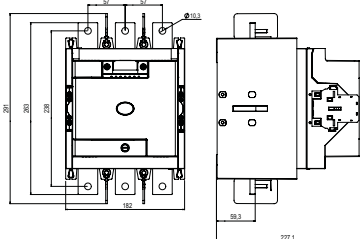

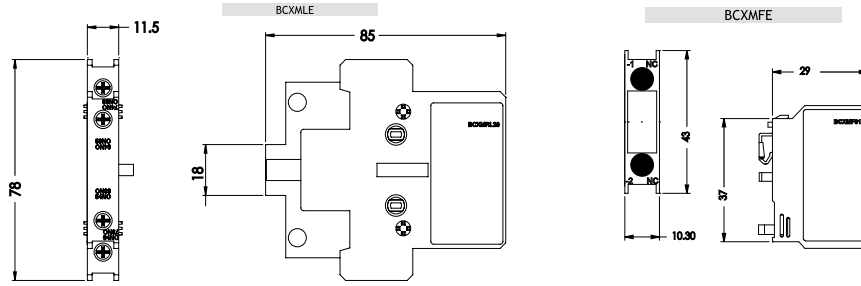

Mounting position

CEM9...105

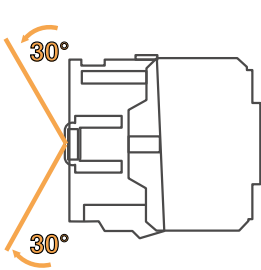

CEM112...300

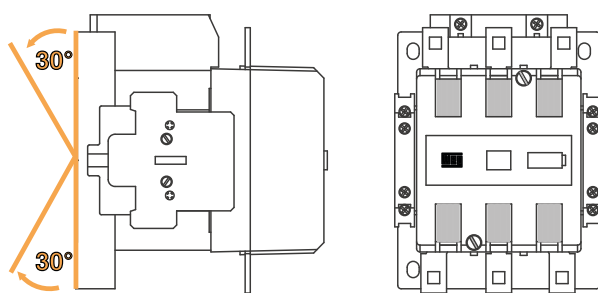

Diagram

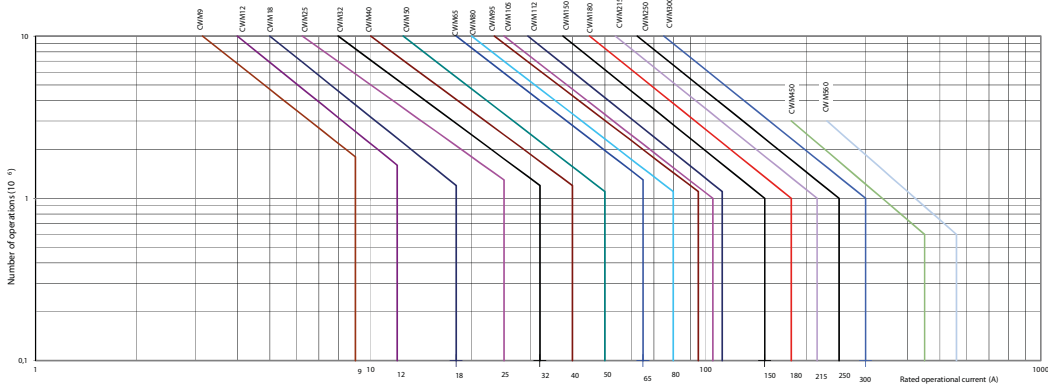
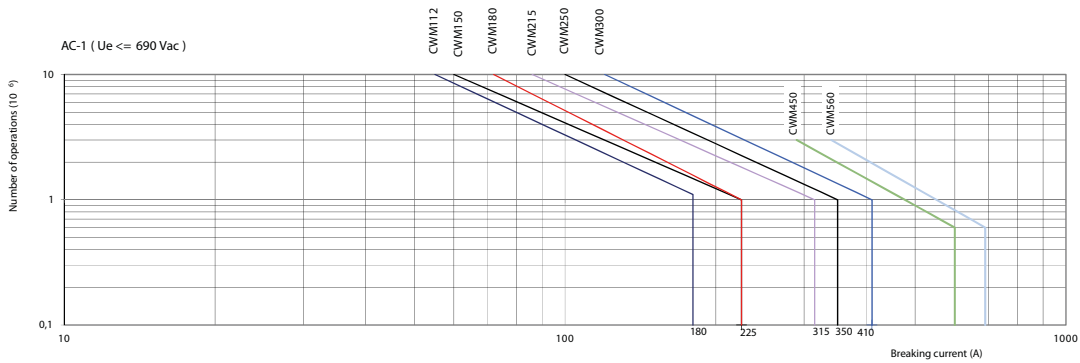

Accessories

Auxiliary contact block - front mounted

Type	Code No.	Description	For use with	Wiring diagram	g	
BCXMF10	004641510	1 NO	CEM9-CEM105		15	1
BCXMF01	004641501	1 NC	CEM9-CEM105		15	1
BCXMF0E10	004642510	1 NO - early-make	CEM9-CEM105		15	1
BCXMF0E01	004643510	1 NC - late-break	CEM9-CEM105		15	1
BCXMF10S*	004646094	Special aux. Contact 1xNO	CEM9-CEM105		15	1
BCXMF01S*	004646095	Special aux. Contact 1xNC	CEM9-CEM105		15	1

not for CEM7,5CN and CEM10CN!

available free aux. contact blocks places:

CEM 9	CEM 40: 4 contact blocks
CEM 50	CEM 105: 6 contact blocks
CEM 112	CEM 300: mounting not available - only lateral, see below

*Special aux. contacts (Au - gold) for low signals switching min. 1mA /17V



Auxiliary contact block - lateral

Type	Code No.	Description	For use with	Wiring diagram	g	
BCXMLE11	004644511	1 NO - 1 NC (main)	CAEM4, CEM9-CEM250		15	1
BCXMLE20	004644520	2 NO (main)	CAEM4, CEM9-CEM250		15	1
BCXMRLE11	004645511	1 NO - 1 NC side mounted (upgraded)	CAEM4, CEM9-CEM250		15	1
BCXMRLE20	004645520	2 NO side mounted (upgraded)	CAEM4, CEM9-CEM250		15	1
BLRBE-11	004656308	1 NO - 1 NC side mounted (upgrade)	CEM450-CEM560		34	1
BLBE-11	004656325	1 NO - 1 NC side mounted (spare part)	CEM450-CEM560		34	1

not for CEM7,5CN and CEM10CN!

Main* lateral auxiliary contact block can be mounted on the front side of the contactor, it can be upgraded max. with one additional auxiliary contact block.



Max. number of auxiliary contacts together

(top and side mounted):
 max. 4: CEM9-CEM25, CAEM 4
 max. 6: CEM32-CEM40
 max. 8: CEM50-CEM105
 max. 8: CEM112-CEM300





Mechanical interlock

Type	Code No.	For use with	 g	
BLIME 9-105	004643601	CEM9-CEM105	50	1
BLIME9-105 02*	004646093	CEM9-CEM105	69	1
BLIME 112-300E	004643602	CEM112(E)-CEM560(E)	150	1

*Mechanical interlock with integrated auxiliary contacts 2xNC

Dimensions

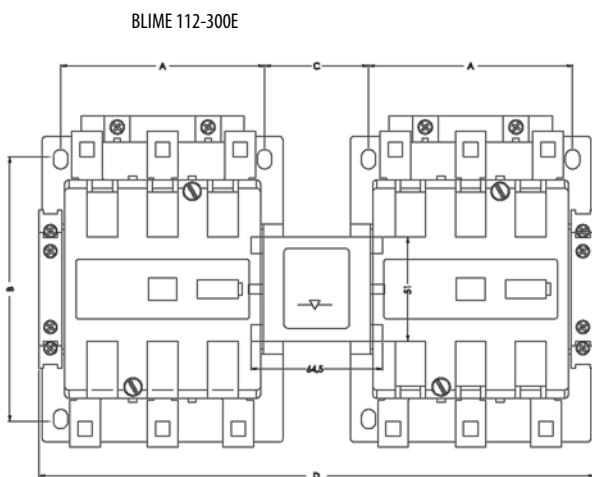
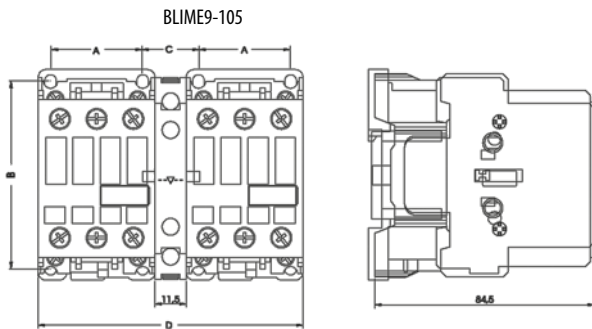

Contactors	A	B	C	D
CEM112...150	100	130	51	272,5
CEM180	110	160	58,5	303,5
CEM250...300	120	180	57	325,4
CEM250...300	175	196	57	414

Contactors	A	B	C	D
CEM9...25	35	72,5	22	102
CEM32...40	45	79	22	122
CEM50...80	57	90	22	144
CEM95...105	57	90	29	162

Mechanical interlocks BLIME: Contactor sizes & compatibility



Contactor	Same size Q1=Q2
BLIME 9-105	004643601 CEM9...CEM105
BLIME 112-300E	004643602 CEM112(E)-CEM300(E)

AC coils	Different size	
	Q1	Q2
BLIME 9-105	004643601 CEM9...CEM105	CEM9...CEM105
BLIME 112-300E	004643602 CEM112...CEM150	CEM112...CEM150
		CEM250...300 CEM250...300



DC coils	Different size	
	Q1	Q2
BLIME 9-105	004643601 CEM9...18	CEM9...18
BLIME 9-105	004643601 CEM32...40	CEM32...40
BLIME 9-105	004643601 CEM50...CEM105	CEM50...CEM105

AC&DC coils	Different coil	
	C1	C2
BLIME 9-105	004643601 CEM50...105 DC coil	CEM9...105 AC coil



Surge suppressor

Type	Code No.	Coil voltage	For use with		
BAMRCE4	004642701	24-48 VAC	CEM9-CEM40	14	1
BAMRCE5	004642702	50-127 VAC	CEM9-CEM40	14	1
BAMRCE6	004642703	130-250 VAC	CEM9-CEM40	14	1
BAMRCE7	004642705	24-48 VAC	CEM50-CEM105	14	1
BAMRCE8	004642706	50-127 VAC	CEM50-CEM105	14	1
BAMRCE9	004642707	130-250 VAC	CEM50-CEM105	14	1
BAMDIE10	004643701	12-600 VDC	CEM9-CEM105	14	1
BAMRCE13	004642708	24-48 VAC	CEM112-CEM250	14	1
BAMRCE14	004642711	50-250 VAC	CEM112-CEM250	14	1
BAMVE5 255V/ACDC	004656320	100-255VAC	CEM450E-CEM560E	18	1

**Terminal blocks**



Type	Code No.	For use with		
TBE150	004646090	CEM112...CEM150	210	1
TBE180	004646091	CEM180	270	1
TBE300	004646092	CEM250...CEM300	575	1

**Spare contacts***

Type	Code No.	For use with		
SCCEM450	004656323	CEM450(E)	1120	1
SCCEM560	004656324	CEM560(E)	1120	1

*1(pc) reference code includes 3 spare contacts (1 pc = 3 spare contacts -> 3 moving parts and 6 fixed parts)

**Terminal cover**

Type	Code No.	For use with		
CCEM150	004646080	CEM112...CEM150	231	1
CCEM180	004646081	CEM180	231	1
CCEM300	004646082	CEM250...CEM300	231	1
CCEM560	004656309	CEM450...CEM560	231	1

*1(pc) reference code includes 2 covers (1pc=top+bottom)



Overload relay

- // phase-failure sensitivity to IEC/EN 60947-4-1, DIN VDE 0660T.102
- // tripping class 10 according to standard 60947-4-1
- // temperature compensation
- // auxiliary contact 1NO/1NC
- // hand/auto/reset

PIN from auxiliary contactor



Overload relay RE27D

Type	Code No.	Current setting range [A]	For use with		
RE27D-0,4	004642400	0,28-0,4			
RE27D-0,63	004642401	0,4-0,63			
RE27D-0,8	004642402	0,56-0,8			
RE27D-1,2	004642403	0,8-1,2			
RE27D-1,8	004642404	1,2-1,8			
RE27D-2,8	004642405	1,8-2,8			
RE27D-4,0	004642406	2,8-4,0	CEM09		
RE27D-6,3	004642407	4-6,3	...	147	1
RE27D-8,0	004642408	5,6-8	CEM25		
RE27D-10	004642409	7-10			
RE27D-12,5	004642410	8-12,5			
RE27D-15	004642411	10-15			
RE27D-17	004642412	11-17			
RE27D-23	004642413	15-23			
RE27D-32	004642414	22-32			



Overload relay RE67.1D



Type	Code No.	Current setting range [A]	For use with		
RE67.1D-40	004643415	25-40	CEM32...	300	1
RE67.1D-50	004643416	32-50	CEM40		





Overload relay RE67.2D

Type	Code No.	Current setting range [A]	For use with		
RE67.2D-57	004644417	40-57	CEM50		
RE67.2D-63	004644418	50-63	...	310	1
RE67.2D-70	004644419	57-70	CEM80		
RE67.2D-80	004644420	63-80			



Overload relay RE117.1D

Type	Code No.	Current setting range [A]	For use with		
RE117.1D-97	004645421	75-97	CEM95...	520	1
RE117.1D-112	004645422	90-112	CEM105		

**Overload relay RE117.2D**



Type	Code No.	Current setting range [A]	For use with		
RE117.2D-97	004646421	75-97		550	1
RE117.2D-112	004646422	90-112	CEM112(E)		

**Overload relay RE317.2D**

Type	Code No.	Current setting range [A]	For use with		
RE317D-150	004647423	100-150	CEM150(E)		
RE317D-215	004647424	140-215	...	900	1
RE317D-310	004647425	200-310	CEM250(E)		
RE317D-420	004656312	275-420	CEM450(E)	2000	





Overload relay RE407D

Type	Code No.	Current setting range [A]	For use with		
RE407D-600	004656313	400-600	CEM560(E)	3600	1





Overload relay connection bars

Type	Code No.	For use with		
GAE317-11D	004656310	CEM450(E)+RE317D-420	253	1
GAE407-1D	004656311	CEM560(E)+RE407D-600	461	1

*1(pc) reference code includes 3 bars for one 3 pole connection



Overload relay mounting kits for rails TH35

Type	Code No.	For use with		
BF27D	004641901	RE27D	50	1
BF67.1D	004641902	RE67.1,	95	1
BF67.2D	004641904	RE67.2	95	1
BF117D	004641903	RE117.1D	110	1



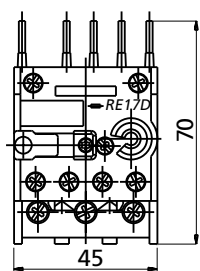

RE17D

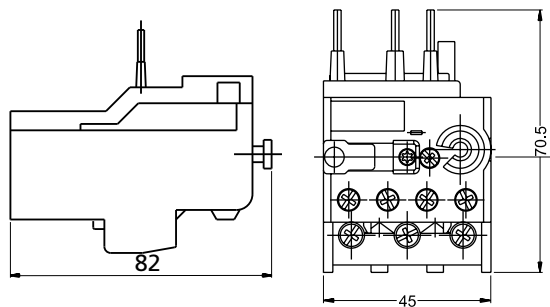

RE27D

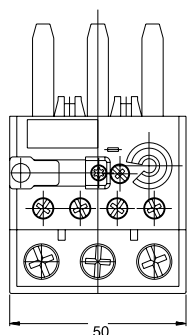

RE67D

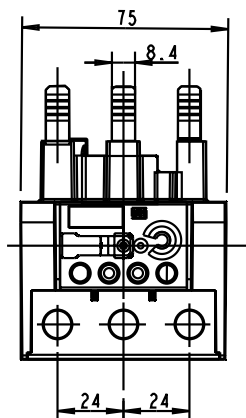
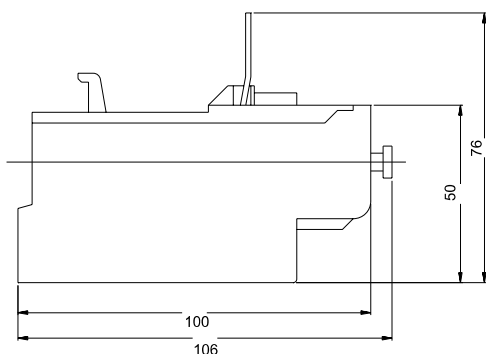

RE117.1D

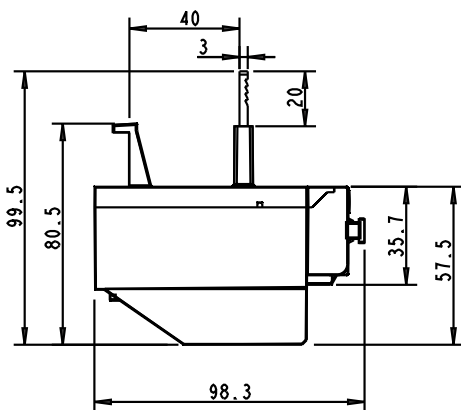

RE Thermal Overload Relays in Contactor Assemblies for Wye-Delta Starters

When using thermal overload relays in conjunction with contactor assemblies for wye-delta starters, it should be taken into consideration that only $0.58 (\sqrt{3} / 3) \times$ the motor current flows through the main contactor. An overload relay mounted on the main contactor must be set to the same multiple of the motor current.

A second overload relay may be mounted on the wye contactor if it is desired the load to be optimally protected in wye operation. The wye current is $1/3$ of the rated motor current. The relay must then be set to this current.

Protection Against Short-Circuit

The RE thermal overload relays must be protected against short-circuits by fuses or circuit breakers.

Ambient Air Temperature Compensation

RE thermal overload relays are temperature compensated. Its trip point is not affected by temperature, and it performs consistently at the same value of current. The time-current characteristics of REs refer to a stated value of ambient air temperature within the range of $-20\text{ }^{\circ}\text{C}$ to $+60\text{ }^{\circ}\text{C}$ and are based on no previous loading of the overload relay (i.e. from an initial cold state). For ambient air temperature within the range of $+60\text{ }^{\circ}\text{C}$ up $+80\text{ }^{\circ}\text{C}$ (maximum ambient air temperature), the current correction factor shown in the table below should be applied:

Ambient air temperature [°C]	Current correction factor
65	0,94
70	0,87
75	0,81
80	0,73

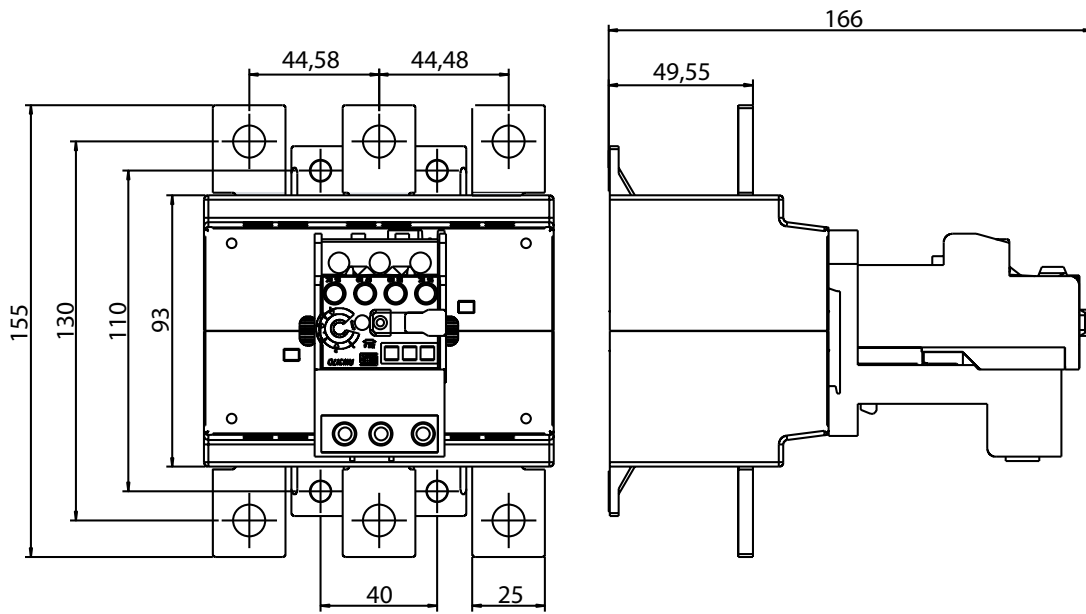

RE317D

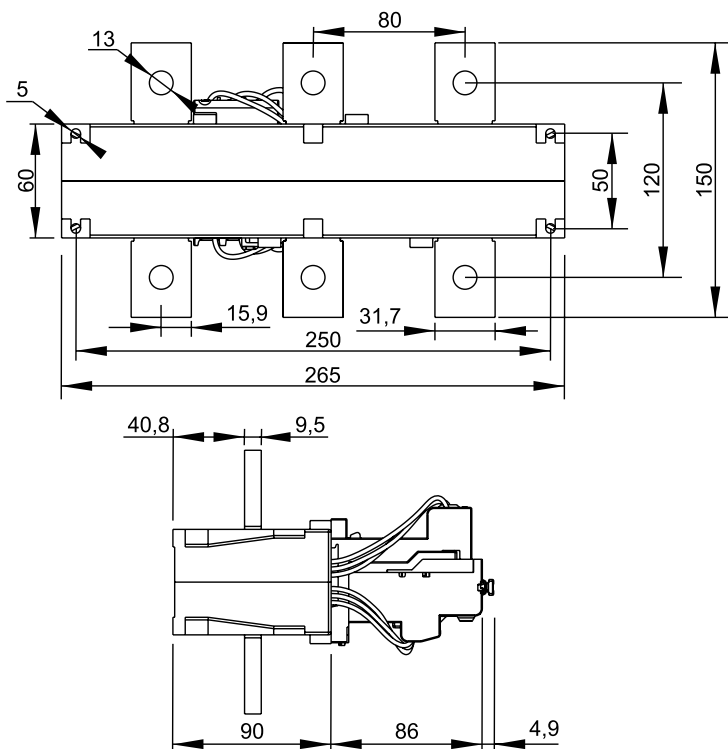

RE407D

overload relay current setting	recommended fuse gG (A)
0,28-0,4	2
0,4-0,63	2
0,56-0,8	2
0,8-1,2	4
1,2-1,8	6
1,8-2,8	6
2,8-4	10
4-6,3	16
5,6-8	20
7-10	25
8-12,5	25
10-15	35
11-17	35
15-23	50
22-32	63
25-40	80
32-50	100
40-57	100
50-63	100
57-70	125
63-80	125
75-97	200
90-112	250
100-150	315
140-215	355
200-310	500
275-420	710
400-600	1000

CEM450E/560E + RE317D (200...420A)

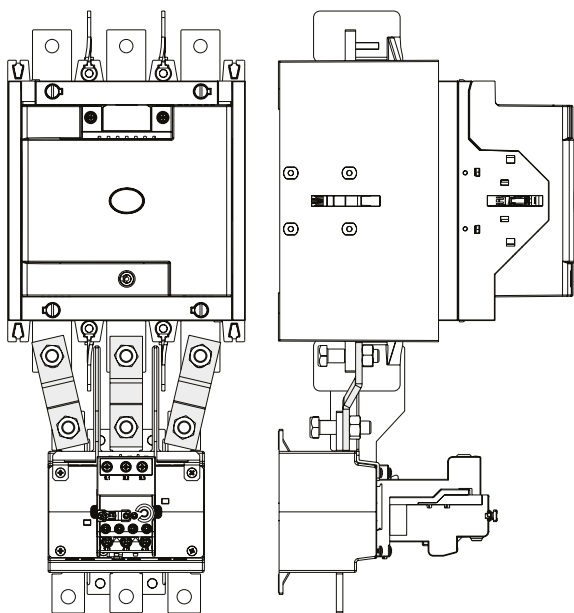

CEM450E/560E + RE407D (400...600A)

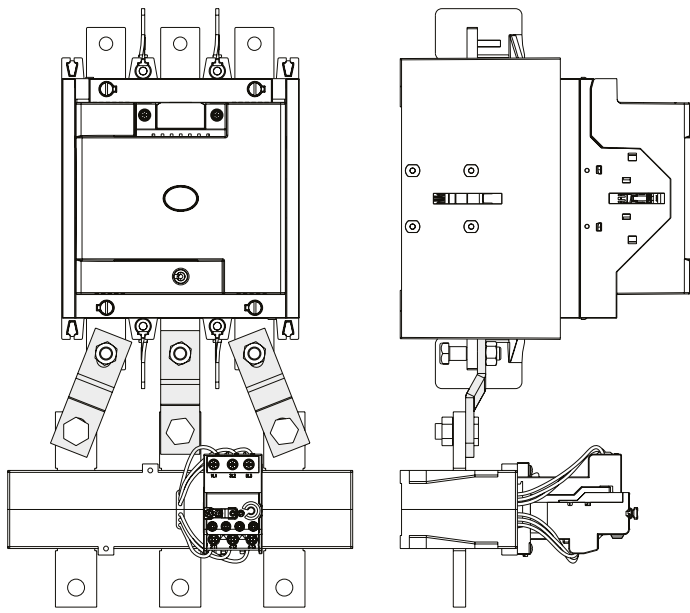

Mounting position for RE17D to RE117D

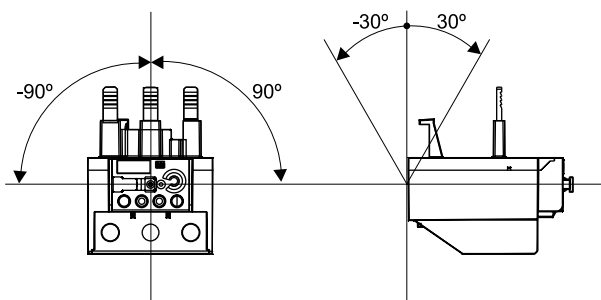

RE...D Tripping characteristic

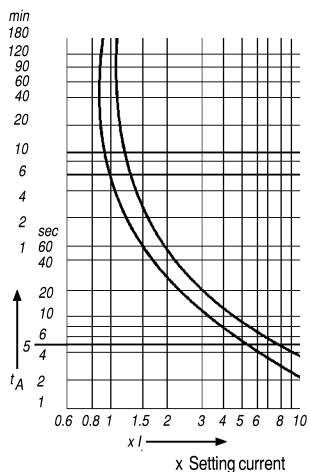

These tripping characteristics show mean values of the tolerance range at 20°C ambient temperature starting from cold. They show the tripping times in relation to the response current. At operational temperature, the tripping time of the overload relay drops to approximately 25 % of the shown.

Overload relay

Type		RE17D	RE27D	RE67D	RE117D	RE317D	RE407D
General technical data							
Standards		IEC/EN 60 947, DIN VDE 0660					
Current setting	(A)	0,28 - 17	0,28 - 32	25 - 80	75 - 112	100 - 420	400 - 840
Tripping Class acc. to IEC 60947-4-1		10					
Temperature compensation		continuous					
Rated insulation voltage Ui acc. IEC/EN 60 947/DIN VDE 0660	(V)	690			1000		
Rated impulse withstand voltage Uimp	(kV)	6			8		
Rated operational frequency	(Hz)	0 - 400			50/60		
Degree of protection		IP 20					
Protection against direct contact from the front when actuated by a perpendicular test finger (IEC 536)		finger and back-of-hand proof					
Ambient temperature							
Operating temperature	°C	-25 ... +60					
Storage temperature	°C	-40 ... +70					
Power dissipation (value of setting range)	lower	(W)	0,9	1,5	2,3	1	
	higher	(W)	1,4	1,7	4,7	1,9	
Aux. Contacts impedance (pole)	mR	2,5					
Terminal capacity							
solid	mm ²	2x 1,5 - 6		1x 6 - 35	1x 25 - 35	2x35-120 (100-215A) 2x95-150 (200-420A)	-
flexible without cable	mm ²	2x 1,5 - 6		1x 6 - 35	1x 25 - 35	2x35-120 (100-215A) 2x95-150 (200-420A)	-
flexible with cable lug	mm ²	2x 1,5 - 6		1x 6 - 35	1x 25 - 35	2x35-120 (100-215A) 2x95-150 (200-420A)	-
stranded	mm ²	2x 1,5 - 10		1x 6 - 35	1x 25 - 35	2x35-120 (100-215A) 2x95-150 (200-420A)	-
busbar	mm	-		-	-	max 2x (25 x 5)	max 2x (60 x 10)
Tightening torque	Nm	2,3		4	6	141 (100-215A) 230 (200-420A)	230
Auxiliary contacts							
Rated insulation voltage Ui acc. IEC/EN 60 947/DIN VDE 0660	(V)	690					
Rated operational voltage Ue	(V)	690					
Rated thermal current Ith	(A)	6					
Rated operational current le AC-15	24 V	(A)	4				
	60 V	(A)	3,5				
	125 V	(A)	3				
	230 V	(A)	2				
	400 V	(A)	1,5				
	500 V	(A)	0,5				
Rated operational current le DC-13	690 V	(A)	0,3				
	24 VDC	(A)	1				
	60 VDC	(A)	0,5				
	110 VDC	(A)	0,25				
Terminal capacity	220 VDC	(A)	0,1				
	Terminal screw		M3,5 x 10 Philips				
	Cable size	mm ²	2 x 1-2,5				
Terminal capacity	AWG-wire		16-12				
	Tightening torque	Nm	1,5				

Minimum fuse size for the protection of three-phase motors.**The maximum size is governed by the requirements of the associated switchgear or overload relay.**

Motor rating			230 V				400 V				500 V				690 V			
			Rated motor current		Fuse		Rated motor current		Fuse		Rated motor current		Fuse		Rated motor current		Fuse	
			[kW]	cosφ	η(%)	[A]	Starting direct	Y/Δ	[A]	Starting direct	Y/Δ	[A]	Starting direct	Y/Δ	[A]	Starting direct	Y/Δ	
0,06	0,7	58	0,37	2	-	0,21	2	-	0,17	2	-	0,12	2	-				
0,09	0,7	60	0,54	2	-	0,31	2	-	0,25	2	-	0,18	2	-				
0,12	0,7	60	0,72	4	2	0,41	2	-	0,3	2	-	0,24	2	-				
0,18	0,7	62	1,04	4	2	0,6	2	-	0,48	2	-	0,35	2	-				
0,25	0,7	62	1,4	4	2	0,8	4	2	0,7	2	-	0,5	2	-				
0,37	0,72	66	2	6	4	1,1	4	2	0,9	2	2	0,7	2	-				
0,55	0,75	69	2,7	10	4	1,5	4	2	1,2	4	2	0,9	4	2				
0,75	0,79	71	3,2	10	4	1,9	6	4	1,5	4	2	1,1	4	2				
1,1	0,81	74	4,6	10	6	2,6	6	4	2,1	6	4	1,5	4	2				
1,5	0,81	74	6,3	16	10	3,6	6	4	2,9	6	4	2,1	6	4				
2,2	0,81	78	8,7	20	10	5	10	6	4	10	4	2,9	10	4				
3	0,82	80	11,5	25	16	6,6	16	10	5,3	16	6	3,8	10	4				
4	0,82	83	14,8	32	16	8,5	20	10	6,8	16	10	4,9	16	6				
5,5	0,82	86	19,6	32	25	11,3	25	16	9	20	16	6,5	16	10				
7,5	0,82	87	26,4	50	32	15,2	32	16	21,1	25	16	8,8	20	10				
11	0,84	87	38	80	40	21,7	40	25	17,4	32	20	12,6	25	16				
15	0,84	88	51	100	63	29,3	63	32	23,4	50	25	17	32	20				
18,5	0,84	88	63	125	80	36	63	40	28,9	50	32	20,9	32	25				
22	0,84	92	71	125	80	41	80	50	33	63	32	23,8	50	25				
30	0,85	92	96	200	100	55	100	63	44	80	50	32	63	32				
37	0,86	92	117	200	125	68	125	80	54	100	63	39	80	50				
45	0,86	93	141	250	160	81	160	100	65	125	80	47	80	63				
55	0,86	93	173	250	200	99	200	125	79	160	80	58	100	63				
75	0,86	94	233	315	250	134	200	160	107	200	125	78	160	100				
90	0,86	94	279	400	315	161	250	200	129	200	160	93	160	100				
110	0,86	94	342	500	400	196	315	200	157	250	160	114	200	125				
132	0,87	95	401	630	500	231	400	250	184	250	200	134	250	160				
160	0,87	95	486	630	630	279	400	315	224	315	250	162	250	200				
200	0,87	95	607	800	630	349	500	400	279	400	315	202	315	250				
250	0,87	90	-	-	-	437	630	500	349	500	400	253	400	315				
315	0,87	96	-	-	-	544	800	630	436	630	500	316	500	400				
400	0,88	96	-	-	-	683	1000	800	547	800	630	396	630	400				
450	0,88	96	-	-	-	769	100	800	615	800	630	446	630	630				
500	0,88	97	-	-	-	-	-	-	-	-	-	491	630	630				
560	0,88	97	-	-	-	-	-	-	-	-	-	550	800	630				
630	0,88	97	-	-	-	-	-	-	-	-	-	618	800	630				

The rated motor currents apply to normal, internal-ventilated and enclosed fan-cooled three-phase motors at 1500 rpm.

D.O.L. Starting: Maximum starting current 6 x rated motor current. Maximum starting time 5 seconds.

Y/D-starting: Maximum starting current 2 x rated motor current. Maximum starting time 15 seconds.

Set the overload relay in the phase lead to 0,58 x rated motor current.

Rated fuse currents for Y/D-starting also apply to three-phase motors with slip-ring rotors.

Use a larger fuse if the rated current or starting current is higher and/or if the starting time is longer.

The table applies to "slow" or "gL" fuse (VDE 0636)

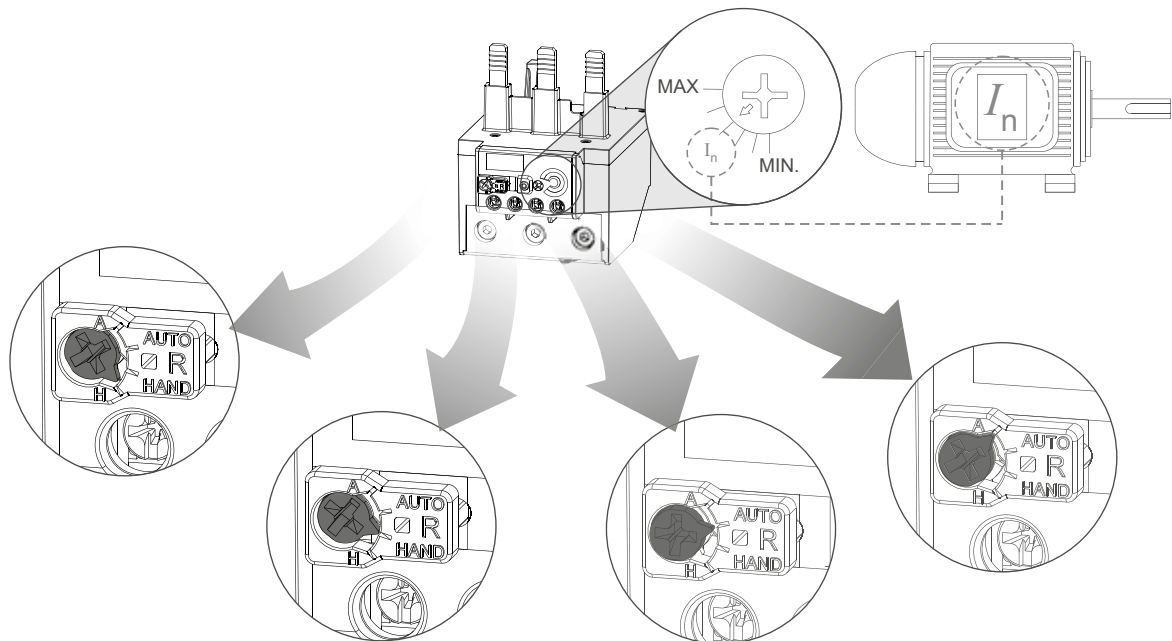

By NH fuse with aM characteristics, select fuse size to match rated current.



97-98 NO				
	MANUAL RESET - Device must be reset manually after overload by pushing the button. Relay must cool down before reset.	MANUAL RESET AND TEST - Device must be reset manually after overload by pushing the button. Relay must cool down before reset.	AUTOMATIC RESET AND TEST - Automatic reset of thermal protection, after cool down. - Test circuit is available.	AUTOMATIC RESET - Automatic reset of thermal protection, after cool down. - Testing not available in this mode.
95-96 NC				
	- Testing not available in this mode.	- Test function available in this mode.		

4 Pole Motor Contactors



4 pole motor contactors

Type	Code No.	Rated current AC3 [A]	Rated current AC1 [A]	 g	
CEB10.00-230V-50/60HZ*	002462000	10	25	260	1/66
CEB14.00-230V-50/60HZ*	002462001	14	25	260	1/66
CEB18.00-230V-50/60HZ*	002462002	18	32	260	1/66
CEB22.00-230V-50/60HZ*	002462003	22	32	260	1/66
CEB24.00-230V-50/60HZ*	002462004	24	50	610	1/28
CEB32.00-230V-50/60HZ*	002462005	32	65	610	1/28
CEB40.00-230V-50/60HZ*	002462006	40	80	610	1/28
CEB50.00-230V-50/60HZ**	002462007	50	110	1060	1/16
CEB62.00-230V-50/60HZ**	002462008	62	120	1060	1/16
CEB74.00-230V-50/60HZ**	002462009	74	130	1060	1/16



*max 4 additional aux. Contacts top (front) mounted (BCF or BCFE)

**max 6 additional aux. Contacts top (front) mounted (BCF or BCFE) and 2 side mounted BCS



Aux. Contact block - top (front) mounted

Type	Code No.	For use with	AC15 [A]	Wiring diagram	 g	
CEB-BCFE 10	002462100	CEB10...CEB74	3	1NO	111	10/1020
CEB-BCFE 01	002462101	CEB10...CEB74	3	1NC	111	10/1020
CEB-BCF 10	002462102	CEB10...CEB74	6	1NO	180	10/800
CEB-BCF 01	002462103	CEB10...CEB74	6	1NC	180	10/800

Aux. Contact block - side mounted

Type	Code No.	For use with	AC15 [A]	Wiring diagram	 g	
CEB-BCS1 11	002462104	CEB10...CEB22	6	1NO+1NC	330	10/160
CEB-BCS2 11	002462105	CEB24...CEB74	6	1NO+1NC	330	10/160
CEB-BCS2 02	002462106	CEB24...CEB74	6	2NC	310	10/160

Mechanical interlock for mechanical locking of contactors (ATS systems...)

Type	Code No.	For use with	 g	
CEB-MIL 10-40	002462107	CEB10...CEB40	10	10/100
CEB-MIL 50-74	002462108	CEB50...CEB74	23	10/50

Data according to IEC 947-4-1, EN 60947-4-1, VDE 0660

Main Contacts		Type	CEB10.00	CEB14.00	CEB18.00	CEB22.00	CEB24.00	CEB32.00	CEB40.00	CEB50.00	CEB62.00	CEB74.00
Rated insulation voltage U_i ¹⁾		V AC	690	690	690	690	690	690	690	830	830	830
Making capacity I_{eff} at $U_e = 690V$ AC		A	200	200	200	200	400	500	500	700	900	900
		1000V AC	-	-	-	-	-	-	-	-	-	-
Breaking capacity I_{eff}		400V	180	200	200	200	380	400	400	600	800	800
CEB10 to CEB22 $\cos\phi = 0,65$		500V AC A	150	150	180	180	300	370	370	500	700	700
CEB24 to CEB74 $\cos\phi = 0,35$		690V AC A	100	100	150	150	260	340	340	400	500	500
		1000V AC A	-	-	-	-	-	-	-	-	-	-
Utilization category AC1												
Switching of resistive load												
Rated operational current $I_o (=I_{tr})$ at 40°C, open		690V A	25	25	32	32	50	65	80	110	120	130
Rated operational power		220V kW	9,5	9,5	12,2	12,2	19,0	24,7	30,4	41,9	45,7	49,5
of three-phase resistive loads		230V kW	9,9	9,9	12,7	12,7	19,9	25,9	31,8	43,8	47,7	51,7
50-60Hz, $\cos\phi = 1$		240V kW	10,4	10,4	13,3	13,3	20,8	27,0	33,2	45,7	49,8	54,0
		380V kW	16,4	16,4	21,0	21,0	32,9	42,7	52,6	72,3	78,9	85,5
		400V kW	17,3	17,3	22,1	22,1	34,6	45,0	55,4	76,1	83,0	90,0
		415V kW	17,9	17,9	23,0	23,0	35,9	46,7	57,4	79,0	86,2	93,3
		440V kW	19,0	19,0	24,4	24,4	38,1	49,5	60,9	83,7	91,3	99,0
		500V kW	21,6	21,6	27,7	27,7	43,3	56,2	69,2	95,2	103,8	112,5
		660V kW	28,5	28,5	36,5	36,5	57,1	74,2	91,3	125,6	137,0	148,4
		690V kW	29,8	29,8	38,2	38,2	59,7	77,6	95,5	131,3	143,2	155,2
		1000V kW	-	-	-	-	-	-	-	-	-	-
Rated operational current $I_o (=I_{tr})$ at 40°C, inside the enclosure 60°C		690V A	25	25	32	32	40	55	65	90	100	110
Rated operational power		220V kW	9,5	9,5	12,2	12,2	15,2	20,9	24,7	34,3	38,1	41,9
of three-phase resistive loads		230V kW	9,9	9,9	12,7	12,7	15,9	21,9	25,9	35,8	39,8	43,8
50-60Hz, $\cos\phi = 1$		240V kW	10,4	10,4	13,3	13,3	16,6	22,8	27,0	37,4	41,5	45,7
		380V kW	16,4	16,4	21,0	21,0	26,3	36,2	42,7	59,2	65,7	72,3
		400V kW	17,3	17,3	22,1	22,1	27,7	38,1	45,0	62,3	69,2	76,1
		415V kW	17,9	17,9	23,0	23,0	28,7	39,5	46,7	64,6	71,8	79,0
		440V kW	19,0	19,0	24,4	24,4	30,4	41,9	49,5	68,5	76,1	83,7
		500V kW	21,6	21,6	27,7	27,7	34,6	47,6	56,2	77,9	86,5	95,2
		660V kW	28,5	28,5	36,5	36,5	45,7	62,8	74,2	102,8	114,2	125,6
		690V kW	29,8	29,8	38,2	38,2	47,7	65,7	77,6	107,4	119,4	131,3
		1000V kW	-	-	-	-	-	-	-	-	-	-
Minimum cross-section of conductor at load with $I_o (=I_{tr})$		mm ²	4	4	6	6	10	16	25	35	50	50
Utilization category AC2 and AC3												
Switching of three-phase motors												
Rated operational current I_o open and enclosed		220V A	12	15	18	22	24	32	40	50	63	74
		230V A	11,5	14,5	18	22	24	32	40	50	62	74
		240V A	11	14	18	22	24	32	40	50	62	74
380-400V		A	10	14	18	22	24	32	40	50	62	74
		415V A	9	14	18	22	23	30	40	50	62	74
		440V A	9	14	18	22	23	30	40	50	62	74
		500V A	8,9	11,9	15	15	22,5	28,5	28,5	44	54	64,5
		660-690V A	6,7	9	12	12	17,5	21	21	33	42	49
		1000V A	-	-	-	-	-	-	-	-	-	-
Rated operational power of three-phase motors 50-60Hz		220-230V kW	3	4	5	6	6	8,5	11	12,5	18,5	22
		240V kW	3	4	5	7	7	9	11,5	13,5	19	23
		380-400V kW	4	5,5	7,5	11	11	15	18,5	22	30	37
		415V kW	4,5	6	8,5	12	12	16	20	24	33	40
		440V kW	4,5	6	8,5	12	12	16	20	24	33	40
		500V kW	5,5	7,5	10	10	15	18,5	18,5	30	37	45
		660-690V kW	5,5	7,5	10	10	15	18,5	18,5	30	37	45
		1000V kW	-	-	-	-	-	-	-	-	-	-

1) Suitable at 690V for: earthed-neutral systems, overvoltage category I to IV, pollution degree 3 (standard-industry): $U_{imp} = 8kV$. Data for other conditions on request.

Contactors

Data according to IEC 947-4-1, EN 60947-4-1, VDE 0660

Main Contacts		Type	CEB10.00	CEB14.00	CEB18.00	CEB22.00	CEB24.00	CEB32.00	CEB40.00	CEB50.00	CEB62.00	CEB74.00
Utilization category AC4												
Switching of squirrel cage motors, inching												
Rated operational current I_e	220V	A	12	15	18	18	24	30	40	50	63	63
open and enclosed	230V	A	11,5	14,5	18	18	24	30	40	50	62	62
	240V	A	11	14	18	18	24	32	40	50	62	62
	380-400V	A	10	14	18	18	24	32	40	50	62	62
	415V	A	9	14	18	18	23	30	37	45	60	60
	440V	A	9	14	18	18	23	30	37	45	55	55
	500V	A	9	12	16	16	17,5	21	21	33	42	42
	660V	A	7	9	9	9	17	20	20	31	40	40
	690V	A	6,5	8,5	8,5	8,5	17	20	20	31	40	40
	1000V	A	-	-	-	-	-	-	-	-	-	-
Rated operational power of three-phase motors 50-60Hz	220-230V	kW	3	4	5	5	6	8,5	11	12,5	18,5	18,5
	240V	kW	3	4	5	5	7	9	11,5	13,5	19	19
	380-400V	kW	4	5,5	7,5	7,5	11	15	18,5	22	30	30
	415V	kW	4,5	6	8,5	8,5	12	16	20	24	33	33
	440V	kW	4,5	6	8,5	8,5	12	16	20	24	33	33
	500V	kW	5,5	7,5	10	10	15	18,5	18,5	30	37	37
	660-690V	kW	5,5	7,5	10	10	15	18,5	18,5	30	37	37
	1000V	kW	-	-	-	-	-	-	-	-	-	-
Utilization category AC5a												
Switching of gas discharge lamps												
Rated operational current I_e per pole at 220/230V												
Fluorescent lamps, uncompensated and serial compensated	A	20	20	25	25	40	52	64	88	96	104	
parallel compensated	A	7	9	9	9	18	22	22	30	40	40	
dual-connection	A	22,5	22,5	28	28	45	58	72	98	108	117	
Metal halide lamps ¹⁾ , uncompensated	A	12	15	19	19	30	39	48	66	72	78	
parallel compensated	A	7	9	9	9	18	22	22	30	40	40	
Mercury-vapour lamps ²⁾ , uncompensated	A	22,5	25	28	28	45	58	72	99	108	117	
parallel compensated	A	7	9	9	9	18	22	22	30	40	40	
Mixed light lamps ³⁾	A	20	20	25	25	40	52	64	88	96	104	
LED-Lamps												
consider the inrush current of the lamp ballast and $\cos\phi$ of the lamp.												
max inrush current of contactor	A	282	282	282	282	564	705	705	987	1269	1268	
$\text{max. lamps per pole } (I_{rLED} \leq I_{rn}) = \frac{\text{inrush current of contactor}}{\text{inrush current of lamp/EVG}}$												
Utilization category AC5b												
Switching of incandescent lamps⁴⁾												
Rated operational current I_e per pole at 220/230V	A	12,5	12,5	12,5	12,5	25	31	31	43	56	56	

1) Metal halide lamps and sodium-vapour lamps (high- and low-pressure lamps)

2) High-pressure lamps

3) Blended lamps, containing a mercury high-pressure unit and a tungsten helix in a fluorescent glass bulb (daylight lamps)

4) Current inrush approx. $16 \times I_e$

Utilization category DC1 Switching of resistive load			CEB10.00	CEB14.00	CEB18.00	CEB22.00	CEB24.00	CEB32.00	CEB40.00	CEB50.00	CEB62.00	CEB74.00
Time constant L/R ≤ 1ms												
Rated operational current I _o 1 pole	24V - 60V	A	20	25	32	32	50	65	80	110	120	130
	110V	A	6	6	6	6	10	10	10	12	12	12
	220V	A	0,8	0,8	0,8	0,8	1,4	1,4	1,4	1,4	1,4	1,4
2 poles in series	24V - 110V	A	20	25	32	32	50	65	80	110	120	130
	220V	A	6	6	6	6	10	10	10	12	12	12
3 poles in series	24V - 110V	A	20	25	32	32	50	65	80	110	120	130
	220V	A	16	20	20	20	30	35	35	63	80	80
Utilization category DC3 and DC5 Switching of shunt motors and series motors												
Time constant L/R ≤ 15ms												
Rated operational current I _o 1 pole	24V	A	20	25	32	32	50	65	80	110	120	130
	60V	A	6	6	6	6	30	30	30	60	60	60
	110V	A	1,2	1,2	1,2	1,2	1,8	1,8	1,8	1,8	1,8	1,8
	220V	A	0,2	0,2	0,2	0,2	0,2	0,2	0,2	0,25	0,25	0,25
2 poles in series	24V - 60V	A	20	25	32	32	50	65	80	110	120	130
	110V	A	6	6	6	6	30	30	30	60	60	60
	220V	A	1,2	1,2	1,2	1,2	1,8	1,8	1,8	1,8	1,8	1,8
3 poles in series	24V	A	20	25	32	32	50	65	80	110	120	130
	60V	A	20	25	32	32	40	40	40	80	80	80
	110V	A	20	20	20	20	40	40	40	80	80	80
	220V	A	2,5	2,5	2,5	2,5	4	4	4	5	5	5

			CEB10.00	CEB14.00	CEB18.00	CEB22.00	CEB24.00	CEB32.00	CEB40.00	CEB50.00	CEB62.00	CEB74.00
Control Circuit Power consumption of coils												
AC operated	inrush	VA		33-45				90-115			140-165	
	sealed	VA		7-10				9-13			13-18	
		W		2,6-3				2,7-4			5,4-7	
Operation range of coils in multiples of control voltage U _s												
AC operated				0,85-1,1				0,85-1,1			0,85-1,1	
				0,8-1,1				0,8-1,1			0,8-1,1	
Switching time at control voltage U_s ± 10%^{2) 3)}												
AC operated	make time	ms		8-16				10-25			12-28	
	release time	ms		5-13				8-15			8-15	
	arc duration	ms		10-15				10-15			10-15	
Cable cross-section												
Magnet coil	solid	mm ²		0,75-2,5				0,75-2,5			0,75-2,5	
	flexible	mm ²		0,5-2,5				0,5-2,5			0,5-2,5	
	flexible with multicore cable end	mm ²		0,5-1,5				0,5-1,5			0,5-1,5	
Clamps per pole				2				2			2	

Accessories

Data according to IEC 947-5-1, EN 60947-5-1, VDE 0660

Type		CEB-BCFE	CEB-BCF	CEB-BCS
Rated insulation voltage U_i ¹⁾	V AC	690	690	690
Thermal rated current I_{th} to bis 690V	max. 40°C A	10	25	10
	max. 60°C A	6	20	6
Frequency of operations z	1/h	3000	-	3000
Mechanical life	S x 10 ⁶	10	10	10
Power loss per pole at I_e /AC1	W	0,5	1,5	0,5
Utilization category AC15				
Rated operational current I_e	220-240V A	3	6	3
	380-400V A	2	3	2
	440V A	1,6	2	1,6
	500V A	1,2	2	1,2
	660-690V A	0,6	1	0,6
Utilization category DC13				
Rated operational current I_e	24V A	2	8	2
	48V A	2	8	2
	60V A	2	8	2
	110V A	0,4	1	0,4
	220V A	0,1	0,1	0,1
Short circuit protection short-circuit current 1kA, contact welding not accepted max. fuse size gL (gG) A				
		20	25	20
For contactors with thermal overload relay or auxiliary contacts the device with the smaller admissible control fuse (contactor or thermal overload relay) determines the fuse size.				
Cable cross-sections				
solid or stranded	mm ²	0,75-2,5	0,75-2,5	0,75-2,5
	flexible	mm ²	0,75-2,5	0,75-2,5
	flexible with multicore cable end	mm ²	0,5-1,5	0,5-1,5
solid	AWG	14 - 12	14 - 12	14 - 12
	flexible	AWG	18 - 12	18 - 12
Cables per clamp		2	2	2

1) Suitable for: earthed-neutral systems, overvoltage category I to IV, pollution degree 3 (standard-industry): $U_{imp} = 8kV$. Data for other conditions on request.

2) Command duration min. 30ms, 10% duty cycle, max. 30 sec.

Dimensions Accessories

Aux. cont. blocks, terminal blocks

CEB-BCFE 10

CEB-BCFE 01

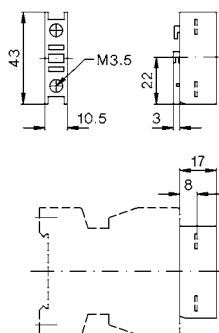

Auxiliary contact blocks

CEB-BCF 10

CEB-BCF 01

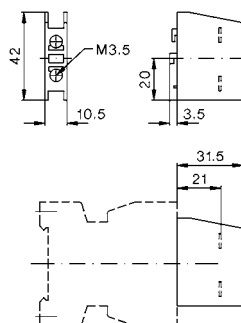
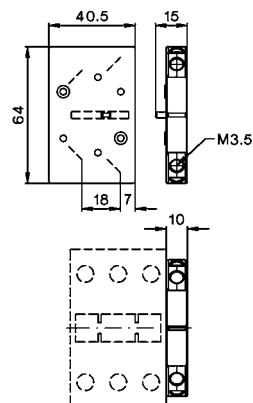
CEB-BCS1 11 CEB-BCS2 11
CEB-BCS2 02

CEB10.00
CEB14.00
CEB18.00
CEB22.00

CEB24.00
CEB32.00
CEB40.00

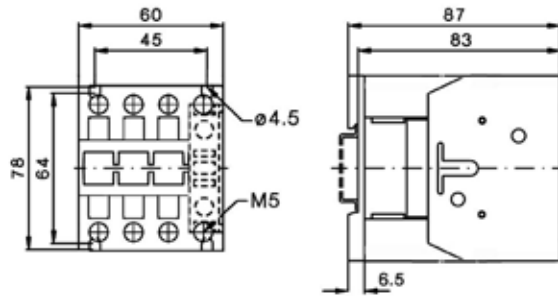
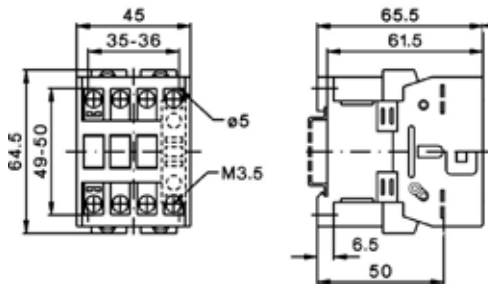

CEB50.00
CEB62.00
CEB74.00

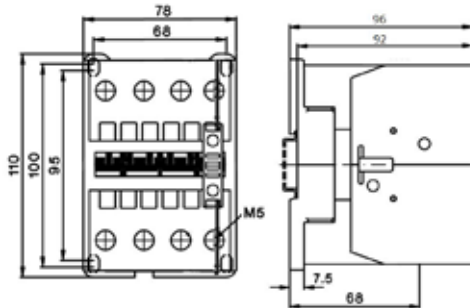

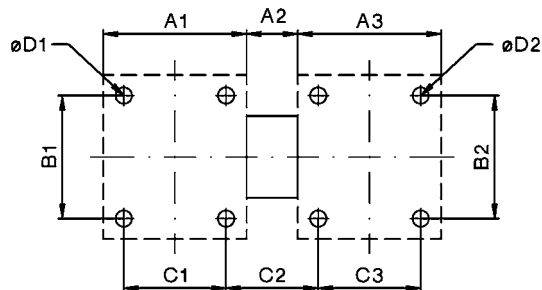

Mechanical interlocks



Type	Contactor 1	Contactor 2	A1	A2	A3	B1	B2	C1	C2	C3	D1	D2
CEB-MIL 10-40	CEB10.00 to CEB40.00	CEB10.00 to CEB40.00	45	7	45	50	50	35	17	35	4,5	4,5
	CEB10.00 to CEB22.00	CEB10.00 to CEB22.00	45	7	45	80	50	35	17	35	4,5	4,5
	CEB24.00 to CEB40.00	CEB22.00 to CEB40.00	45	7	45	80	50	35	17	35	4,5	4,5
CEB-MIL 50-74	CEB50.00 to CEB74.00	CEB24.00 to CEB40.00	60	12	55	100	65	50	22	45	5,5	4,5
	CEB50.00 to CEB74.00	CEB50.00 to CEB74.00	60	12	60	100	100	50	22	50	5,5	5,5

Individual coil for control voltage contactor



Individual coil for control voltage contactor

Type	Code No.	AC; DC coil	For use with	 g	
BCAE4-25-24 V-50/60 Hz*	004641810	AC			
BCAE4-25-48 V-50/60 Hz*	004641811	AC			
BCAE4-25-110 V-50/60 Hz*	004641812	AC		65	
BCAE4-25-230 V-50/60 Hz*	004641813	AC	CEM9		
BCAE4-25-400 V-50/60 Hz*	004641814	AC	-		
BCCE-25-24 V DC*	004642810	DC	CEM 25		
BCCE-25-48 V DC*	004642811	DC		120	
BCCE-25-110 V DC*	004642812	DC			
BCCE-25-220 V DC*	004642813	DC			
BCAE-40-24 V-50/60 Hz*	004641820	AC			
BCAE-40-48 V-50/60 Hz*	004641821	AC			
BCAE-40-110 V-50/60 Hz*	004641822	AC		110	
BCAE-40-230 V-50/60 Hz*	004641823	AC	CEM32		
BCAE-40-400 V-50/60 Hz*	004641824	AC	-		
BCCE-40-24 V DC*	004642820	DC	CEM40		
BCCE-40-48 V DC*	004642821	DC		180	
BCCE-40-110 V DC*	004642822	DC			
BCCE-40-220 V DC*	004642823	DC			
BCAE-105-24 V-50/60 Hz	004641830	AC			
BCAE-105-48 V-50/60 Hz	004641831	AC			
BCAE-105-110 V-50/60 Hz	004641832	AC		140	1
BCAE-105-230 V-50/60 Hz	004641833	AC	CEM50		
BCAE-105-400 V-50/60 Hz	004641834	AC	-		
BCCE-105-24 V DC	004642830	DC	CEM105		
BCCE-105-48 V DC	004642831	DC		220	
BCCE-105-110 V DC	004642832	DC			
BCCE-105-220 V DC	004642833	DC			
BCAE-112-24 V-50/60 Hz	004641840	AC			
BCAE-112-48 V-50/60 Hz	004641841	AC			
BCAE-112-110 V-50/60 Hz	004641842	AC	CEM112	235	
BCAE-112-230 V-50/60 Hz	004641843	AC			
BCAE-112-400 V-50/60 Hz	004641844	AC			
BCAE-180-24 V-50/60 Hz	004641850	AC			
BCAE-180-48 V-50/60 Hz	004641851	AC			
BCAE-180-110 V-50/60 Hz	004641852	AC	CEM180	400	
BCAE-180-230 V-50/60 Hz	004641853	AC			
BCAE-180-400 V-50/60 Hz	004641854	AC			
BCAE-250-24 V-50/60 Hz	004641860	AC			
BCAE-250-48 V-50/60 Hz	004641861	AC			
BCAE-250-110 V-50/60 Hz	004641862	AC	CEM250	675	
BCAE-250-230 V-50/60 Hz	004641863	AC			
BCAE-250-400 V-50/60 Hz	004641864	AC			

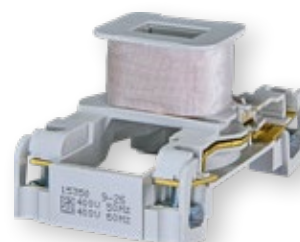
* Only AC coils can be fitted to AC controlled contactors
& only DC coils can be fitted to DC controlled contactors.





Individual coil for control voltage contactor

Type	Code No.	AC/CD coil	For use with		
BCEE-150E-28 V	004646044		CEM112E - CEM150E	235	
BCEE-150E-130 V	004646045				
BCEE-150E-250 V	004646046				
BCEE-150E-415 V	004646047				
BCEE-180E-28 V	004646048				
BCEE-180E-130 V	004646049	AC/DC	CEM180E	400	1
BCEE-180E-250 V	004646050				
BCEE-180E-415 V	004646051				
BCEE-300E-28 V	004646052				
BCEE-300E-130 V	004646053				
BCEE-300E-250 V	004646054		CEM250E - CEM300E	670	
BCEE-300E-415 V	004646055				
BCEE-560E 255V-AC/DC	004656322				
			CEM450E - CEM560E	1360	1/16



Electronic modules for BCEE coils

Type	Code No.	AC/CD coil	For use with		
MEE-300 28V-AC/DC	004646070	AC/DC	BCEE-150E-28 V, BCEE-180E-28 V, BCEE-300E-28 V	96	1
MEE-300 110V-AC/DC	004646072		BCEE-150E-130 V, BCEE-180E-130 V, BCEE-300E-130 V		
MEE-300 250V-AC/DC	004646073		BCEE-150E-250 V, BCEE-180E-250 V, BCEE-300E-250 V		
MEE-300 415V-AC/DC	004646074		BCEE-150E-415 V, BCEE-180E-415 V, BCEE-300E-415 V		
MEE-560 255V-AC/DC	004656321		BCEE-560E-255V		



ETICON **Motor protective circuit breakers**

Motor protective circuit breakers MSP

Description

The MSP0, MSP1 motor starter protectors are compact motor starter protectors for currents up to 52 A which operate according to the current limiting principle. The devices are used for switching and protecting motors or other loads. They are fitted with instantaneous overcurrent releases and inverse-time delayed overload relay. Motor starter protectors and contactors can be combined to form fuseless starter combinations. The MSP0, MSP1 motor starter protectors are suitable for use in any climate.

Motor Starter Protectors

- for motor protection

- MSP0: 0,4...25 A

- MSP1: 22...52 A



The characteristic curves of these motor starter protectors are specially laid-out for the overload and short-circuit protection of motors. The inverse-time delayed releases

("a releases") are adjustable for setting the rated current of the motors to be protected. The instantaneous short-circuit releases ("n releases") are fixed-set to 12 times the value so as to assure faultless starting of the motors.

Technical data according to IEC 60947-1; IEC 60947-2; IEC 60947-4-1

Type		MSP0	MSP1						
General data									
Number of poles		3	3						
Max. rated current I_n									
• motor protection	A	25	52						
Permissible ambient temperature									
• at full rated current	°C	-20 ... +55							
• in storage	°C	-50 ... +80							
Rated operational voltage U_e	V	690							
Rated frequency	Hz	50/60							
Rated insulation voltage U_i	V	750							
Rated impulse withstand voltage U_{imp}	kV	6							
Utilization category									
• to IEC 60947-2 (motor starter protectors)		A							
• to IEC 60947-4-1 (motor starters)		AC-3							
Mechanical endurance									
• up to 25 A	Operating cycles	100000	100000						
• 25 A upwards		--	30000						
Number of operating cycles/h (on load)	1/h	25	25						
Degree of protection with open terminals/with conductors connected									
Temperatures compensation to IEC 60947-4-1									
Phase failure sensitivity to IEC 60947-4-1									
Power loss P_v per breaker									
I_n	A	0,6	4	6	25	2,4	6	25	63
P_v	W	5	6	7	9	8	7	14	23

Motor protective circuit breaker MSP

Type	Code No.	Rated current [A]	Thermal overload release [A]	Instantaneous overcurrent release [A]	Motor power [kW]		
MSP0-0,6	004646618	0,6	0,4...0,6	7,2	0,12/0,18	290	1
MSP0-1,0	004646619	1	0,6...1,0	12	0,25	290	1
MSP0-1,6	004646620	1,6	1,0...1,6	19	0,37/0,55	290	1
MSP0-2,4	004646621	2,4	1,6...2,4	29	0,75	290	1
MSP0-4,0	004646622	4	2,4...4,0	48	1,1/1,5	290	1
MSP0-6,0	004646623	6	4,0...6,0	72	2,2	290	1
MSP0-10	004646624	10	6,0...10	120	3/4	290	1
MSP0-16	004646625	16	10...16	190	7,5	290	1
MSP0-20	004646626	20	14...20	240	7,5	290	1
MSP0-25	004646627	25	18...25	300	11	290	1
MSP1-32	004646628	32	22...32	380	15	760	1
MSP1-40	004646629	40	28...40	480	18,5	760	1
MSP1-52	004646630	52	36...52	600	22	760	1

Auxiliary contacts

Utilization category		AC-15		
Rated operational voltage U_e	ACV	230	400	500
Rated operational current I_e	A	3	1.5	1
Utilization category		DC-13		
Rated operational voltage U_e DC L/R200 ms	DCV	24	60	220
Rated operational current I_e	A	2.3	0.7	0.3

Type		MSP0	MSP1
Cross-section for main conductors			
Solid or stranded	mm ²	2 x (1...6)	1 x 1.5... 2 x 16 or 1 x 25 + 1 x 10
Finely stranded with end sleeve	mm ²	2 x (1... 4)	1 x 1.5... 2 x 10 or 1 x 16 + 1 x 10
Cross-sections for auxiliary and control connecting leads			
Solid or stranded	mm ²	1 x 0.5... 2 x 2.5	--
Finely stranded with end sleeve	mm ²	1 x 0.5... 2 x 1.5	--

Rated short-circuit breaking capacity

The table shows the rated ultimate short-circuit breaking capacity

I_{cu} and the rated service short-circuit breaking capacity I_{cs} for the MSP motor starter protectors with respect to rated current I_n and rated operational voltage U_e .

Infeed is permitted at top or bottom without reduction of rated data. In the short-circuit proof areas, I_{cu} is at least 100 kA. A backup fuse is therefore not necessary.

In the other areas, when the short-circuit current at the installation point exceeds the rated short-circuit breaking capacity given in the table for the motor starter protectors, the motor starter protector must be protected by a backup fuse. See the following table for the maximum rated current for the backup fuse. With a backup fuse according to the table, the maximum short-circuit current is permitted to equal the rated breaking capacity of the backup fuse.

Motor Starter Protectors	Rated current I_n	Up to AC 240 V			Up to AC 415 V			Up to AC 440 V			Up to AC 500 V			Up to AC 690 V		
		I_{cu}	I_{cs}	Max. Backup fuse (gL/gG)	I_{cu}	I_{cs}	Max. Backup fuse (gL/gG)	I_{cu}	I_{cs}	Max. Backup fuse (gL/gG)	I_{cu}	I_{cs}	Max. Backup fuse (gL/gG)	I_{cu}	I_{cs}	Max. Backup fuse (gL/gG)
Type	A	kA	kA	A	kA	kA	A	kA	kA	A	kA	kA	A	kA	kA	A
MSP0	≤ 1 A	Short-circuit proof up to 100 kA, backup fuse is not necessary														
	1.6 A	fuse is not necessary														
	2.4 A															
	3.2 & 4 A															
	5 & 6 A															
	8 & 10 A															
	13 & 16 A															
	20 & 25 A	10 (50)	10 (50)	100	6 (50)	6 (50)	80	5 (30)	5 (30)	80	3 (5)	3 (5)	80	2	2	80
MSP1	≤ 2.4 A	Short-circuit proof up to 100 kA, backup fuse is not necessary														
	4 A	fuse is not necessary														
	6 A															
	10 A															
	16 A															
	25 A															
	32 & 52 A															
					35	17	200	25	13	200	10	5	200	4	4	160

Curves

Characteristic curves

The characteristic curves are obtained in the cold state and 3-pole loading.

At operating temperature, the tripping time of the thermal releases drops by about 25 %. With 3-pole loading, the deviation in tripping time for 3 times the current and upwards is ±20 %.

Characteristic curves for MSP0

The characteristic curves shown here apply for a MSP0-6 motor starter protector with a rated current of 6 A, a current setting range of 4 to 6 A and a tripping current for the instantaneous overcurrent release of 72 A, at a rated voltage of AC 50 Hz, 400 V.

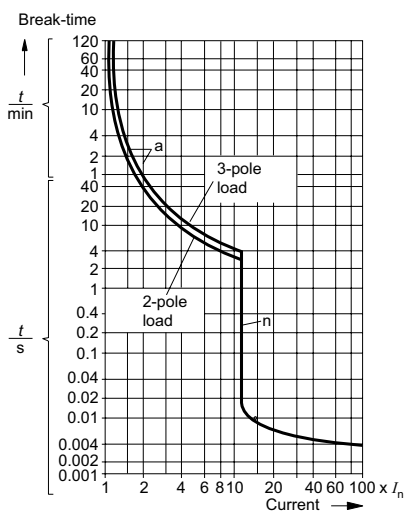

Schematic representation of the time/current characteristic for MSP0

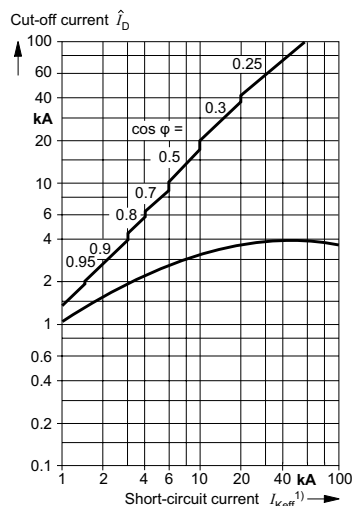

Current limiting characteristic for MSP0-6

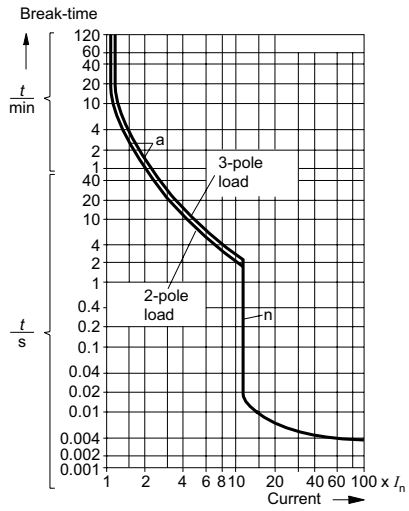

Schematic representation of the time/current characteristic for MSP1

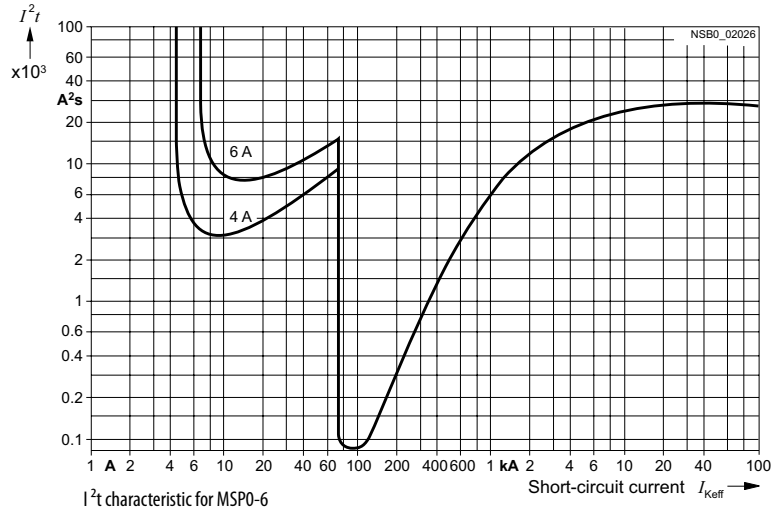

I²t characteristic for MSP0-6

Characteristic curves for MSP1

The characteristic curves shown here apply for a motor starter protector with a rated current of 25 A and a tripping current for the instantaneous overcurrent release of 300 A, at a rated voltage of AC 50 Hz, 400 V.

Relation between short-circuit breaking capacity I, related power factor and minimum short-circuit making capacity to IEC 60947-2.

Short-circuit breaking capacity		Power factor cos φ	Short-circuit making capacity
		A	
	I ≤ 3000	0.9	1.42 x I
3000 <	I ≤ 4500	0.8	1.47 x I
4500 <	I ≤ 6000	0.7	1.5 x I
6000 <	I ≤ 10000	0.5	1.7 x I
10000 <	I ≤ 20000	0.3	2.0 x I
20000 <	I ≤ 50000	0.25	2.1 x I
50000 <	I	0.2	2.2 x I

Dimensions

MSP0

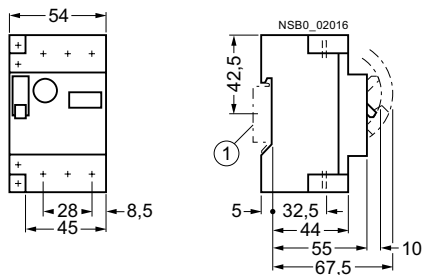

① TH 35 standard mounting rail acc. to IEC 60715

MSP1

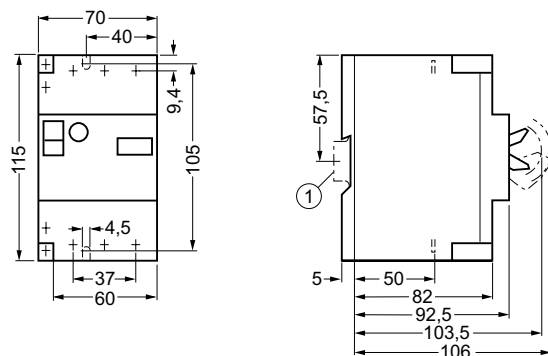

① TH 35 standard mounting rail acc. to IEC 60715

ETICON / Motor protective circuit breakers

Space required above arc chutes

Minimum clearance with rated voltage to adjacent parts as well as non-insulated live parts.

The spacing of minimum 1 cm with MSP0 and minimum 2 cm with MSP1 between large-surface covers and arc openings should be observed.

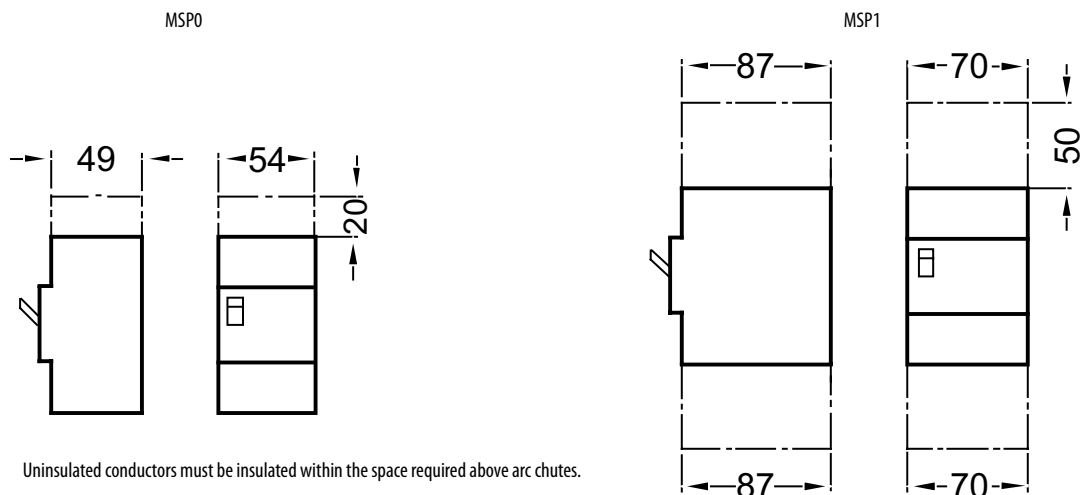

Uninsulated conductors must be insulated within the space required above arc chutes.

Permissible mounting position

MSP0, MSP1 motor starter protectors permissible mounting position due to the position of the operating parts

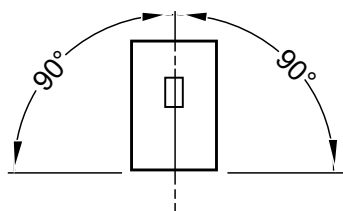

Front view

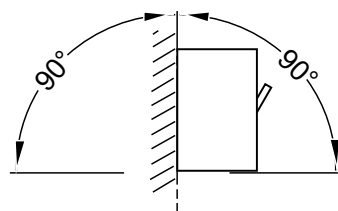

Lateral view

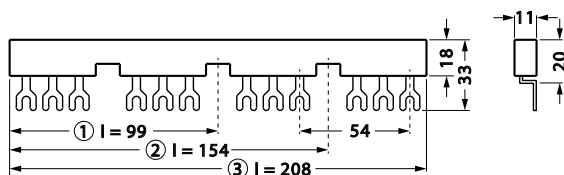

three-phase busbar

- ① For 2 devices: MSP-I22
- ② For 3 devices: MSP-I23
- ③ For 4 devices: MSP-I24

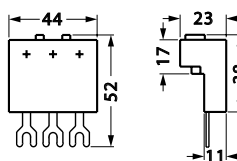

MSP-TA2
three-phase feed-in terminal,
type I

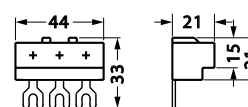



MSP-TA1
three-phase feed-in terminal,
type II

Accessories



Combinations:
 Right hand side of MSP: An auxiliary contact and/or a short-circuit signalling contact
 Left hand side of MSP: Undervoltage release or Shunt release

Short circuit trip indication

Type	Code No.	Description	Wiring diagram		
MSP-AS	004646617	1NO+1NC (AC-15: 3A/230V, 1.5A/400V, 1A/500V)		40	1



width=9mm

Auxiliary contact

Type	Code No.	Description	Wiring diagram		
MSP-PS11	004646631	1NO+1NC (AC-15: 3A/230V, 1.5A/400V, 1A/500V)		40	1



width=9mm

Shunt release

Type	Code No.	Rated voltage Un	Operation range		
MSP-A 230	004646632	230 VAC (220-230V 50Hz)	154-253 VAC	110	1
MSP-A 24	004646633	24 VAC (24V 50Hz, 24-60V DC)	16.8 - 26.4 VAC, 16.8 - 66VDC	110	1



width=18mm, operation range: 0.7-1.1*Un

Undervoltage release

Type	Code No.	Rated voltage Un	Operation range (for keeping)		
MSP-U 240	004646634	240 V 50Hz	204-264 VAC	110	1

width=18mm, Falling(tripping) voltage: 0.35-0.7 Un, keeping voltage: 0.85-1.1Un.

Connection terminals

Type	Code No.	Description		
MSP-IZ2	004646635	busbar connection of 2 MSPs	50	1
MSP-IZ3	004646636	busbar connection of 3 MSPs	50	1
MSP-IZ4	004646637	busbar connection of 4 MSPs	100	1
MSP-TA1	004646638	3 phase line side terminal	110	1
MSP-TA2	004646639	3 phase line side terminal (in combination with MSP-IZ...)	50	1

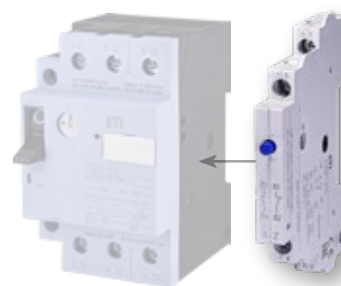

MSP-AS

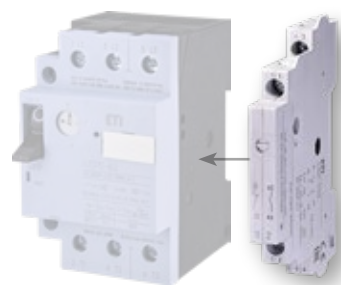

MSP-PS11

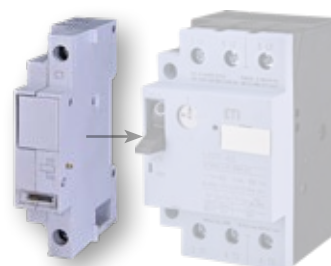

MSP-A 230



MSP-U 240



MSP-IZ3



MSP-TA1



MSP-TA2

Motor protective circuit breakers MPE

General technical data

			MPE25	MPE80
Operational inst. current I_u		A	0,16 ... 40	50 ... 80
Rated short-circuit capacity		kA	50	60
Standards	IEC/EN 60 947			
Climatic proffing	damp heat, constant to IEC 60 068-2-3 damp heat, cyclical to IEC 60 068-2-30			
Ambient temperature	Storage	°C	-50 ... +80	
	Open	°C	-20 ... +70	
	Enclosed	°C	-20 ... +35	
Mounting position	any position			
Degree of protection	IP20			
Protection against direct contact	IP20			
Shock resistance to IEC 60 068-2-27		g	15	
Altitude		m	2000	
Conductor cross-section for main circuit	solid & stranded	mm ²	1 x (1,5 ... 6) / 2 x (1,5 ... 6)	1 x (1,5 ... 35) / 2 x (2,5 ... 35)
Tightening torque	main circuits	Nm	2,0 ... 2,5	
	control circuits	Nm	1,0 ... 1,25	
Main contacts				
Rated impulse withstand voltage U_{imp}		kV	6	
Overvoltage categ./pollution degree	III/3			
Rated operational voltage U_e		V	690	
Rated operational current I_e		A	25 or setting current of overload release	
Rated frequency		Hz	50/60	
Current heat losses, 3-pole at oper. T		W	5 (MPE25-0,1 - MPE25-0,63)	
		W	6 (MPE25-1 - MPE25-6,3)	
		W	7 (MPE25-10)	
		W	8 (MPE25-16 - MPE25-25)	
		W	10 (MPE25-32)	
Life span, mechanical / electrical		Ops.	100.000 / 100.000	50.000 / 25.000
Maximum operating frequency		Ops./h	15	
Releases				
Temperature compensation		°C	-20 ... +60	
Adjustable overload releases		x I_u	0,6 - 1	
Fixed short circuit releases		x I_u	13	
Phase failure sensitivity	IEC/EN 60 947-4-1			
Auxiliary contacts				
Rated impulse withstand voltage		kV	6	
Overvoltage category/pollution degree	III/3			
Rated operational voltage		V	690 (250 -> ACBFE...)	
Rated operational current				
AC-15	24V	I_e	A	6 (2 -> ACBFE)
	230V	I_e	A	4 (0,5 -> ACBFE)
	380V-415V	I_e	A	3 (0 -> ACBFE)
	440V-500V	I_e	A	2 (0 -> ACBFE)
DC-13	24V	I_e	A	2 (1 -> ACBFE)
	60V	I_e	A	0.5 (0,15 -> ACBFE)
	110V	I_e	A	0.5 (0 -> ACBFE)
	220V	I_e	A	0.25 (0 -> ACBFE)
Control circuit reliability at U_e	Fault probability		Umin = 17V, Imin = 5mA < 1 fault in 1 milion operations	
	Short-circuit rating without welding	Fuse gG	A	10
Conductors cross-section for auxiliary and control circuits	solid or stranded	mm ²	1 x (0,5 ... 2,5) / 2 x (0,5 ... 2,5)	



Advantages

- // With overload and short circuit protection
- // Fixed short circuit release $13 \times I_n$
- // With phase-failure sensitivity according to IEC/EN 60947-4-1
- // With temperature compensation
- // Can be used as main switch
- // MPE25 up to 10A at 400/415V are self-protected
- // MPE25 above 10A provide a breaking capacity of 50kA at 400/415V according to IEC/EN 60947-2

- // MPE80 provide a breaking capacity of 60kA at 380V according to IEC/EN 60947-2

IE3 CONFORM

Motor protective circuit breaker MPE

Type	Code No.	Operational inst. current I_n (A)	Setting overl. release I_l (A)	Short-circuit release I_m (A)		
MPE25-0,16	004648001	0,16	0,1-0,16	2,08	322	1
MPE25-0,25	004648002	0,25	0,16-0,25	3,25	322	1
MPE25-0,40	004648003	0,4	0,25-0,4	5,2	322	1
MPE25-0,63	004648004	0,63	0,4-0,63	8,2	322	1
MPE25-1,0	004648005	1	0,63-1,0	13	322	1
MPE25-1,6	004648006	1,6	1,0-1,6	20,8	322	1
MPE25-2,5	004648007	2,5	1,6-2,5	32,5	322	1
MPE25-4,0	004648008	4	2,5-4,0	52	322	1
MPE25-6,3	004648009	6,3	4,0-6,3	82	322	1
MPE25-10	004648010	10	6,3-10	130	322	1
MPE25-16	004648011	16	10-16	208	322	1
MPE25-20	004648012	20	16-20	260	322	1
MPE25-25	004648013	25	20-25	325	322	1
MPE25-32	004648014	32	25-32	416	322	1
MPE25-40	004648015	40	32-40	520	322	1
MPE80-50	004648016	50	40-50	650	1070	1
MPE80-65	004648017	65	50-65	845	1070	1
MPE80-80	004648018	80	65-80	1040	1070	1



Example of MPE configuration:

MPE25-0,16 ... 40 - Overload and Short-Circuit Protection

Reference values for selecting protection of three-phase electric motors 60 Hz - 4 poles			Rated current In [A]	Overload release setting In [A]	Instantaneous magnetic trip 13x In Im [A]
220-240 V cv / kW	380-415 V cv / kW	440-480 V cv / kW			
-	-	-	0.16	0.1...0.16	2.08
-	-	-	0.25	0.16...0.25	3.25
-	-	0.16 / 0.12	0.4	0.25...0.4	5.2
-	0.16 / 0.12	0.25 / 0.18	0.63	0.4...0.63	8.2
0.16 / 0.12	0.33 / 0.25	0.33 / 0.25	1	0.63...1	13
0.33 / 0.25	0.5 / 0.37	1 / 0.75	1.6	1...1.6	20.8
0.5 / 0.37	1 / 0.75	1.5 / 1.1	2.5	1.6...2.5	32.5
1 / 0.75	2 / 1.5	2 / 1.5	4	2.5...4	52
1.5 / 1.1	3 / 2.2	4 / 3	6.3	4...6.3	82
3 / 2.2	6 / 4.5	7.5 / 5.5	10	6.3...10	130
5 / 3.7	10 / 7.5	12.5 / 9.2	16	10...16	208
7.5 / 5.5	12.5 / 9.2	15 / 11	20	16...20	260
-	15 / 11	-	25	20...25	325
12.5 / 9.2	20 / 15	20 / 15	32	25...32	416
15 / 11	25 / 18.5	25 / 18.5	40	32...40	520

MPE80-50...80 - Overload and Short-Circuit Protection

Reference values for selecting protection of three-phase electric motors 60 Hz - 4 poles			Rated current In [A]	Overload release setting In [A]	Instantaneous magnetic trip 13x In Im [A]
220-240 V cv / kW	380-415 V cv / kW	440-480 V cv / kW			
15 / 11	25 / 18.5	30 / 22	40	32...40	520
-	30 / 22	40 / 30	50	40...50	650
25 / 18.5	40 / 30	50 / 37	65	50...65	845
30 / 22	50 / 37	60 / 45	80	65...80	1,040

Technical data

Tripping devices

Rated operational voltage	Ue	V	200-415V
Conductor cross-section for main circuit	solid or stranded	mm ²	1 x (0,5 to 2,5) / 2 x (0,5 to 2,5)
Shunt Releases			
Operating range		x Us	0,7 - 1,1
Power consumption	Pull	VA	10
	Sealing	VA	4.5
Undervoltage Releases			
Pick-up voltage		x Us	0,85 - 1,1
Drop-out voltage		x Us	0,7 - 0,35

MPE25 wired 1- or 2-pole

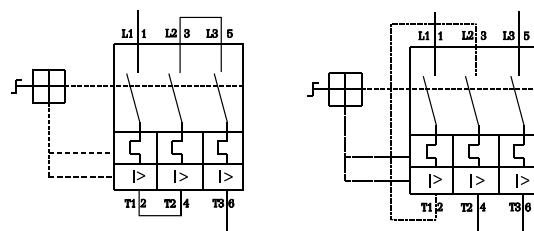

Typical circuits

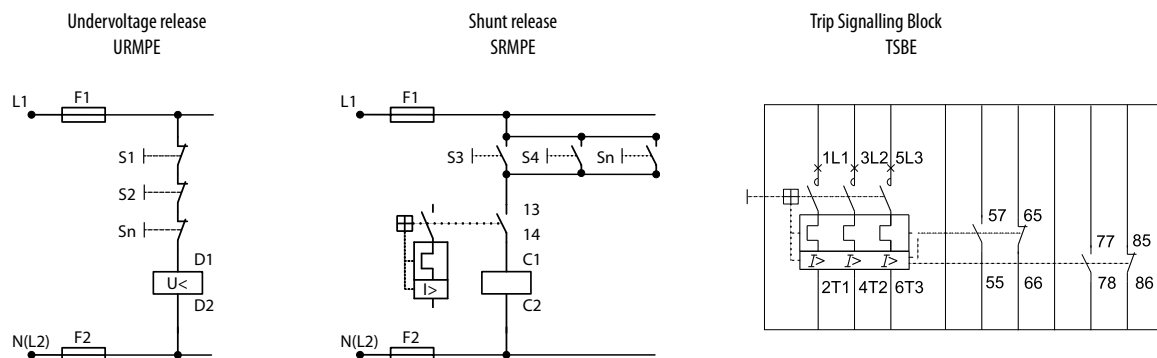

Altitude - Factor of Correction

Altitude (above the sea level) - h	Rated operational voltage Ue	Factor of correction Iu
h < 2000m	690V	1 x In
2000m < h < 3000m	550V	0,96 x In
3000m < h < 4000m	480V	0,93 x In
4000m < h < 5000m	420V	0,90 x In

Breaking capacity of motor protective circuit breakers MPE25

Model	220-230 V ac				380-415 V ac			440 V ac			460-500 V ac			630-690 V ac		
	Max. Current	I _{cu}	I _{cs}	Max. fuse (gL/gG)	I _{cu}	I _{cs}	Max. fuse (gL/gG)1	I _{cu}	I _{cs}	Max. fuse (gL/gG)1	I _{cu}	I _{cs}	Max. fuse (gL/gG)1	I _{cu}	I _{cs}	Max. fuse (gL/gG)1
	kA	kA	A	kA	kA	A	kA	kA	A	kA	kA	kA	A	kA	kA	A
MPE25	0.16	100	100	-	100	100	-	100	100	-	100	100	-	100	100	-
	0.25	100	100	-	100	100	-	100	100	-	100	100	-	100	100	-
	0.4	100	100	-	100	100	-	100	100	-	100	100	-	100	100	-
	0.63	100	100	-	100	100	-	100	100	-	100	100	-	100	100	-
	1	100	100	-	100	100	-	100	100	-	100	100	-	100	100	-
	1.6	100	100	-	100	100	-	100	100	-	100	100	-	100	100	-
	2.5	100	100	-	100	100	-	100	100	-	100	100	-	8	8	25
	4	100	100	-	100	100	-	100	100	-	100	100	-	8	8	35
	6.3	100	100	-	100	100	-	100	100	-	100	100	-	8	8	50
	10	100	100	-	100	100	-	50	25	80	42	21	63	8	8	50
	16	100	100	-	50	25	100	50	15	80	10	8	80	5	5	63
	20	100	100	-	50	25	125	50	15	80	10	8	80	5	5	63
	25	100	100	-	50	25	125	50	15	100	10	8	80	5	5	80
	32	100	100	-	50	25	125	25	15	100	10	8	100	5	5	100
40	100	100	-	30	15	125	20	10	125	10	5	125	5	2	125	
MPE80	40	100	100	-	65	65	160	65	65	125	35	35	125	8	8	125
	50	100	100	-	65	65	160	65	65	160	35	35	160	8	8	160
	65	100	100	-	65	65	200	65	65	200	35	35	200	8	8	200
	80	65	65	224	65 ²⁾ / 10 ³⁾	25 ²⁾ / 10 ³⁾	224	10	10	224	10	10	224	6	6	224

I_{cc} = Prospective short-circuit current

I_{cu} = Rated ultimate short-circuit breaking capacity

I_{cs} = Rated service short-circuit breaking capacity

Notes: 1) Fuse required if the prospective short-circuit current exceeds the rated ultimate short circuit breaking capacity (I_{cc} > I_{cu})

2) U_e ≤ 380 V.

3) U_e = 400/415 V.

Curves

The tripping characteristic shows the motor circuit breaker trip time in relation to the rated current. The curves show average tolerance range values for an ambient temperature of 20 °C, starting in cold state.

Thermal trip time when working in operating temperature is reduced to around 25% of the presented values. Under normal operating conditions, all 3 circuit breaker phases must be conducting.

MPE25...80

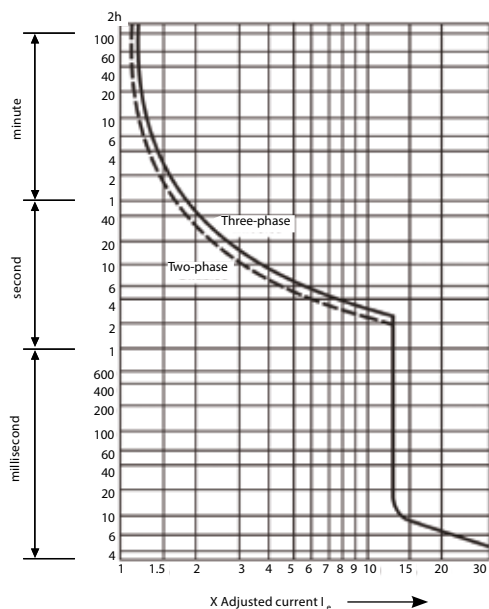

MPE25, MPE80 I-t diagram

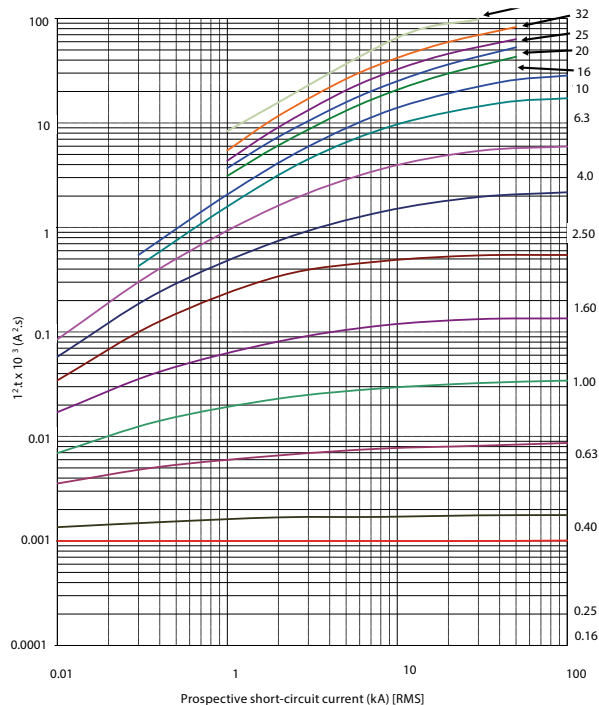

MPE25 Let-through characteristics at 415V

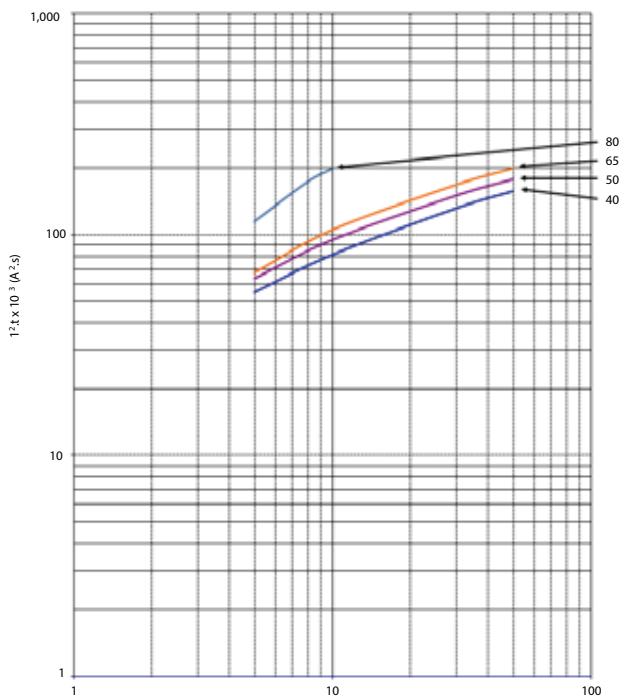

MPE80 Let-through characteristics at 415V

The MPE 25 switching of direct current

The MPE circuit breakers for alternating current are able to switch direct current. However, you are obliged to observe the maximum permissible DC voltage per conducting path. In case of higher voltages, series connection of 2 or 3 conducting parts is required. The response characteristics of the overload releases remain unchanged. The response thresholds of the short-circuit releases are increased with direct current by approximately 35%.

The following table shows suggestions for switching direct current:

Recommended Connection	Highest Permissible Direct Voltage	Explanation
	150V DC	2-poles switching Ungrounded system If ground fault can be excluded, or if every ground is immediately corrected (via ground-fault monitoring), the maximum permissible DC voltage can be multiplied by 3
	300V DC	2-poles switching Grounded system The grounded pole should be assigned to the individual conducting path so that in the event of a ground fault there are always 2 conducting paths in series
	450V DC	1-pole switching Grounded system 3 conducting paths in series. The grounded pole should be assigned to the unswitched conducting path.

DC short-circuit breaking capacity (time constant <=5ms)

- 1 conducting path DC 150V 10kA
- 2 conducting paths in series DC 350V 10kA
- 3 conducting paths in series DC 350V 10kA

Dimensions

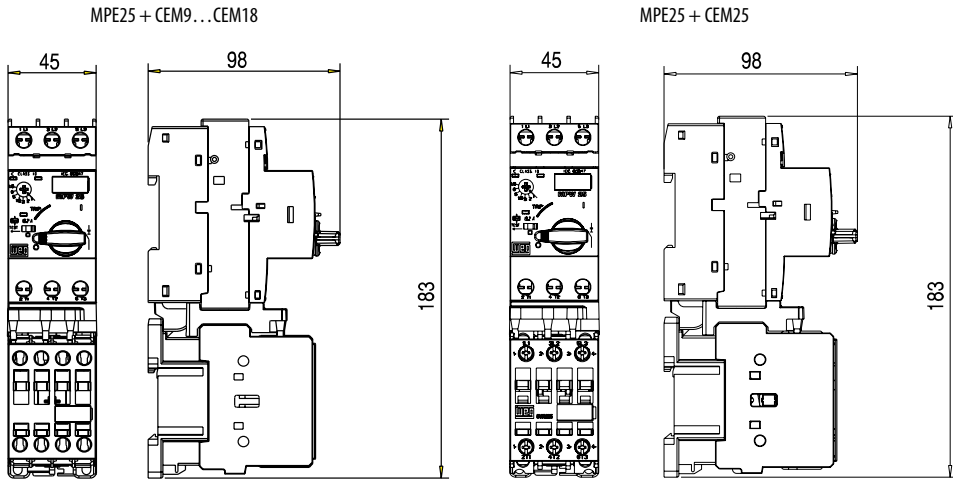

ETICON / Motor protective circuit breakers

MPE25+ CE07

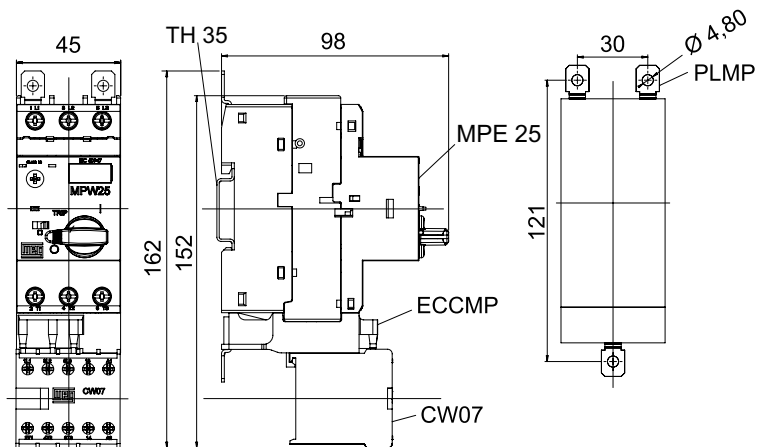

MPE25 + Accessories

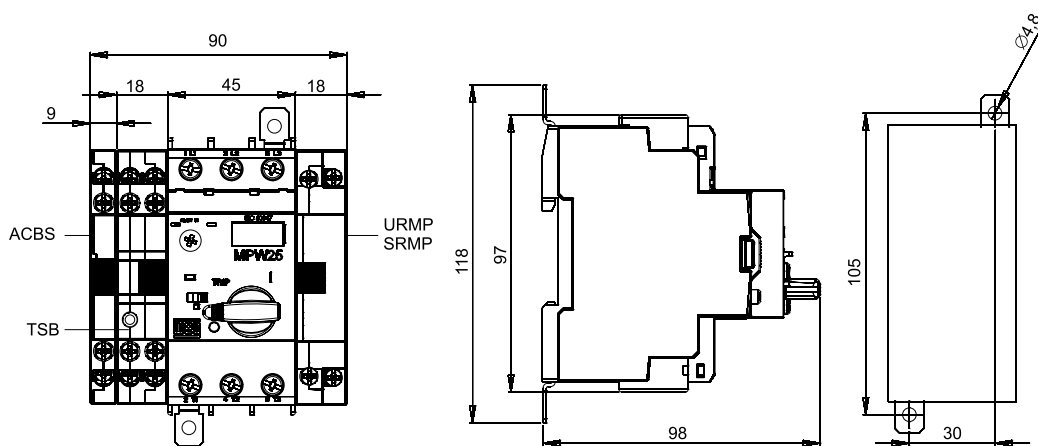

MPE80 + Accessories

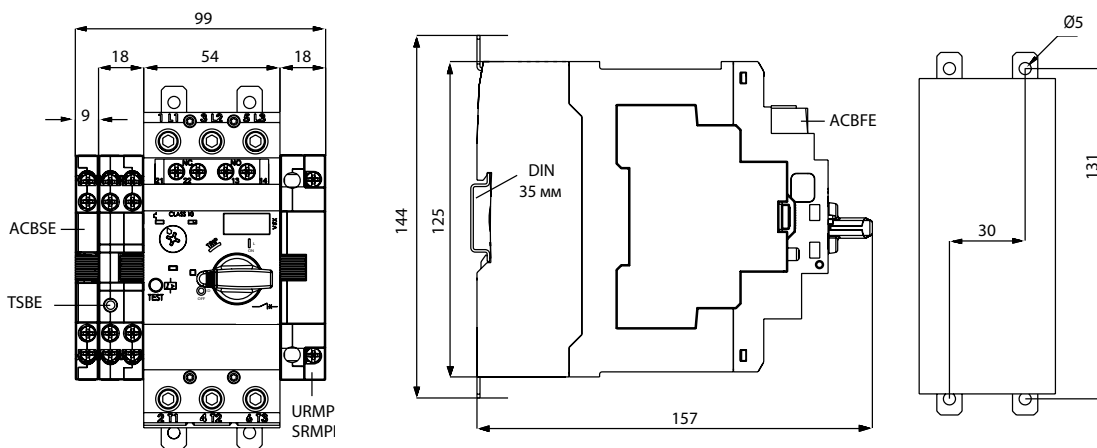

Frontal plate FMEE5SE

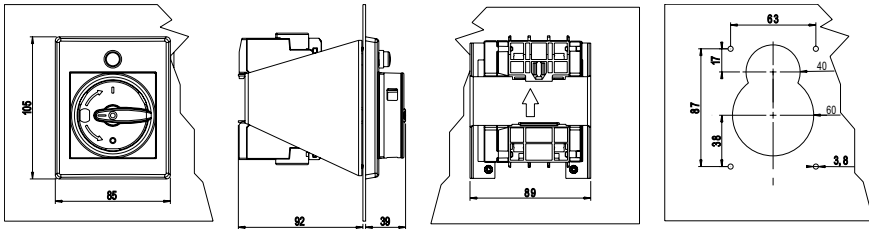

Mounting position

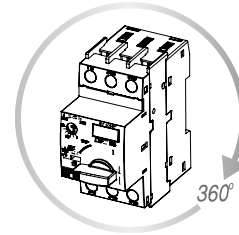

Insulated Enclosure - MPEE55

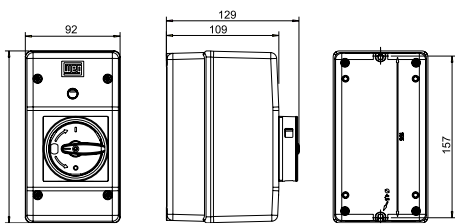

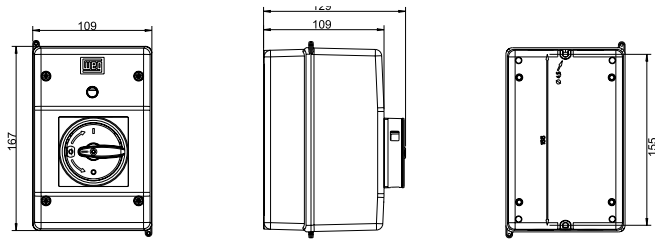

Insulated Enclosure - MLPEE55

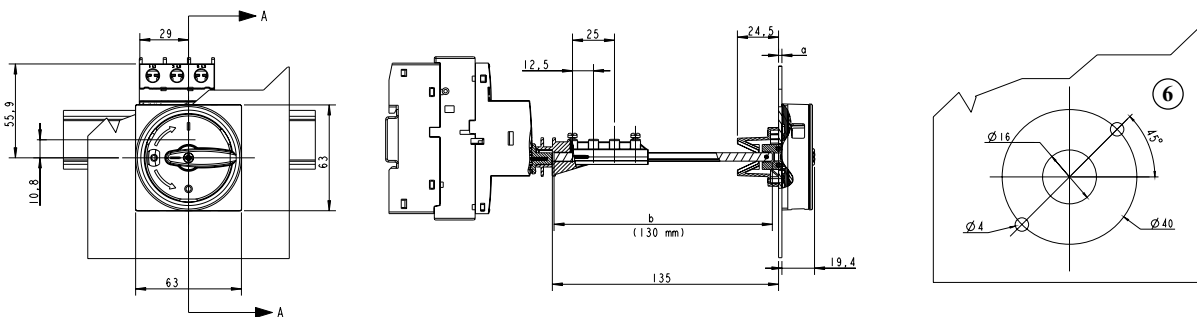

Door coupling rotary handle RMMPE



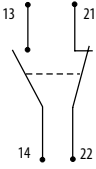

Front mountable auxiliary contact block, the 45mm widths - MPE remain unchanged

Type	Code No.	Wiring diagram	Auxiliary contacts NO, NC		
ACBFE-11	004648021		1, 1	20	1



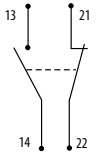
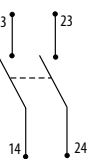

ETICON / Motor protective circuit breakers

Left side mountable contact block, can be combined with front mountable auxiliary contact block

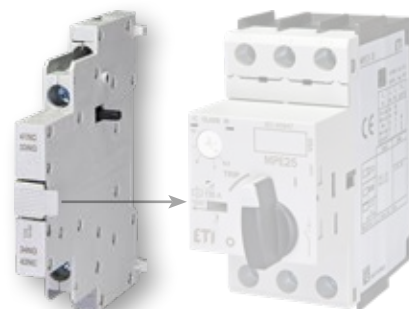
Type	Code No.	Wiring diagram	Auxiliary contacts NO, NC		
ACBSE-11	004648022		1, 1	38	1
ACBSE-20	004648023		2, 0	38	1



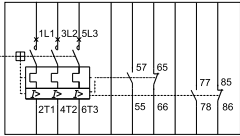

Trip indicating contact block, mounted on the left side

Type	Code No.	Wiring diagram	Notes		
TSBE	004648024		Separate tripped and short-circuit 1NC for each circuit. Allows mounting with lateral aux. contact block. Left side mounting. TBSE alarms, 1NO +	150	1



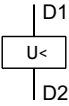

Undervoltage release, mounted on the right side

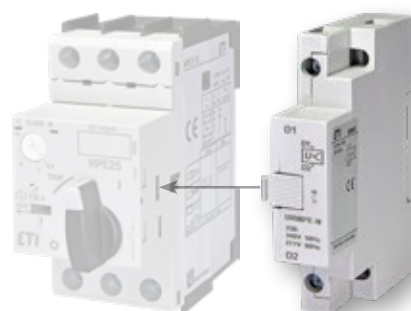
Type	Code No.	Wiring diagram	actuating voltages		
URMPE-N	004648027		230-240V AC	115	1
URMPE-U	004648028		400-415V AC		



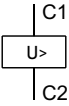

Shunt release, mounted on the right side

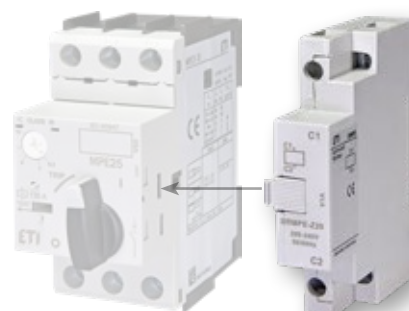
Type	Code No.	Wiring diagram	actuating voltages		
SRMPE-Z20	004648030		200-240V AC	115	1





Pick-up voltage 0,7 x Ue 100%DF

Accessories

Type	Code No.	Description		
SCMPE	004648025	Scale cover	15	5
PLMPE	004648026	Push-in-lugs	25	2





Insulated enclosure with black/grey rotary handle, IP55

For use with	Code No.	Notes	Type		
MPE25 + ACBFE11 + ACBSE11 // ACBSE20 + PL..	004648032	with black/grey rotary handle with integrated PE(N) terminal	MPEE55G	365	1
MPE25 + URMPE // SRMPE + ACBFE11 + ACBSE11 ali ACBSE20 + PL..	004648033	lockable in OFF position with 3 padlocks two M25 metric cable entry knockout, top and bottom	MLPEE55G	415	1





Insulated enclosure with red/yellow rotary handle, IP55



For use with	Code No.	Notes	Type		
MPE25 + ACBFE11 + ACBSE11 // ACBSE20 + PL..	004648034	with red/yellow rotary handle for use as Emergency-Stop switches to IEC/EN 60204 with integrated PE(N) terminal	MPEE55G-E	365	1
MPE25 + URMPE // SRMPE + ACBFE11 + ACBSE11 or ACBSE20 + PL..	004648035	lockable in OFF position with 3 padlocks two M25 metric cable entry knockout, top and bottom	MLPEE55G-E	415	1





Neutral terminal

For use with	Code No.	Description	Type		
MPEE55G, MLPEE55G, MPEE55G-E & MLPEE55G-E	004648038	for connection of a 5th conductor	NL-MPEE	365	1



Flush mounting enclosure

Type	Code No.	colour	Description		
FMEE55	004648036	black	- for MPE mounting on panel door - degree of protection IP55 - moulded plastic front plate with rotary operating mechanism - lockable in OFF position	200	1
FMEE55-E	004648037	red/yellow	- allows access. ACBFE-11, ACBSE-11 or ACBSE-20 and URMPE / SRMPE - allow installation of sig. lamp	200	1

**Door coupling rotary handle black/grey and red/yellow, IP55**



Type	Code No.	colour	Notes		
RMMPE130 (130 mm)	004648039	black	- extension shaft, length 130 to 155mm	76	1
RMMPE330 (330 mm)	004648040		- extension shaft, length 330 to 355mm - door coupling rotary handle black/grey - extension shaft can be cut at any required length min. 80mm	114	
RMMPE130E (130 mm)	004648041	red/yellow	- thickness of panel door 1 to 3,5mm - for use of main switch IEC/EN60204 - ON/OFF/Tripped position	76	1
RMMPE330E (330 mm)	004648042		- lockable in OFF pos. with 3 padlocks - the MPE can also be used turned 90°	114	

**Indicator light**

Type	Code No.	Notes	colour		
PLE230 PLE400	004648043 004648044	voltage: 210...230V voltage: 400...560V	red	17	10
PLE230G PLE400G	004648045 004648046	voltage: 210...230V voltage: 400...560V	green		
PLE230W PLE400W	004648047 004648048	voltage: 210...230V voltage: 400...560V	white		



Circuit breaker-contactor link module

Type	Code No.	Notes	For use with		
ECCMPE07	004648052	for electrical and mechanical linking	CE07		
		motor protective circuit breaker		27	1
ECCMPE25*	004648053	MPE25 and contactor	CEM9...25		

*For contactors with AC coil only!

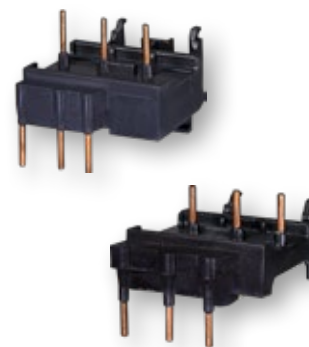

Motor protective circuit breaker MS25

Main application field: control (start-up, protection and switch-off) of AC electric motors with powers up to 11 kW (380/400 V) or other consumers up to 25 A; it can also be used as the main switch according to EN 60204 or VDE 0113 standards.

Versions:

- MS25 - with overload and short circuit protection

Manual control:



- START, STOP, push-buttons
- Test of release function (TEST)

- // Phase-failure sensitivity according to IEC/EN 60947-4-1
- // Automatic switch-off with thermal or magnetic release
- // Control with under-voltage release or shunt release
- // Isolating distance between contacts: 4.5 mm per contact place
- // Hard wire or fine wire connection
- // Simple and fast mounting by snap fitting on 35 mm wide mounting rail in compliance with EN 60715; fixing with two screws is also possible
- // Vertical or horizontal operation position

Technical data - General

Standards	IEC/EN 60947-2, IEC/EN 60947-4-1, IEC/EN 60947-5-1, IEC/EN 60204	
Climatic class	constant damp heat acc. to IEC 60068-2-78 cyclic damp heat acc. to IEC 60068-2-30	
Degree of protection	IP20, after terminals covering IP20	
Ambient temperature	°C	-25 ... +60
Storage temperature	°C	-25 ... +70
Temperature range of thermal compensation for overload release	°C	-5 ... +40
Mechanical and electrical endurance	100,000	
Shock resistance acc. to IEC 68-2-27	g	20
Vibration resistance acc. to IEC 68-2-6	5 g - f = 5 ... 150 Hz	
Overvoltage category / pollution degree	III / 3	
Rated insulation voltage U_i	V	690
Rated impulse withstand voltage U_{imp}	kV	6
Weight	kg	0.252

Motor protective circuit breaker MS25

Type	Code No.	Operational inst. current I_n (A)	Setting overl. release I_r (A)		
MS25-0,16	004600010	0.16	0,1-0,16	255	1
MS25-0,25	004600020	0.25	0,16-0,25	255	1
MS25-0,40	004600030	0.4	0,25-0,4	255	1
MS25-0,63	004600040	0.63	0,4-0,63	255	1
MS25-1,0	004600050	1	0,63-1,0	255	1
MS25-1,6	004600060	1.6	1,0-1,6	255	1
MS25-2,5	004600070	2.5	1,6-2,5	255	1
MS25-4,0	004600080	4	2,5-4,0	255	1
MS25-6,3	004600090	6.3	4,0-6,3	255	1
MS25-10	004600100	10	6,3-10	255	1
MS25-16	004600110	16	10-16	255	1
MS25-20	004600120	20	16-20	255	1
MS25-25	004600320	25	20-25	255	1



Technical data - Main circuit

Designation of connection terminals			1 - L1 ; 3 - L2 ; 5 - L3 ; 2 - T1 ; 4 - T2 ; 6 - T3
Terminal capacity	rigid	S (mm ²)	0.75 ... 6
	flexible		0.75 ... 4
Screw	with self-lifting clamp, protected against falling out		
Screw head	PZ2		
Tightening torque	1,8 Nm		
Max. operational voltage	Ue	V	690
Setting range			0.1 - 0.16 (MS25); 0.16 - 0.25 (MS25); 0.25 - 0.4; 0.4 - 0.63; 0.63 - 1; 1 - 1.6; 1.6 - 2.5; 2.5 - 4; 4 - 6.3; 6.3 - 10; 10 - 16; 16 - 20; 20 - 25
No. of poles	3		
Operating current of thermal overload release	I		1.05 I _r < I ≤ 1.20 I _r
			I _r ... set value
Sensitivity to phase failure	✓		
Operating current of magnetic overload release	I		11 I _n < I ≤ 13 I _n ± 20 %
			I _n ... upper setting limit
Power dissipation on pole at load with I _n	P	W	2 - 2.5
Utilization category	IEC/EN 60947-4-1		AC-3
	IEC/EN 60947-2		A
Trip class acc. to IEC/EN 60947-4-1	10A		

MST25 motor protection switches and max. back-up fuses for short-circuit protection:

Type	Max. back-up fuse U _e < 400 V gL (A)
MST 25 - 0,4	1
MST 25 - 0,63	2
MST 25 - 1	2
MST 25 - 1,6	4
MST 25 - 2,5	6
MST 25 - 4	16
MST 25 - 6,3	20
MST 25 - 10	25
MST 25 - 16	35
MST 25 - 20	50
MST 25 - 25	50

MS25 motor protection switches, rated ultimate short-circuit breaking capacity Icu and max. back-up fuses if prospective short-circuit current Icp exceeds Icu:

Type	Operating current of short-circuit release (A)	Rated ultimate short-circuit breaking capacity Icu (kA)				Max. back-up fuse, if Icp > Icu (gL) (A)			
		230 V	400 V	500 V	690 V	230 V	400 V	500 V	690 V
MS 25 - 0,16	2	50	50	50	50				
MS 25 - 0,25	3	50	50	50	50				
MS 25 - 0,4	5	50	50	50	50				
MS 25 - 0,63	8	50	50	50	50				
MS 25 - 1	12	50	50	50	50				
MS 25 - 1,6	20	50	50	50	50				
MS 25 - 2,5	33	50	50	3	2,5			25	20
MS 25 - 4	44	50	50	3	2,5			35	25
MS 25 - 6,3	75	50	50	3	2,5			50	35
MS 25 - 10	120	50	6	3	2,5		80	50	35
MS 25 - 16	160	6	4	2,5	2	80	80	63	35
MS 25 - 20	230	6	4	2,5	2	80	80	63	50
MS 25 - 25	270	6	4	2,5	2	80	80	63	50

Switch selection for motor protection

Single-phase	Standard motor power					Setting range
	220 V	230 V	380 V	440 V	500 V	
220 V	220 V	380 V				
230 V	230 V	400 V	440 V	500 V	660 V	
240 V	240 V	415 V			690 V	
		kW				A
		0,02			0,06	0,1 ... 0,16
		0,06	0,06	0,06	0,09	0,16 ... 0,25
	0,06	0,09	0,12	0,12	0,18	0,25 ... 0,4
	0,09	0,12	0,18	0,25	0,25	0,4 ... 0,63
0,06 ... 0,09	0,09 ... 0,12	0,18 ... 0,25	0,25	0,37	0,37 ... 0,55	0,61 ... 1
0,12	0,18 ... 0,25	0,37 ... 0,55	0,37 ... 0,55	0,55 ... 0,8	0,75 ... 1,1	1 ... 1,6
0,18 ... 0,25	0,37	0,75 ... 1,1	0,75 ... 1,1	1,1	1,5	1,6 ... 2,5
0,37	0,55 ... 0,8	1,1 ... 1,5	1,5	1,5 ... 2,2	2,2 ... 3	2,5 ... 4
0,55 ... 0,75	1,1 ... 1,5	2,2 ... 2,5	2,2 ... 3	3	4	4 ... 6,3
1,1 ... 1,5	1,5 ... 2,5	3 ... 4	4 ... 5	4 ... 5,5	5,5 ... 7,5	6,3 ... 10
2,2	3 ... 4	5 ... 7,5	5,5 ... 9	7,5 ... 9	11	10 ... 16
3	5,5	9	11	11 ... 12,5	15	16 ... 20
	5,5 ... 7,5	11 ... 12,5	12,5	15	18,5	20 ... 25

Tripping characteristic

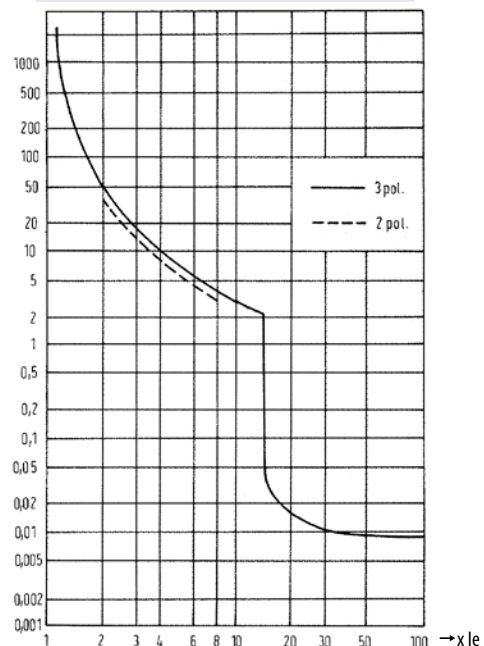

Connection diagram

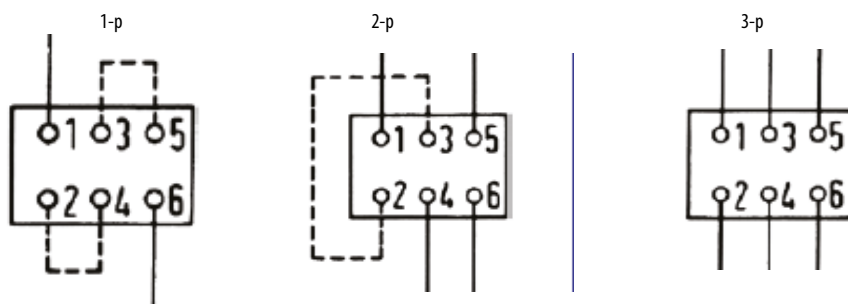

Dimensions

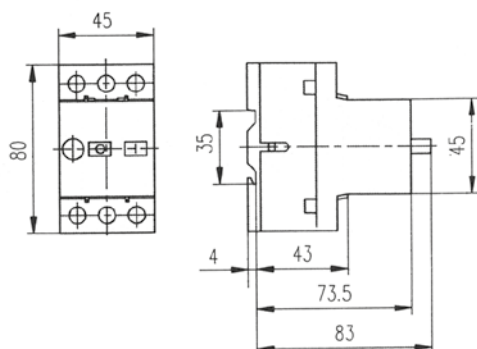



Accessories

Auxiliary switch for lateral mounting PS

Rated insulation voltage U_i	V	500V
Thermal current I_{th}	A	6 A
Rated operational current at AC-15 230V/400V/500V I_e	A	3,5 A / 2 A / 1,5 A
Terminal capacity	mm ²	0,75 - 2,5 mm ²
Tightening torque	Nm	1

Auxiliary switch for lateral mounting PS

Type	Code No.	Wiring diagram	Auxiliary contacts NO, NC	 g	
PS 20	004600160		2,0	30	1/10
PS 01	004600150		0,1	30	1/10
PS 10	004600140		1,0	30	1/10
PS 11	004600130		1,1	30	1/10



PS mounting

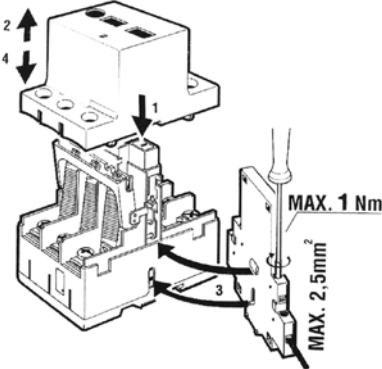

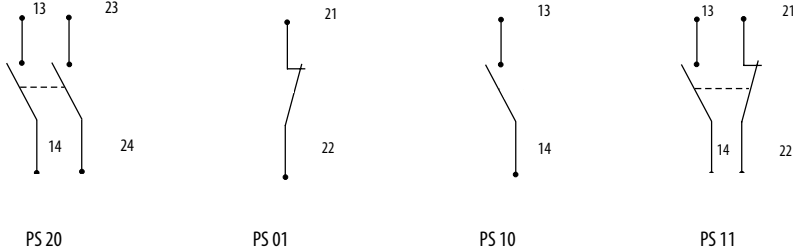

PS designation of contacts



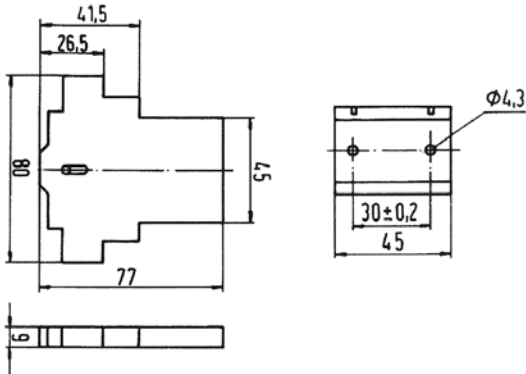

Dimensions



Shunt release

Type	Code No.	Wiring diagram	actuating voltages	 g	
A 230	004600170		220V-240V	30	1/10

**Undervoltage release**

Type	Code No.	Wiring diagram	actuating voltages	 g	
U 230	004600180		220V-240V	30	1/10



**Under-voltage release U, Shunt release A**

Standard		IEC 60947-5-1, UL 60947-5-1
Approvals		CE, UL, EAC
Control voltages U_c	V	230, 400
Rated frequency f	Hz	50/60
Pick-up voltage	$x U_c$	< 0.85
Drop-out voltage		0.7 ... 0.35
Power consumption switch-on operation	VA/W	7.5 / 4.3
operation		3.8 / 1.3
Duty cycle tON/tOFF	%	100
Noise level	dB	< 35
Mechanical and electrical endurance	op. c.	100.000

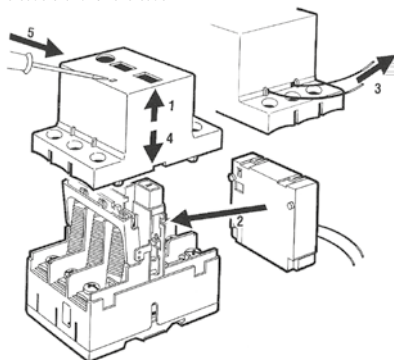
Mounting of Under-voltage release U or shunt release A



Enclosure O Front plate CP

Type	Code No.	IP		
O - 41	004600190	41	250	1
O - 55	004600200	55	250	1
CP - 41	004600210	41	200	1
CP - 55	004600220	55	200	1



O-IP41/55



CP-IP41/55

Dimensions

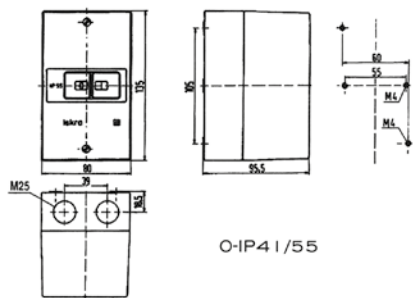

O-IP41/55

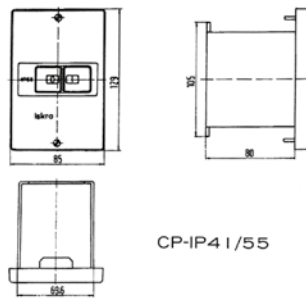

O-IP41/55





CP-IP41/55

CP-IP41/55



Emergency stop push-button

Type	Code No.		
NAT	004600270	15	1/20
NAT-lock	004600280	20	1/20

**Padlocking feature Z**

Type	Code No.		
Z	004600260	30	1/10

**Neutral link NL**

Type	Code No.		
NL	004600330	10	1/10

**Signal lamp SS**

Type	Code No.	Colour		
SS B 400V	004600230	white	10	1/25
SS R 400V	004600240	red	10	1/25
SS Z 400V	004600250	green	10	1/25

