

# Surge arrester ETITEC T WENT group B, EN/IEC/VDE: T1, T2 /I,II/B+C

ETITEC T WENT		
Type	320/12,5	320/25
In accordance with	IEC/EN 61643-11	
Category IEC/EN/VDE	I, II/T1, T2 / B+C	
Max. continuous operating voltage (AC) $U_c$	320V	
Nominal AC voltage $U_o$	230V 50-60 Hz	
TOV immunity $U_T$ (AC)	334 V/5s withstand	
	438 V/120 min safe failure	
Impulse current (10/350) $I_{imp}$	12,5 kA	25 kA
Nominal discharge current (8/20) $I_n$	20 kA	25 kA
Max. discharge current (8/20) $I_{max}$	50 kA	100 kA
Protection level $U_p$ - at $I_n$	<1,5 kV	
Follow current $I_n$	100 A <sub>RMS</sub>	
Response time $t_a$	< 25 ns	
Residual current $I_{pe}$ at $U_{ref}$	< 0,3 mA	
Current source generator	1 mA	
$U_n$ min (MOV)	459 V	459
$U_n$ max (MOV)	561 V	561 V
Voltage step generator*	100 V/s	100 V/s
$U_n$ min (GDT)*	480 V	480 V
$U_n$ max (GDT)*	720 V	720 V
Thermal decoupler	✓	
Torque	3,0 Nm	
Back-up fuse (if mains > 160A)	250 A gG	
Short-circuit current rating $I_{SCCR}$	50 kA / 50 Hz	
Temperature range	- 40°C ...+70°C	
Cross-section of connection wire	min. 6mm <sup>2</sup> ; max. solid, rigid stranded 35mm <sup>2</sup> ; flexible 25mm <sup>2</sup>	
Mounting	indoors on top hat fixing rail 35 mm (EN 60715)	
Degree of protection	IP 20	
Casing material	PA	
Dimensions	2 TE ... 8 TE	
Indication of disconnector operation		
Permissible humidity	5% - 95%	
<b>Additional data for ETITEC T WENT-RC</b>		
Remote signalisation (RC)	✓	
Switching capability (RC)	AC: 250V/0,5A; DC:125V/0,2A	
Cross-section of connection wire (RC)	max. 1.5 mm <sup>2</sup>	
Torque (RC)	0,25 Nm	

Type of network and nr. of SPD poles	
Network	Nr of poles (SPD configuration)
TNC 1 phase	1+0
TNC 3 phase	3+0
TNS 1 phase	2+0 / 1+1
TNS 3 phase	4+0 / 3+1
TT 1 phase	1+1
TT 3 phase	3+1

At TNC, TNS, TT systems with  $U_n=230V$ , recommended  $U_c$  value of SPD is 275V.

Protection configurations for various power systems

ETITEC T WENT limp=25 kA

TN-S Network - Single-phase, 1+0 (T-connection)

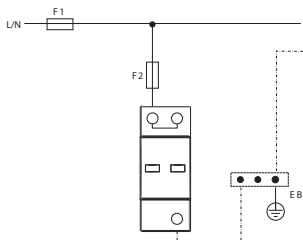

TN-C Network - Single-phase, 1+0 (T-connection)

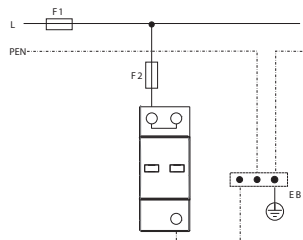

TN-S Network - Single-phase, 2+0 (T-connection)

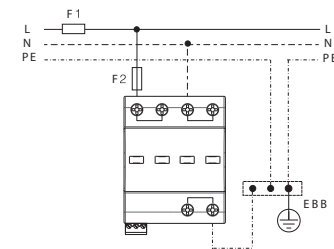

TN-S Network - Three-phase, 4+0 (T-connection)

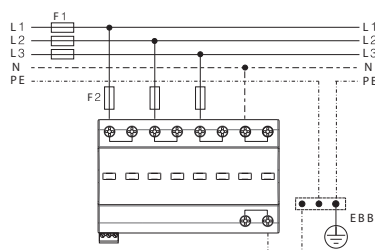

TN-C Network - Three-phase, 3+0 (T-connection)

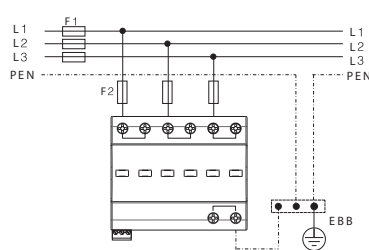

TT Network - Single-phase, 1+1 (T-connection)

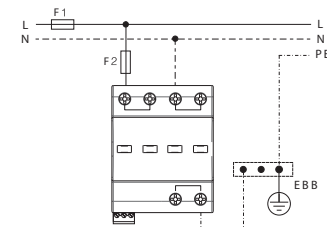

TT Network - Three-phase, 3+1 (T-connection)

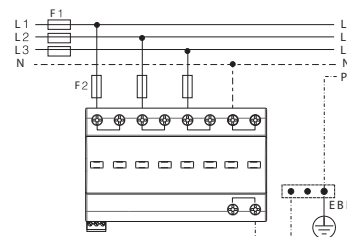

TN-S Network - Single-phase, 1+0 (V-connection)

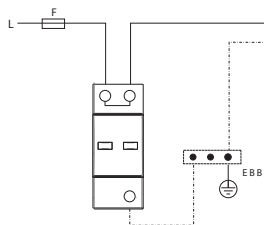

TN-C Network - Single-phase, 1+0 (V-connection)

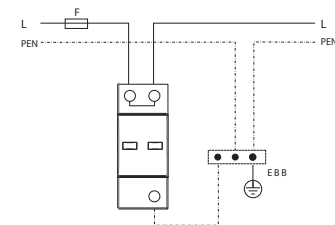

TN-S Network - Single-phase, 2+0 (V-connection)

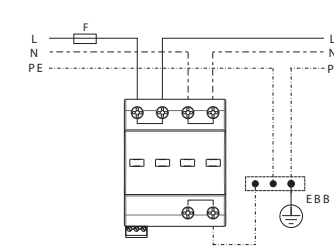

TN-S Network - Three-phase, 4+0 (V-connection)

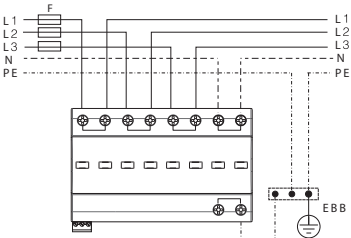

TN-C Network - Three-phase, 3+0 (V-connection)

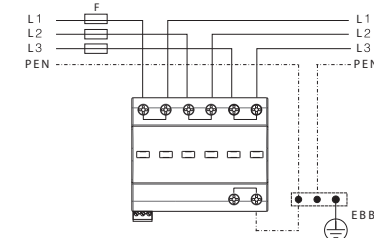

TT Network - Single-phase, 1+1 (V-connection)

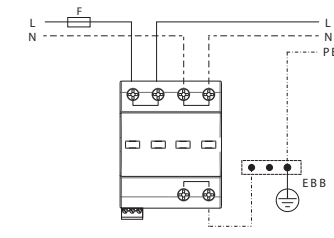

TT Network - Three-phase, 3+1 (V-connection)

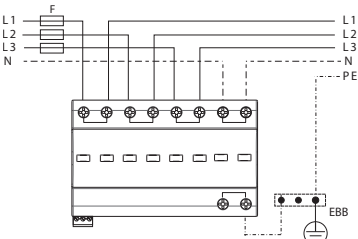

Remote signalization connection / Back-up fuse

Back-up fuse	
F1 > 250 A gG	→ F2 = 250 A gG
F1 ≤ 250 A gG	→ F2 = not needed
F ≤ 100 A gG	

A.C.	250V / 0.5A
D.C.	250V / 0.1A
	125V / 0.2A
	75V / 0.5A

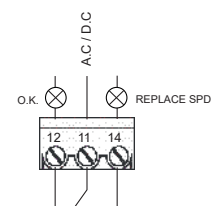

## Technical data

### ETITECT WENT limp=12,5 kA

TN-S Network - Single-phase, 1+0 (T-connection)

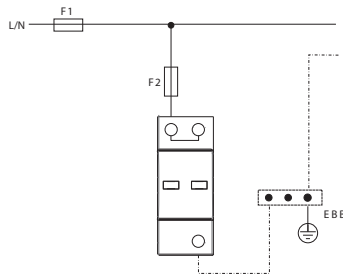

TN-C Network - Single-phase, 1+0 (T-connection)

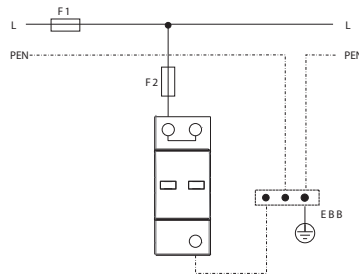

TN-S Network - Single-phase, 2+0 (T-connection)

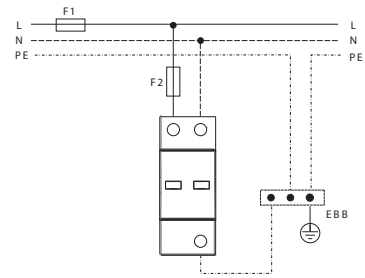

TN-S Network - Three-phase, 4+0 (T-connection)

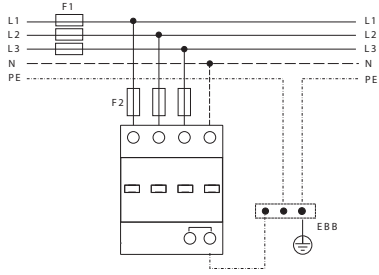

TN-C Network - Three-phase 3+0 (T-connection)

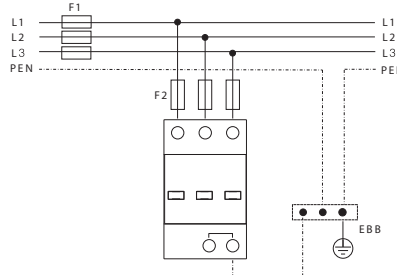

TT Network - Single-phase 1+1 (T-connection)

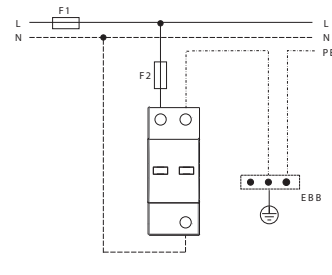

TT Network - Three-phase 3+1 (T-connection)

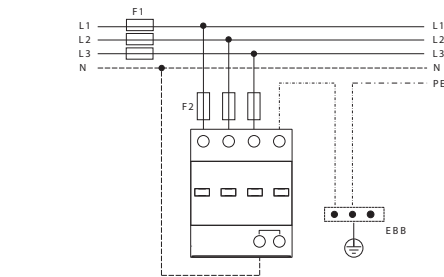

### Remote signalization connection / Back-up fuse

Back-up fuse	
F1 > 250 A gG	→ F2 = 250 A gG
F1 ≤ 250 A gG	→ F2 = not needed

A.C.	250V / 0.5A
D.C.	250V / 0.1A
	125V / 0.2A
	75V / 0.5A

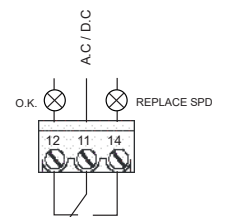

## Dimensions

ETITECT WENT 320/25 1+0 RC  
 ETITECT WENT 320/12,5 1+0 RC  
 ETITECT WENT 320/12,5 2+0 RC  
 ETITECT WENT 320/12,5 1+1 RC

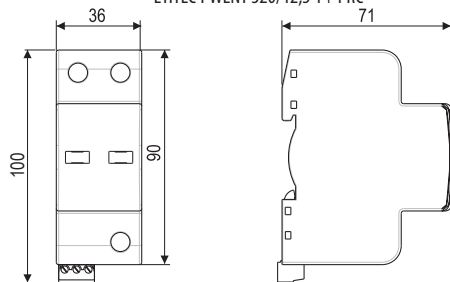

ETITECT WENT 320/12,5 3+0 RC

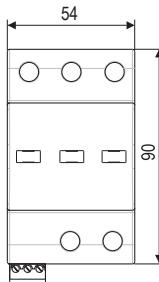

ETITECT WENT 320/12,5 4+0 RC  
 ETITECT WENT 320/12,5 3+1 RC

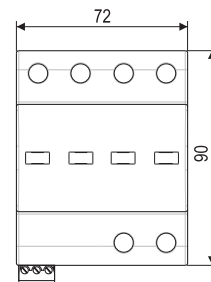

ETITECT WENT 320/25 2+0 RC  
 ETITECT WENT 320/25 1+1 RC

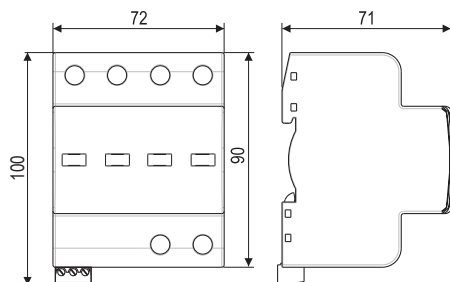

ETITECT WENT 320/25 3+0 RC

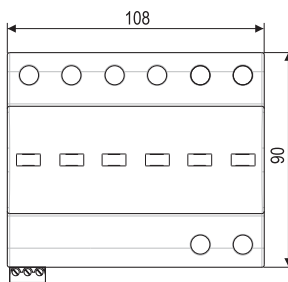

ETITECT WENT 320/25 4+0 RC  
 ETITECT WENT 320/25 3+1 RC

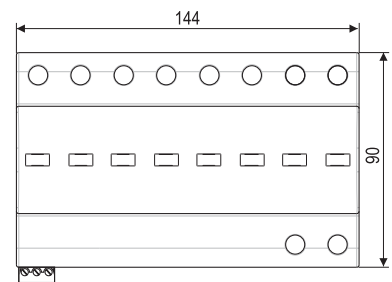

Connection diagram

**ETITECT WENT  $I_{imp}=12,5$  kA**

ETITECT WENT 320/12,5 1+0

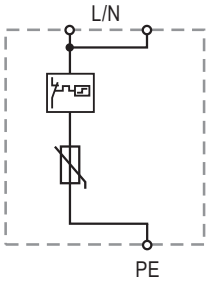

ETITECT WENT 320/12,5 1+0 RC

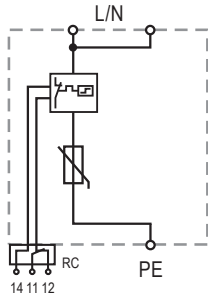

ETITECT WENT 320/12,5 1+1

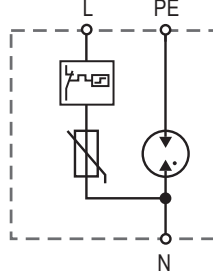

ETITECT WENT 320/12,5 1+1 RC

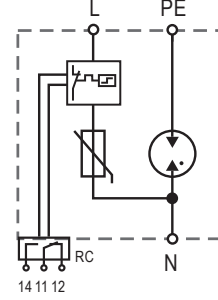

ETITECT WENT 320/12,5 2+0

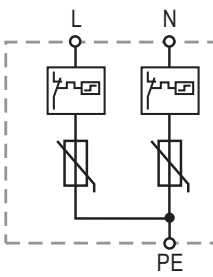

ETITECT WENT 320/12,5 2+0 RC

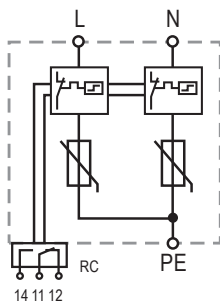

ETITECT WENT 320/12,5 3+0

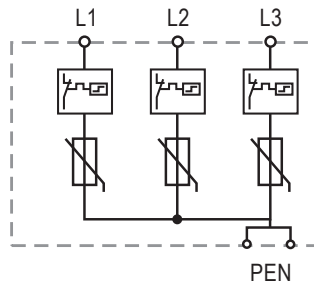

ETITECT WENT 320/12,5 3+0 RC

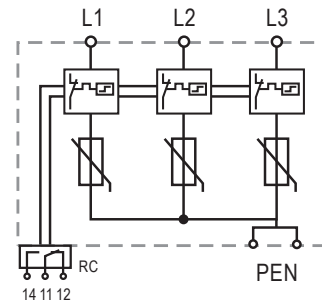

ETITECT WENT 320/12,5 3+1

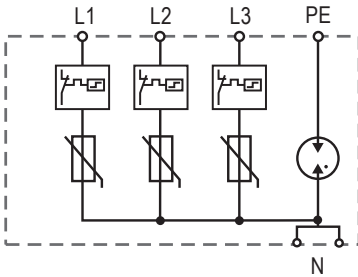

ETITECT WENT 320/12,5 3+1 RC

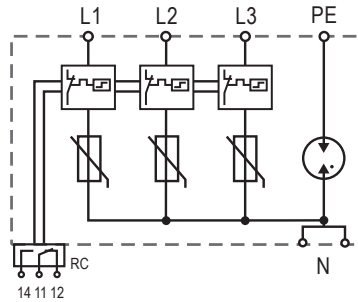

ETITECT WENT 320/12,5 4+0

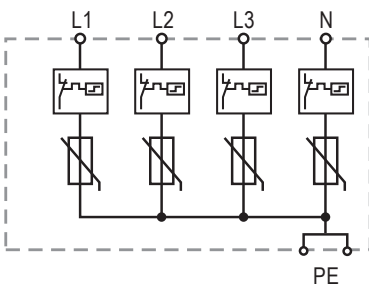

ETITECT WENT 320/12,5 4+0 RC

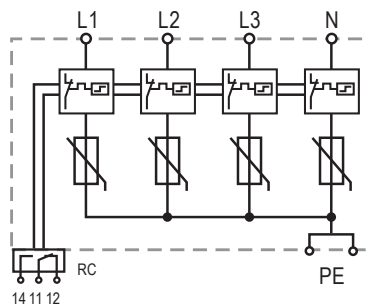

Technical data

**ETITECT WENT Iimp=25 kA**

ETITECT WENT 320/25 1+0

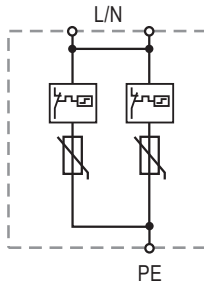

ETITECT WENT 320/25 1+0 RC

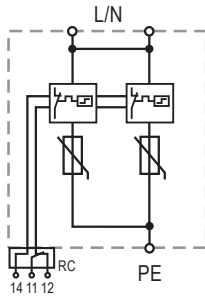

ETITECT WENT 320/25 1+1 RC

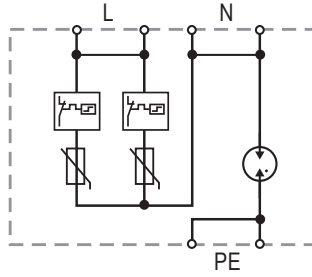

ETITECT WENT 320/25 1+1 RC

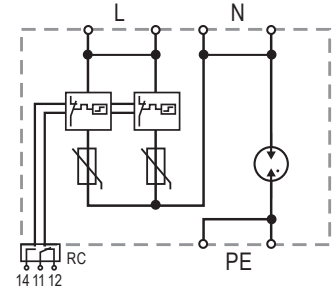

ETITECT WENT 320/25 2+0 RC

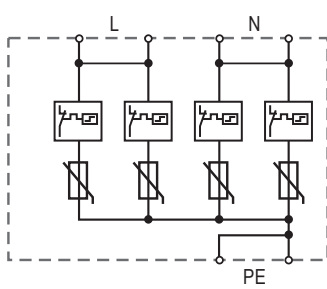

ETITECT WENT 320/25 2+0 RC

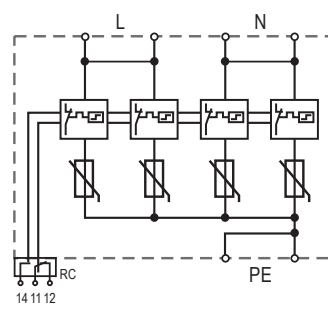

ETITECT WENT 320/25 3+0

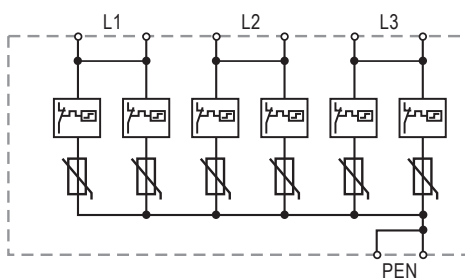

ETITECT WENT 320/25 3+0 RC

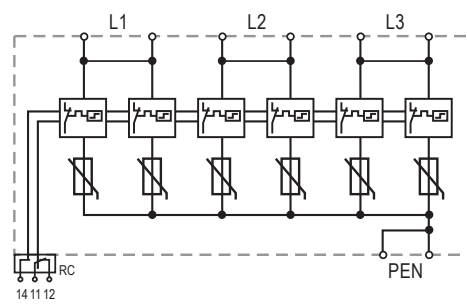

ETITECT WENT 320/25 3+1

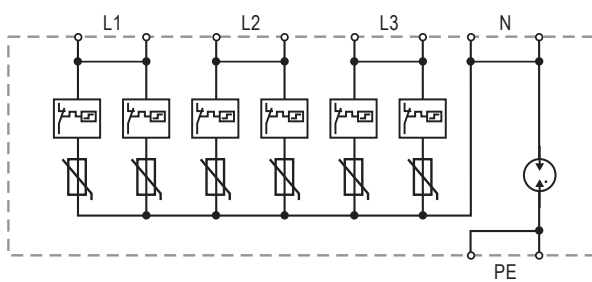

ETITECT WENT 320/25 3+1 RC

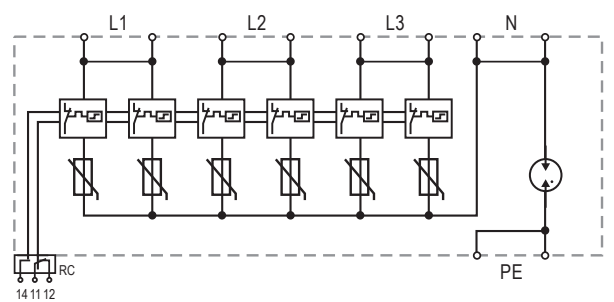

ETITECT WENT 320/25 4+0

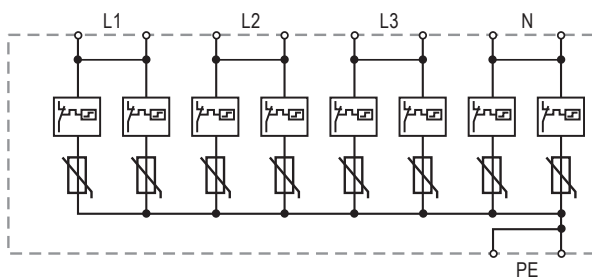

ETITECT WENT 320/25 4+0 RC

