

3PH - ENERGY METER

TECHNICAL MANUAL OF INSTALLATION

ENA3D

ENA3



INDEX

1 - BUTTONS AND INDICATION LEDs:	2
2 - ELECTRICAL DIAGRAM FOR INSTALLATION:.....	2
3 - SET-UP MENU:	3
4 - ENTER THE ALARMS MENU:	5
5 - MEASUREMENTS FUNCTIONS:.....	6
6 - TECHNICAL DATA:	7
7 - TERMINAL CONNECTIONS:	8
8 - DIMENSIONS:	9

REGISTERS MODBUS-RTU TABLE ON REQUEST



!!! IMPORTANT !!! READ THE INSTALLATION MANUAL BEFORE USE.

















THE SAFETY OF THE PRODUCT IS STRICTLY RELATED TO ITS USE THAT HAS TO BE DONE AS SPECIFIED BY THE MANUFACTURER.

1 - BUTTONS AND INDICATION LEDs:

1.1 Buttons:

	- Measurements Menu
	- Value Decrease
	- Value Increase
	- Confirm selection

1.2 Indication LEDs

	V	- Voltage (True RMS)
	A	- Current
	Hz	- Frequency
	cosφ	- Cosφ
	W	- True Power
	VAr	- Volt-Amp Reactive
	VA	- Volt-Amp Apparent
	V% THD	- Total Harmonic Distortion Voltage %
	A% THD	- Total Harmonic Distortion Current %
	Wh	- Watt-hours
	VArh	- Volt-Amp Reactive hours
	IND	- Inductive Load
	CAP	- Capacitive Load
	TEMP	- Temperature (internal temperature sensor)
	1-2-3	- Alarm Relay status
	k	- Multiplier measure x1000
	M	- Multiplier measure x1000000

2 - ELECTRICAL DIAGRAM FOR INSTALLATION:

144x144 - Wiring Diagram:

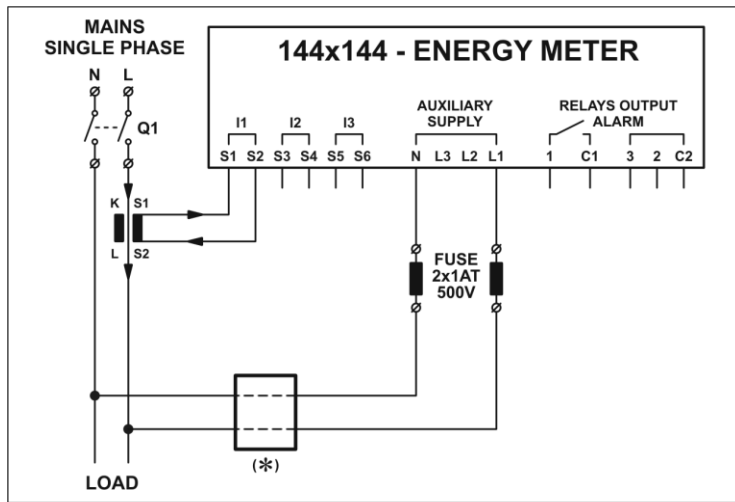

Ratio: $\frac{V_{OUT} = V_{SET}}{V_{LINE}} = \frac{Max. 440V}{V_{LINE}}$

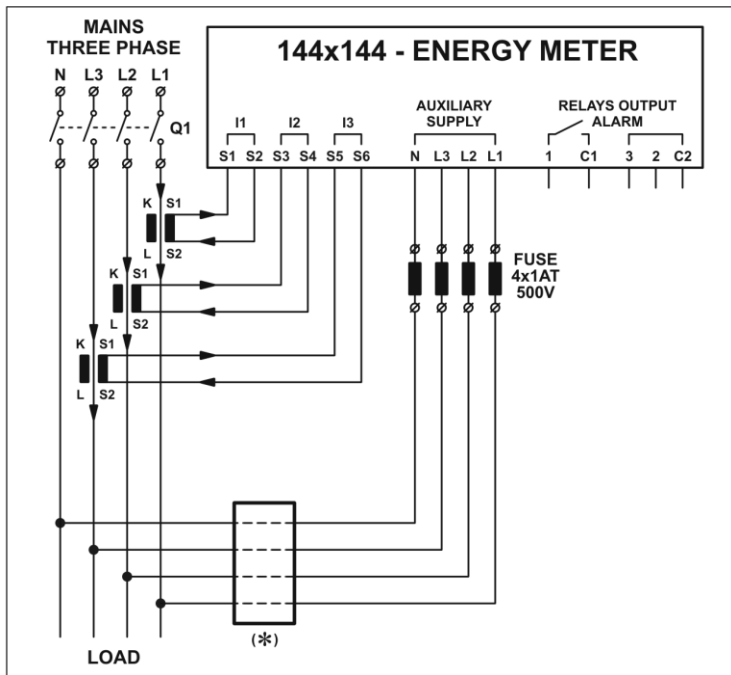

9 MOD - Wiring Diagram:

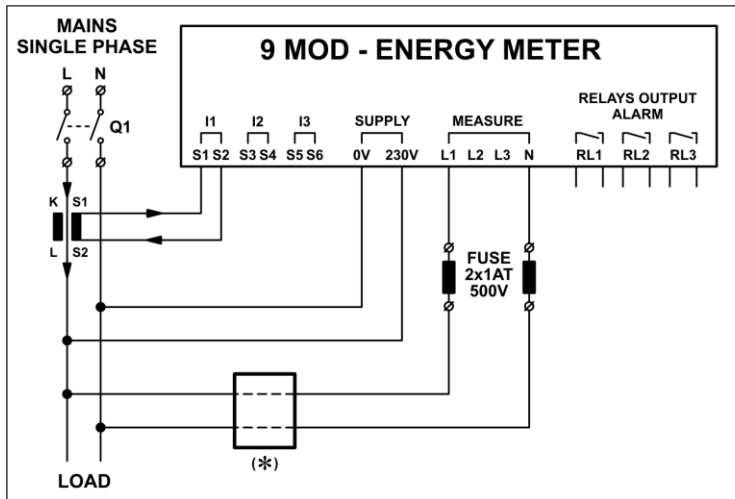

Ratio: $\frac{V_{OUT} = V_{SET}}{V_{LINE}} = \frac{Max. 440V}{V_{LINE}}$

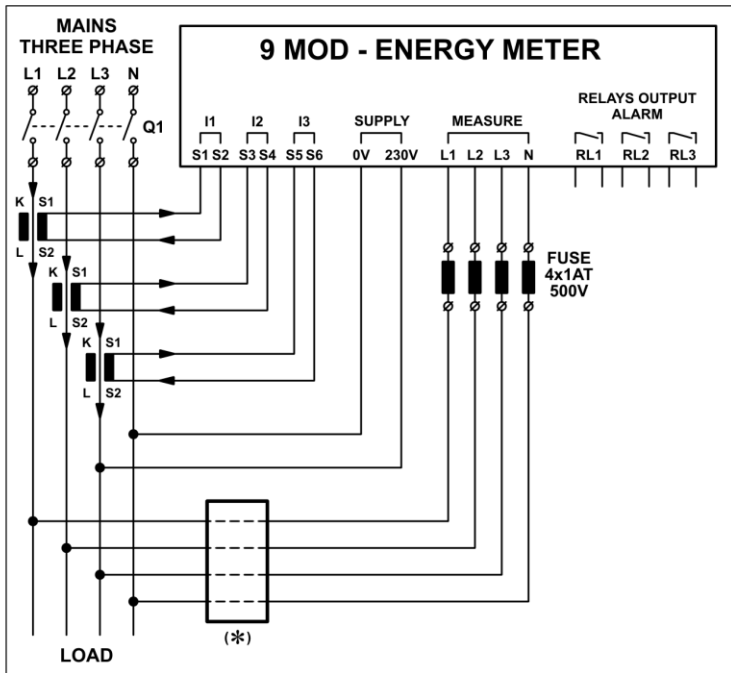

Q1 - The installer has to provide an external disconnection device; this breaker has to be easily reachable and identified as: "disconnection device".









(*) - Without transformer $P.02 = 1$

For higher supply voltage than the supported range, insert one transformer each Phase and set **P.02** with transformer ratio.

3 - SET-UP MENU:

3.1 ENTER THE BASIC SET-UP MENU:



- Press  button for 5 seconds.
- The display will show **SEt**
- Press  button to show the parameters value **P.01**
- Press  button to enter and change the parameter value.
- Press  button to increase or  button to decrease value.
- When the value is OK press  button to return at Basic parameters.
- Press  or  button to scroll the programmable parameters.
- Proceed and program all parameters until the last **P.04**
- After last parameter press again  button to save all data, display will shows **SAU** and exit the Basic set-up Menu. All LEDs will light for a few seconds.
- If the display shows **Err**, an error has happened and was not possible to save the data. Therefore it will be necessary to program again all the parameters on the Basic set-up menu.













Basic Set-up Menu:

PAR.	NAME	DESCRIPTION	RANGE	DEFAULT
P.01	t.cur.	Current transformer ratio.	5 ... 50000	5
P.02	r.tu.	Voltage transformer ratio (ex. $V_{LINE} / V_{SET} = 500 / 400 = 1.25$)	0.40 ... 100	1.00
P.03 ⁽¹⁾	int.	Power Reading Interval.	60s ... 360s	90s
P.04 ⁽²⁾	AUEr.	Average time filter Value.	1 ... 20	4

(1) - Parameter **P.03** adjusts the time window width for the integration of current and power maximum demand.

(2) - Parameter **P.04** allows to modify the stabilising effect that the Average function applies to all readings.

3.2 ENTER THE ADVANCED MENU:

- Press the  button for 5 seconds.
- The display will show **SEt**
- Press   both buttons for 2 seconds until the display shows **SEtA**
- Press  button to show **A.01**
- Press  button to enter and change the parameter value.
- Press  button to increase or  button to decrease value.
- When the value is OK press  button to return at Advanced parameters.
- Press  or  to scroll the programmable parameters.
- Press  button to increase or  button to decrease the value.
- Proceed and program all parameters until the last **A.08**
- After last parameter press again  button to save all data, display will shows **SAU** and exit the Advance Menu. All LEDs will flash for a few seconds.
- If the display shows **Err**, an error has happened and was not possible to save the data. Therefore it will be necessary to program again all the parameters on the Advance Menu.

Advance Set-up Menu:

PAR.	NAME	DESCRIPTION	RANGE	DEFAULT
------	------	-------------	-------	---------

A.01	-	Mains Connection	0 = Three-Phase	1 = Single-Phase	0 ... 1	0			
A.02	UOLt.	Voltage Reference for Measures (steps of 5)	L/L - Three-Phase L/N - Single-Phase		220 ... 440	400			
A.03	Ct.L.1	Sense of CT current	1 = CT on L1 Direct	2 = CT on L1 Inverse	1 ... 2	1			
	Ct.L.2		1 = CT on L2 Direct	2 = CT on L2 Inverse					
	Ct.L.3		1 = CT on L3 Direct	2 = CT on L3 Inverse					
A.04	-	Frequency	1 = 50 HZ	2 = 60 HZ	1 ... 2	1			
A.05	Addr.	Serial interface TTL	0 = Disable	1 ... 99 = Enable	0 ... 99	1*			
A.06	-	Temperature scale	0 = °C	1 = °F	0 ... 1	0			
A.07	-	List of settable Alarms (view details on the next Alarms Menu)							
A.08	-	Serial Protocol Type	0	Proprietary	9600 Bds	EVEN	1 Bit Stop	0 ... 18	0
			1	Modbus	19200 Bds	EVEN	1 Bit Stop		
			2	Modbus	9600 Bds	EVEN	1 Bit Stop		
			3	Modbus	4800 Bds	EVEN	1 Bit Stop		
			4	Modbus	2400 Bds	EVEN	1 Bit Stop		
			5	Modbus	1200 Bds	EVEN	1 Bit Stop		
			6	Modbus	19200 Bds	ODD	1 Bit Stop		
			7	Modbus	9600 Bds	ODD	1 Bit Stop		
			8	Modbus	4800 Bds	ODD	1 Bit Stop		
			9	Modbus	2400 Bds	ODD	1 Bit Stop		
			10	Modbus	1200 Bds	ODD	1 Bit Stop		
			11	Modbus	19200 Bds	NONE	1 Bit Stop		
			12	Modbus	9600 Bds	NONE	1 Bit Stop		
			13	Modbus	4800 Bds	NONE	1 Bit Stop		
			14	Modbus	2400 Bds	NONE	1 Bit Stop		
			15	Modbus	1200 Bds	NONE	1 Bit Stop		
			16	Proprietary	9600 Bds	NONE	1 Bit Stop		
			17	Proprietary	4800 Bds	NONE	1 Bit Stop		
18	Proprietary	9600 Bds	ODD	1 Bit Stop					











* The values 1 to 99 indicate the device number when the units are connect on a serial interface.







3.3 TO SET DEFAULT PARAMETERS:

- In **SEtA** parameter, press all buttons together     for 5 seconds, on display will shows **SAU**
Now the device will restart.

ATTENTION: All settings made on the device will be lost and all steps will be restored to default setting.

4 - ENTER THE ALARMS MENU:

- Press  button for 5 seconds.
- The display will show **SEt**
- Press   both buttons for 2 seconds until the display shows **SEtA**
- Press  button several time until the display shows **A. 07**
- Press  button to enter in list of settable Alarms, display shows **A.-HU**
- Press  or  buttons to scroll Alarms that can be set: **A.-HU > A.-LU > A.-H I > A.ot > A.-tH > A.-CS > A.-Fr**
- Press  button to display the values set for the selected Alarm.
- The display shows **En.b**
- Press  or  buttons to scroll Alarm values that can be set: **En.b > d. t. > d. u. > rEL. > L inE (only for A.-H I)**
- Press  button to enter and change the desired Alarm values.

- m) Press  button to increase or  button to decrease value.
- n) When the value is OK press  button to save value and return at Alarm values.
- o) After setting all the desired Alarm values press  button to return at list of settable Alarms.
- p) After setting all the desired settable Alarms press  button to return at Advanced parameters.
- q) Press  button to get another Advanced parameter.
- r) After last parameter press again  button to save all data, display will shows **SAU** and exit the Advance Menu. All LEDs will flash for a few seconds.
- s) If the display shows **Err**, an error has happened and was not possible to save the data. Therefore it will be necessary to program again all the parameters on the Advance Menu.

Alarms Set-up:

PAR.	Description	Range Enable E.nb (default)	Delay Time d. t. (default)	Value time d. u. (default)	Alarm Relay Set r.EL. (default)	Select Phase L inE (default)
R.-HU	Too High Voltage	0 = disable 110 ... 150 (110)	1 ... 240 (10)	Min / Sec (Sec)	0 = disable 1-2-3 (1)	-
R.-LU	Too Low Voltage	0 = disable 80 ... 95 (95)	1 ... 240 (10)	Min / Sec (Sec)	0 = disable 1-2-3 (1)	-
R.-HI	Too High Current	50 ... 500000 (100)	1 ... 240 (10)	Min / Sec (Sec)	0 = disable 1-2-3 (1)	0 = ALL (0) 1 = L1 2 = L2 3 = L3
R.-ot	Over Temperature	0 = disable 30° ... 60° (60°)	1 ... 240 (10)	Min / Sec (Sec)	0 = disable 1-2-3 (1)	-
R.-tH	THD % I	0 = disable 5 ... 200 (120)	1 ... 240 (10)	Min / Sec (Sec)	0 = disable 1-2-3 (1)	-
R.-CS	Low Cosφ	0 = disable 0.5 ... 0.95 (0.90)	1 ... 240 (10)	Min / Sec (Sec)	0 = disable 1-2-3 (1)	-
R.-Fr	Discard Freq. Hz	0 = disable ±1 ... ±5 (5)	1 ... 240 (10)	Min / Sec (Sec)	0 = disable 1-2-3 (1)	-

Alarms Fixed:

















Display Code	Description	Intervention Parameter
R.PS	Set-up parameters error	The set-up parameters read by the EEPROM aren't correct. To restore is necessary the re-set made by the user.
R.PC	Adjustment/setting parameters error	The setting parameters read by the EEPROM aren't correct. The device operates with the default parameters. There could be error in the calculated measures. The user can't do the setting. It is necessary to return the unit to the manufacturer.
R.PU	Parameters error	The setting parameters read by the EEPROM aren't correct (set Cosφ, sensitivity, operation mode). To reset is necessary to contact the manufacturer.
R.EE	Cancellation EPROM error	Only in the testing phase you can see if the EEPROM doesn't operates correctly. Is necessary to contact the manufacturer.

Pressing the  button the visual alarm can temporarily be cancelled, and the readings can be shown to verify the causes of the alarms.

5 - MEASUREMENTS FUNCTIONS:

- a) If the load are inductive  **IND** or capacitive  **CAP**.

On $\text{Cos}\phi$ value indication, if the decimal point on last digit (from left) is flashing, this is because the system working as Generator or the sense of current is inverted (verify correct CT connection or modify parameter $R.03$).

- b) Press  button to scroll on available measurements indicated by the related LED.
- c) If a $\star k$ is on the value must be multiplied $\times 1000$, instead If a $\star M$ is on the value must be multiplied $\times 1000000$.
- d) Press   both buttons to scroll measure automatically every 3s, press  button for stop scroll.
- e) While viewing one of these measures: **V - A - $\text{Cos}\phi$ - W - VAr - VA - %THDV - %THDI** if press  button for 1s, all displays and shows the average value measured.
- f) While viewing one of these measures: **V - A - %THDV - %THDI - TEMP** if press   both buttons for 1s, flashes the relative Led and display shows the maximum value measured.
- g) While select **Wh** measure, the display shows the value for each Phases if $R.01$ set in Three-Phase mode or one Phase if $R.01$ set in Single-Phase mode, press  it shows the total **Wh** for 5s.
Press   both buttons for 15s to reset all **Wh** values.
- h) While select **VArh** measure, the display shows the value for each Phases if $R.01$ set in Three-Phase mode or one Phase if $R.01$ set in Single-Phase mode, press  it shows the total **VArh** for 5s.
Press   both buttons for 15s to reset all **VArh** values.
- i) Only if $R.01$ set in Three-Phase mode, while select **V** measure, the display shows the value **L-n** for each Phase, press  it shows the phase voltages.
Press for more than 5s  to switch from **L-n** to **L-L** and set this as default measure value and vice versa.
- l) While select **TEMP** measure, the display shows the current working temperature, press and hold  it shows the total device worked hours.

5.1 MEASURE DETAILS:

Measuring Type:	True RMS	
$\text{Cos}\phi$ (L/L)	-	0.00 to 1.00 $\pm 1\%$
Voltage (N/Lx)	VA~	100 to 280 $\pm 1\%$
Voltage (L/L)	VA~	180 to 490 $\pm 1\%$
Current (CT)	A	0.05 to 5.5 $\pm 0.5\%$
Active Power (Lx)	W	Class 1
Reactive Power (Lx)	VAr	Class 1
Apparent Power (Lx)	VA	Class 1
THD of Volt or Current	%	0 to 255
Work Hours	H	0 to 9999 (with multiplier)
Ambient Temperature	$^{\circ}\text{C}$	0/+60 $^{\circ}\text{C}$ (or $^{\circ}\text{F}$)

MAX VALUE:

The data recording happens every 2 seconds, then after 32 seconds, the micro calculates the average of the 16 different recording and, if above the stored max value, this goes to overwrite it and becomes effectively the new max value.

This is to avoid that a single abnormal pike can false the real situation recording an extraordinary and occasional max value. For the max Temperature the data is related to the single reading not to the average.

AVERAGE VALUE:

The data capture occurs every 2 seconds, for example if $P.04=10$ the average value is calculated on 20 seconds.

After power on, during the first 15 minutes, the recording of the max values is disabled.

6 - TECHNICAL DATA:

Supply Circuit		
	144x144	9 Modules

Supply Voltage	3x400V~ +N	230V~ L/N
Operating Limits	-10% ... +10% Ue	
Rated Frequency	50 or 60Hz	
Power Consumption L/N - 230V~	4 VA	
Immunity time for Microbreakings	< 50ms	
Measurement/Overvoltage Category	Class II	

Current Input	
Rated Current	5A
Operating Limits	0.050 ... 5.5A
Overload Capacity	1.1Ie
Overload Peak	10Ie for 500ms
Measurement/Overvoltage Category	Class II

Reading and Control Range	
Voltage Reading Limits	195...460 V~ 2 ... 480 V~
Current Reading Limits	0.050...5A
Type of Current and Voltage Readings	TRMS
FFT - Harmonic Spectrum	THD% - 64st

Relay Outputs	
Number of Outputs	3
Contact Arrangement	1NO
Contacts Capacity	8A – 250V~ (AC1)
Maximum Capacity the Common Contacts	8A (C1) - 10A (C2) 8A
Insulating Category/Rated Voltage VDE0110	C/250 - B/400
Maximum Switching Voltage	250V~
Electrical Contact Life	20 x 10 ⁶ ops
Mechanical Contact Life	100 x 10 ³ ops

Enclosure and Connections	
Cable Type for connection	Only 90°C - 1.5/2.5mm ² - 16/14 AWG
Working Temperature	-20 / +60 °C
Storage temperature	-30 / +70 °C
Operating Altitude	Up to 2000m
Pollution Degree	2
Electrical Insulation – Mains/Contact	4 kV
Protection Degree	IP41 Front - IP20 Terminals
Relative Humidity w/o Condensation	95 RH%
	144x144 9 Modules
Enclosure Version	Flush Mount DIN Rail
Dimensions	149 x 149 x 60mm 157 x 89 x 60mm
Weight	650g 480g

Serial Interface	
TTL	Standard
Communication Protocol	Proprietary / MODBUS RTU
Connector Type	RJ11

EC Directives: - 2006/95/EC - Low Voltage
- 2004/108/EC - EMC

Norms Compliance: CE marking

- IEC EN 55022 - IEC EN 61000-4-2 - IEC EN 61000-4-3 - IEC EN 61000-4-4 - IEC EN 61000-4-5
- IEC EN 61000-4-6 - IEC EN 61000-4-11 - IEC EN 61000-6-2 - IEC EN 61000-6-4 - IEC EN 61010-1
- IEC EN 61010-2-030

7 - TERMINAL CONNECTIONS:

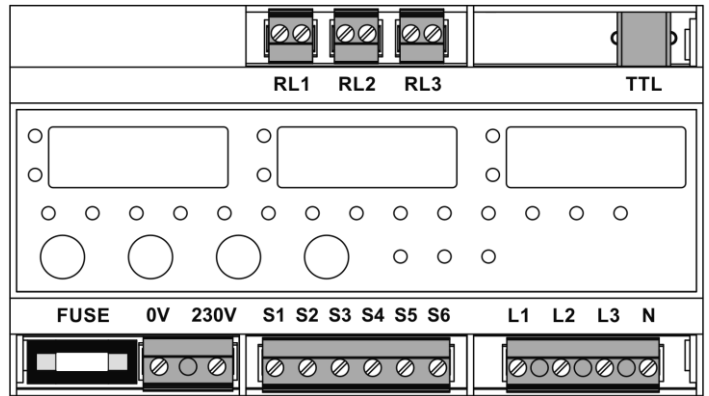
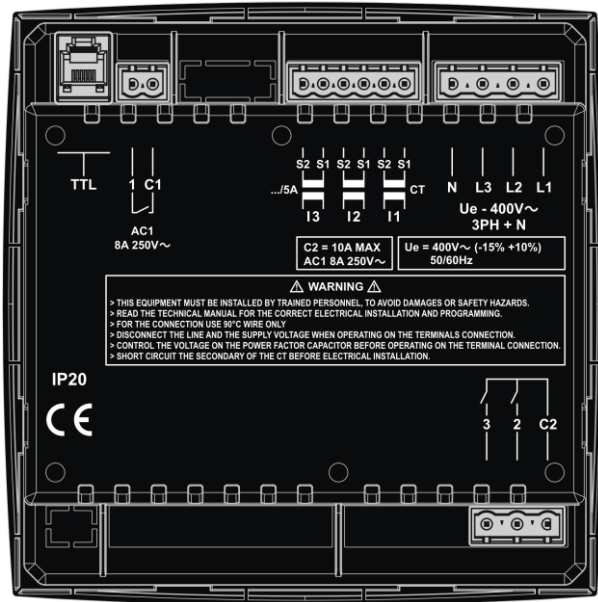

8 - DIMENSIONS:

144x144 - MODEL

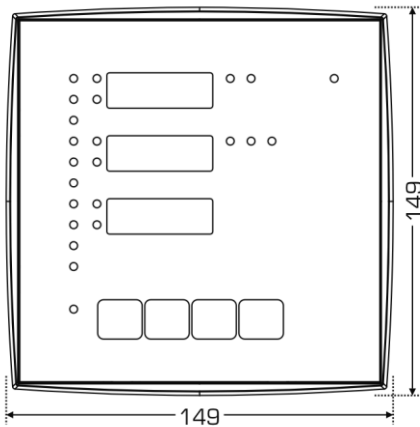

FRONT VIEW

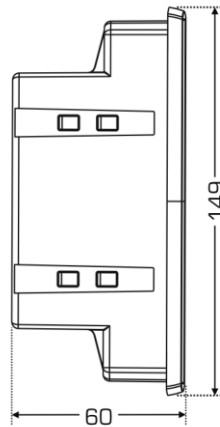

SIDE VIEW

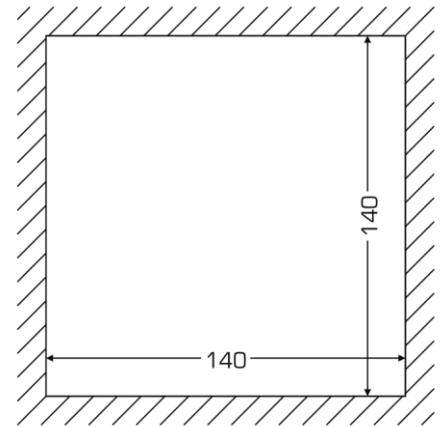

PANEL HOLE

9 MODULE - MODEL

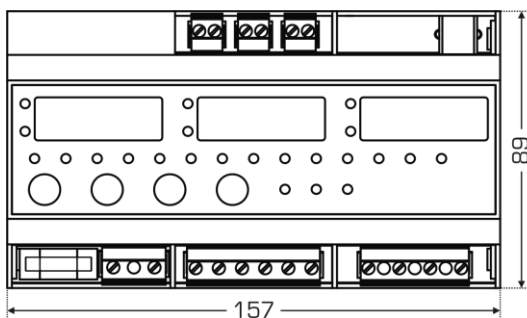

FRONT VIEW

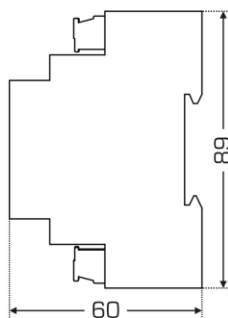

SIDE VIEW

CLEANING OF THE UNIT:

If necessary clean the device with a soft cloth dampened with water.

This operation must be done with the instrument switched off and disconnected from any power source.